

# Needle roller bearings



® SKF is a registered trademark of the SKF Group.

© SKF Group 2010

The contents of this publication are the copyright of the publisher and may not be reproduced (even extracts) unless prior written permission is granted. Every care has been taken to ensure the accuracy of the information contained in this publication but no liability can be accepted for any loss or damage whether direct, indirect or consequential arising out of the use of the information contained herein.

**PUB PSD/P1 06003/1 EN** · March 2010

This publication supersedes publication  
PUB PSD/P1 06003 EN.

Printed in Germany on environmentally friendly  
paper.

|                                                         |     |
|---------------------------------------------------------|-----|
| Principles of bearing selection and application .....   | 13  |
| Needle roller and cage assemblies .....                 | 57  |
| Drawn cup needle roller bearings .....                  | 75  |
| Needle roller bearings with machined rings.....         | 97  |
| Alignment needle roller bearings .....                  | 141 |
| Needle roller thrust bearings and bearing washers ..... | 151 |
| Combined needle roller bearings.....                    | 169 |
| Needle roller bearing components .....                  | 195 |
| Track runner bearings .....                             | 215 |

1

2

3

4

5

6

7

8

9

# Contents

|                                                                                          |            |
|------------------------------------------------------------------------------------------|------------|
| <b>Foreword</b> .....                                                                    | <b>5</b>   |
| <b>Unit conversions</b> .....                                                            | <b>7</b>   |
| <b>SKF – the knowledge engineering company</b> .....                                     | <b>8</b>   |
| <b>1 Principles of bearing selection and application</b> .....                           | <b>13</b>  |
| Bearing terminology.....                                                                 | 14         |
| Bearing types.....                                                                       | 17         |
| Bearing life and loads.....                                                              | 32         |
| Friction.....                                                                            | 34         |
| Speeds.....                                                                              | 35         |
| Bearing data – general.....                                                              | 36         |
| Application of bearings.....                                                             | 48         |
| Lubrication.....                                                                         | 52         |
| <b>2 Needle roller and cage assemblies</b> .....                                         | <b>57</b>  |
| Product tables                                                                           |            |
| 2.1 Needle roller and cage assemblies .....                                              | 64         |
| <b>3 Drawn cup needle roller bearings</b> .....                                          | <b>75</b>  |
| Product tables                                                                           |            |
| 3.1 Drawn cup needle roller bearings .....                                               | 82         |
| <b>4 Needle roller bearings with machined rings</b> .....                                | <b>97</b>  |
| Product tables                                                                           |            |
| 4.1 Needle roller bearings with machined rings with flanges, without an inner ring ..... | 106        |
| 4.2 Needle roller bearings with machined rings with flanges, with an inner ring .....    | 122        |
| 4.3 Needle roller bearings with machined rings without flanges, without an inner ring .. | 134        |
| 4.4 Needle roller bearings with machined rings without flanges, with an inner ring ..... | 138        |
| <b>5 Alignment needle roller bearings</b> .....                                          | <b>141</b> |
| Product tables                                                                           |            |
| 5.1 Alignment needle roller bearings without an inner ring .....                         | 146        |
| 5.2 Alignment needle roller bearings with an inner ring.....                             | 148        |
| <b>6 Needle roller thrust bearings and bearing washers</b> .....                         | <b>151</b> |
| Product tables                                                                           |            |
| 6.1 Needle roller and cage thrust assemblies and appropriate washers.....                | 162        |
| 6.2 Needle roller thrust bearings with a centring spigot and appropriate washers.....    | 166        |

|                                                                                |            |
|--------------------------------------------------------------------------------|------------|
| <b>7 Combined needle roller bearings .....</b>                                 | <b>169</b> |
| Product tables                                                                 |            |
| 7.1 Needle roller / angular contact ball bearings .....                        | 174        |
| 7.2 Needle roller / thrust ball bearings, full complement thrust bearing ..... | 184        |
| 7.3 Needle roller / thrust ball bearings, thrust bearing with a cage .....     | 186        |
| 7.4 Needle roller / cylindrical roller thrust bearings .....                   | 192        |
| <b>8 Needle roller bearing components .....</b>                                | <b>195</b> |
| Product tables                                                                 |            |
| 8.1 Needle roller bearing inner rings .....                                    | 200        |
| 8.2 Needle rollers .....                                                       | 206        |
| 8.3 Radial shaft seals with low cross sectional height .....                   | 212        |
| <b>9 Track runner bearings .....</b>                                           | <b>215</b> |
| Product tables                                                                 |            |
| 9.1 Support rollers without flange rings, without an inner ring .....          | 226        |
| 9.2 Support rollers without flange rings, with an inner ring .....             | 228        |
| 9.3 Support rollers with flange rings, with an inner ring .....                | 230        |
| 9.4 Cam followers .....                                                        | 252        |
| <b>Product index .....</b>                                                     | <b>258</b> |



The SKF brand now stands for more than ever before, and means more to you as a valued customer.

While SKF maintains its leadership as the hallmark of quality bearings throughout the world, new dimensions in technical advances, product support and services have evolved SKF into a truly solutions-oriented supplier, creating greater value for customers.

These solutions encompass ways to bring greater productivity to customers, not only with breakthrough application-specific products, but also through leading-edge design simulation tools and consultancy services, plant asset efficiency maintenance programmes, and the industry's most advanced supply management techniques.

The SKF brand still stands for the very best in rolling bearings, but it now stands for much more.

**SKF – the knowledge engineering company**

# Foreword

Many bearing arrangements have limited radial space, but require bearings having a high load carrying capacity and a high degree of stiffness. SKF needle roller bearings with their low cross section fulfil these requirements. They also provide an economical solution to these challenges if the shaft or housing bore can serve as raceways.

SKF track runner bearings are an excellent choice for all types of cam drives, tracks, conveyor systems etc. where guidance is required.

For motorsport applications, SKF Racing has been using customized, high-performance needle roller bearings for many years. These special needle roller bearings are used in the most demanding Formula One applications, such as gearboxes. Using different advanced materials, coatings and designs, SKF's advanced engineering knowledge can improve the performance and reliability of virtually any application.

SKF supplies needle roller bearings as well as track runner bearings in many designs, series and sizes, which make them appropriate for various operating conditions.

This catalogue presents the current standard assortment of SKF needle roller bearings, track runner bearings and radial shaft seals with low cross sectional height.

## Structure of the catalogue

The catalogue starts with general product information followed by nine main chapters, which are marked with numbered blue tabs in the right margin:

- Chapter 1 provides bearing terminology and types as well as selection, design and application recommendations.

- Chapters 2 to 8 describe the various needle roller bearing types and their associated components. Each chapter contains descriptions of the products as well as product tables, which list data for selecting a bearing and designing the bearing arrangement.
- Similarly, chapter 9 presents the various designs and series of track runner bearings, incorporating needle or cylindrical rollers.

The index at the end lists all products presented in this catalogue in alphanumeric order.

## About the data in this catalogue

The data in this catalogue relates to SKF's state-of-the-art technology as of mid-2009. The data may differ from that shown in earlier catalogues because of revised methods of calculation, redesign or technological developments.

SKF reserves the right to make continuing improvements to SKF products with respect to materials, design and manufacturing methods, as well as changes necessitated by technological developments.

The units used in this catalogue are in accordance with ISO (International Organization for Standardization) standard 1000:1992, and SI (Système International d'Unités). A table for unit conversions can be found on **page 7**.

## Other SKF catalogues

The total SKF product portfolio is much broader than only needle roller bearings and track runner bearings. Product information is also available via the SKF website at [www.skf.com](http://www.skf.com). The *SKF Interactive Engineering Catalogue* provides not only product information, but also online

calculation tools, CAD drawings in various formats, and search and selection functions.

The main printed SKF catalogues are:

- General Catalogue
- High-precision bearings
- Y-bearings and Y-bearing units
- Spherical plain bearings and rod ends
- Bearing housings
- Slewing bearings
- Linear motion standard range
- SKF Maintenance and Lubrication Products
- Centralized lubrication systems
- Industrial shaft seals
- SKF Power transmission products

For more information about SKF products and services, contact your local SKF representative or SKF Authorized Distributor.

### **More advantages**

SKF aims to deliver industry-leading, high value products, services and knowledge-engineered solutions. Many capabilities contribute to the overall value customers receive in making SKF their supplier of choice, such as:

- simplified bearing selection
- short delivery times
- worldwide availability
- commitment to product innovation
- state-of-the-art application solutions
- extensive engineering and technology knowledge in virtually every industry



## Unit conversions

| Quantity                | Unit                   | Conversion          |                          |                |                             |
|-------------------------|------------------------|---------------------|--------------------------|----------------|-----------------------------|
| <b>Length</b>           | inch                   | 1 mm                | 0,03937 in               | 1 in           | 25,40 mm                    |
|                         | foot                   | 1 m                 | 3,281 ft                 | 1 ft           | 0,3048 m                    |
|                         | yard                   | 1 m                 | 1,094 yd                 | 1 yd           | 0,9144 m                    |
|                         | mile                   | 1 km                | 0,6214 mile              | 1 mile         | 1,609 km                    |
| <b>Area</b>             | square inch            | 1 mm <sup>2</sup>   | 0,00155 sq.in            | 1 sq.in        | 645,16 mm <sup>2</sup>      |
|                         | square foot            | 1 m <sup>2</sup>    | 10,76 sq.ft              | 1 sq.ft        | 0,0929 m <sup>2</sup>       |
| <b>Volume</b>           | cubic inch             | 1 cm <sup>3</sup>   | 0,061 cub.in             | 1 cub.in       | 16,387 cm <sup>3</sup>      |
|                         | cubic foot             | 1 m <sup>3</sup>    | 35 cub.ft                | 1 cub.ft       | 0,02832 m <sup>3</sup>      |
|                         | imperial gallon        | 1 l                 | 0,22 gallon              | 1 gallon       | 4,5461 l                    |
|                         | U.S. gallon            | 1 l                 | 0,2642 U.S. gallon       | 1 U.S. gallon  | 3,7854 l                    |
| <b>Velocity, speed</b>  | foot per second        | 1 m/s               | 3,28 ft/s                | 1 ft/s         | 0,30480 m/s                 |
|                         | mile per hour          | 1 km/h              | 0,6214 mile/h (mph)      | 1 mile/h (mph) | 1,609 km/h                  |
| <b>Mass</b>             | ounce                  | 1 g                 | 0,03527 oz               | 1 oz           | 28,350 g                    |
|                         | pound                  | 1 kg                | 2,205 lb                 | 1 lb           | 0,45359 kg                  |
|                         | short ton              | 1 tonne             | 1,1023 short ton         | 1 short ton    | 0,90719 tonne               |
|                         | long ton               | 1 tonne             | 0,9842 long ton          | 1 long ton     | 1,0161 tonne                |
| <b>Density</b>          | pound per cubic inch   | 1 g/cm <sup>3</sup> | 0,0361 lb/cub.in         | 1 lb/cub.in    | 27,680 g/cm <sup>3</sup>    |
| <b>Force</b>            | pound-force            | 1 N                 | 0,225 lbf                | 1 lbf          | 4,4482 N                    |
| <b>Pressure, stress</b> | pounds per square inch | 1 MPa               | 145 psi                  | 1 psi          | 6,8948 × 10 <sup>3</sup> Pa |
| <b>Moment</b>           | inch pound-force       | 1 Nm                | 8,85 in.lbf              | 1 in.lbf       | 0,113 Nm                    |
| <b>Power</b>            | foot-pound per second  | 1 W                 | 0,7376 ft lbf/s          | 1 ft lbf/s     | 1,3558 W                    |
|                         | horsepower             | 1 kW                | 1,36 HP                  | 1 HP           | 0,736 kW                    |
| <b>Temperature</b>      | degree                 | Celsius             | $t_C = 0,555 (t_F - 32)$ | Fahrenheit     | $t_F = 1,8 t_C + 32$        |

# SKF – the knowledge engineering company

From the company that invented the self-aligning ball bearing more than 100 years ago, SKF has evolved into a knowledge engineering company that is able to draw on five technology platforms to create unique solutions for its customers. These platforms include bearings, bearing units and seals, of course, but extend to other areas including: lubricants and lubrication systems, critical for long bearing life in many applications; mechatronics that combine mechanical and electronics knowledge into systems for more effective linear motion and sensorized solutions; and a full range of services, from design and logistics support to conditioning monitoring and reliability systems.

Though the scope has broadened, SKF continues to maintain the world's leadership in the design, manufacture and marketing of rolling bearings, as well as complementary products such as radial seals. SKF also holds an increasingly important position in the market for linear motion products, high-precision aerospace bearings, machine tool spindles and plant maintenance services.

The SKF Group is globally certified to ISO 14001, the international standard for environmental management, as well as OHSAS 18001, the health and safety management standard. Individual divisions have been approved for quality certification in accordance with either ISO 9001 or other customer specific requirements.

With over 100 manufacturing sites worldwide and sales companies in 70 countries, SKF is a truly international corporation. In addition, our distributors and dealers in some 15 000 locations around the world, an e-business marketplace and a global distribution system put SKF close to customers for the supply of both products and services. In essence, SKF solutions are available wherever and whenever customers need them. Overall, the SKF brand and the corporation are stronger than ever. As the knowledge engineering company, we stand ready to serve you with world-class product competencies, intellectual resources, and the vision to help you succeed.

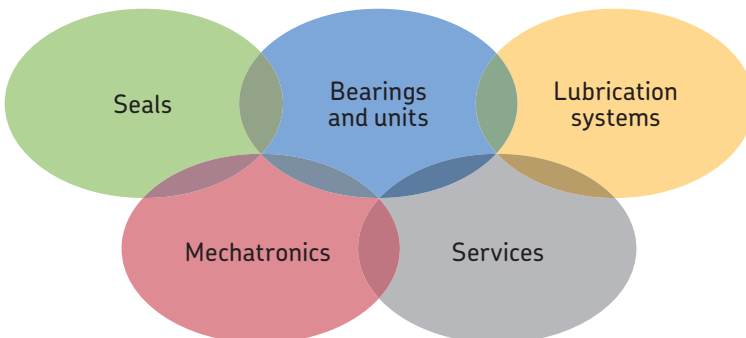



© Airbus – photo: e'm company, H. Goussé

### ***Evolving by-wire technology***

*SKF has a unique expertise in fast-growing by-wire technology, from fly-by-wire, to drive-by-wire, to work-by-wire. SKF pioneered practical fly-by-wire technology and is a close working partner with all aerospace industry leaders. As an example, virtually all aircraft of the Airbus design use SKF by-wire systems for cockpit flight control.*



*SKF is also a leader in automotive by-wire technology, and has partnered with automotive engineers to develop two concept cars, which employ SKF mechatronics for steering and braking. Further by-wire development has led SKF to produce an all-electric forklift truck, which uses mechatronics rather than hydraulics for all controls.*



### **Harnessing wind power**

*The growing industry of wind-generated electric power provides a source of clean, green electricity. SKF is working closely with global industry leaders to develop efficient and trouble-free turbines, providing a wide range of large, highly specialized bearings and condition monitoring systems to extend equipment life of wind farms located in even the most remote and inhospitable environments.*



### **Working in extreme environments**

*In frigid winters, especially in northern countries, extreme sub-zero temperatures can cause bearings in railway axleboxes to seize due to lubrication starvation. SKF created a new family of synthetic lubricants formulated to retain their lubrication viscosity even at these extreme temperatures. SKF knowledge enables manufacturers and end user customers to overcome the performance issues resulting from extreme temperatures, whether hot or cold. For example, SKF products are at work in diverse environments such as baking ovens and instant freezing in food processing plants*



### **Developing a cleaner cleaner**

*The electric motor and its bearings are the heart of many household appliances. SKF works closely with appliance manufacturers to improve their products' performance, cut costs, reduce weight, and reduce energy consumption. A recent example of this cooperation is a new generation of vacuum cleaners with substantially more suction. SKF knowledge in the area of small bearing technology is also applied to manufacturers of power tools and office equipment.*



### **Maintaining a 350 km/h R&D lab**

*In addition to SKF's renowned research and development facilities in Europe and the United States, Formula One car racing provides a unique environment for SKF to push the limits of bearing technology. For over 50 years, SKF products, engineering and knowledge have helped make Scuderia Ferrari a formidable force in F1 racing. (The average racing Ferrari utilizes more than 150 SKF components.) Lessons learned here are applied to the products we provide to automakers and the aftermarket worldwide.*



### **Delivering Asset Efficiency Optimization**

*Through SKF Reliability Systems, SKF provides a comprehensive range of asset efficiency products and services, from condition monitoring hardware and software to maintenance strategies, engineering assistance and machine reliability programmes. To optimize efficiency and boost productivity, some industrial facilities opt for an Integrated Maintenance Solution, in which SKF delivers all services under one fixed-fee, performance-based contract.*



### **Planning for sustainable growth**

*By their very nature, bearings make a positive contribution to the natural environment, enabling machinery to operate more efficiently, consume less power, and require less lubrication. By raising the performance bar for our own products, SKF is enabling a new generation of high-efficiency products and equipment. With an eye to the future and the world we will leave to our children, the SKF Group policy on environment, health and safety, as well as the manufacturing techniques, are planned and implemented to help protect and preserve the earth's limited natural resources. We remain committed to sustainable, environmentally responsible growth.*

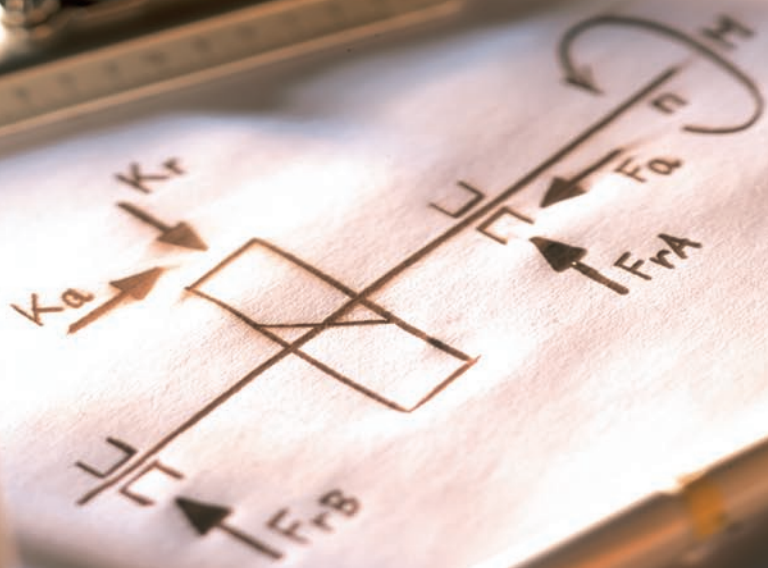

# Principles of bearing selection and application

|                                         |           |
|-----------------------------------------|-----------|
| <b>Bearing terminology</b> .....        | <b>14</b> |
| <b>Bearing types</b> .....              | <b>17</b> |
| Needle roller bearings.....             | 17        |
| Track runner bearings.....              | 27        |
| <b>Bearing life and loads</b> .....     | <b>32</b> |
| Bearing life.....                       | 32        |
| Equivalent bearing loads.....           | 32        |
| Static bearing loads.....               | 32        |
| Requisite minimum load .....            | 32        |
| <b>Friction</b> .....                   | <b>34</b> |
| Estimating the frictional moment.....   | 34        |
| <b>Speeds</b> .....                     | <b>35</b> |
| <b>Bearing data – general</b> .....     | <b>36</b> |
| Tolerances.....                         | 36        |
| Internal clearance.....                 | 42        |
| Cages.....                              | 43        |
| Seals.....                              | 43        |
| Materials.....                          | 43        |
| Supplementary designations.....         | 46        |
| <b>Application of bearings</b> .....    | <b>48</b> |
| Design of associated components .....   | 48        |
| Surface roughness of bearing seats..... | 50        |
| Raceways on shafts and in housings..... | 50        |
| <b>Lubrication</b> .....                | <b>52</b> |
| The SKF traffic light concept.....      | 52        |
| Lubricating greases.....                | 53        |

## Bearing terminology

To better understand frequently used needle roller and track runner bearing terms, definitions are provided in **fig. 1** to **6**.

### Drawn cup needle roller bearings (→ fig. 1)

- 1 Drawn cup
- 2 Lubrication hole
- 3 Closed end
- 4 Raceway
- 5 Needle roller and cage assembly
- 6 Open end

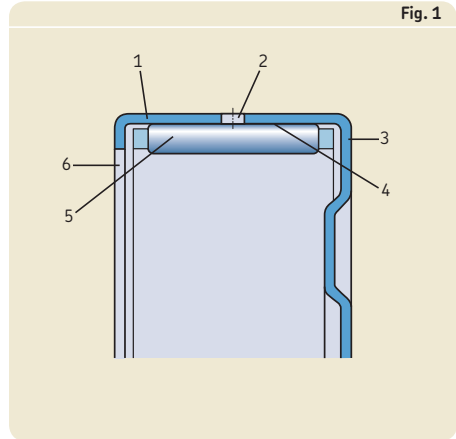

### Needle roller bearings with machined rings (→ fig. 2)

- 1 Outer ring
- 2 Lubrication hole
- 3 Annular groove
- 4 Raceway
- 5 Integral flange
- 6 Seal
- 7 Inner ring
- 8 Needle roller and cage assembly

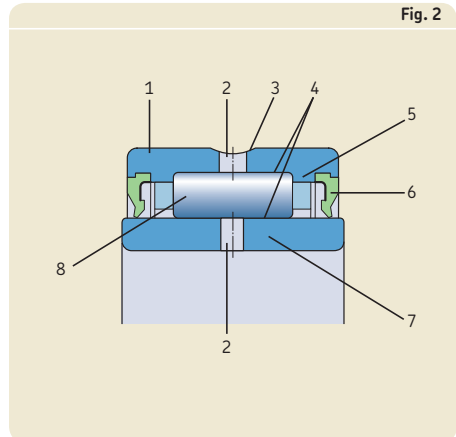

### Needle roller thrust bearings with a centring spigot (→ fig. 3)

- 1 Centring spigot
- 2 Needle roller and cage thrust assembly
- 3 Raceway

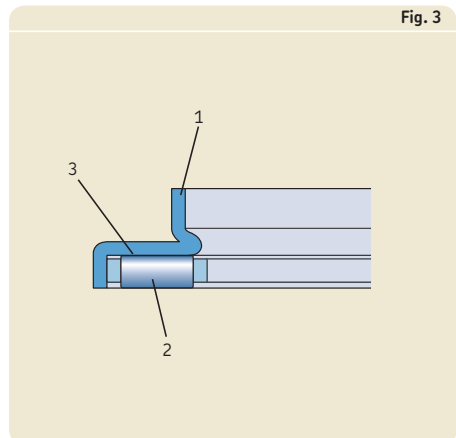
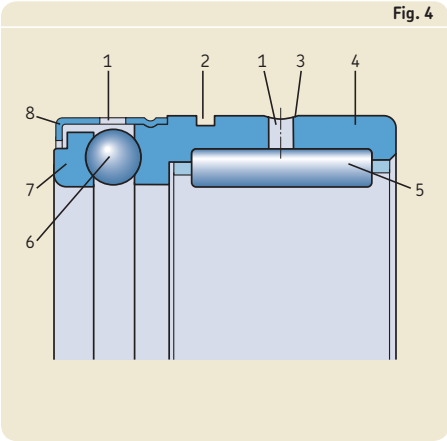



Fig. 4



**Needle roller / thrust ball bearings (→ fig. 4)**

- 1 Lubrication hole
- 2 Snap ring groove
- 3 Annular groove
- 4 Outer ring
- 5 Needle roller and cage assembly
- 6 Thrust rolling element: ball (full complement)
- 7 Shaft washer
- 8 Steel cover

Fig. 5

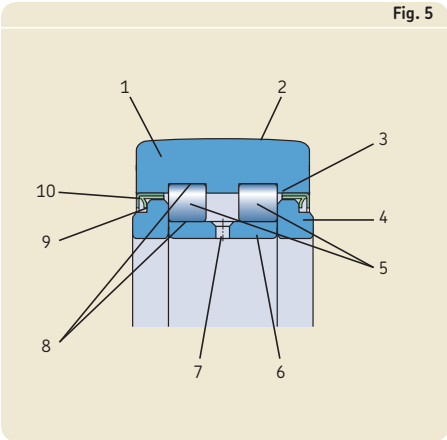

**Support rollers (→ fig. 5)**

- 1 Outer ring
- 2 Outer ring running surface
- 3 Integral flange
- 4 Loose flange ring
- 5 Rolling element: cylindrical roller (two rows full complement)
- 6 Inner ring
- 7 Lubrication hole
- 8 Raceway
- 9 Contact seal
- 10 Sheet metal angle ring

Fig. 6

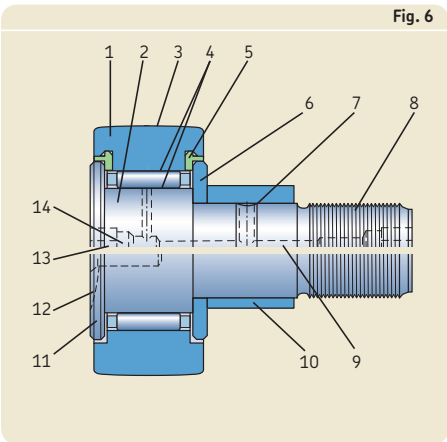

**Cam followers (→ fig. 6)**

- 1 Outer ring
- 2 Stud (pin)
- 3 Outer ring running surface
- 4 Raceway
- 5 Axial sliding ring
- 6 Pressed-on flange ring
- 7 Annular groove
- 8 Thread
- 9 Lubrication duct
- 10 Eccentric collar
- 11 Head/ integral flange
- 12 Slot
- 13 Recessed hexagon
- 14 Hole for grease fitting



# Bearing types

## Needle roller bearings

Needle roller bearings are bearings with cylindrical rollers that are small in diameter. In spite of their low cross section, needle roller bearings have a high load carrying capacity and are therefore extremely suitable for bearing arrangements where radial space is limited.

SKF supplies needle roller bearings in different designs and in a wide range of sizes, which are appropriate for different applications. In addition to customized designs, they comprise the following types and components:

- needle roller and cage assemblies
- drawn cup needle roller bearings
- universal joint bearings
- needle roller bearings with machined rings
- alignment needle roller bearings
- needle roller thrust bearings
- bearing washers
- combined needle roller bearings
- needle roller bearing inner rings
- needle rollers
- radial shaft seals with low cross sectional height

Basic information about the different needle roller bearing types, washers, and seals is provided in the following overview.

## Bearing types

### Needle roller and cage assemblies

See chapter 2 starting on **page 57**

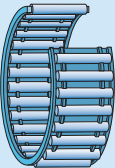
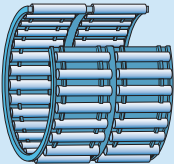
| Bearing design<br>Needle roller and cage assemblies                                                        | Designation series<br>Inside diameter range                                                   | Characteristics                     |
|------------------------------------------------------------------------------------------------------------|-----------------------------------------------------------------------------------------------|-------------------------------------|
| <b>Single row</b><br><br> | <b>K .. TN</b><br>$F_w = 3 - 45 \text{ mm}$<br><br><b>K</b><br>$F_w = 14 - 265 \text{ mm}$    | Polyamide 66 cage<br><br>Steel cage |
| <b>Double row</b><br><br> | <b>K .. ZWTN</b><br>$F_w = 32 \text{ mm}$<br><br><b>K .. ZW</b><br>$F_w = 24 - 95 \text{ mm}$ | Polyamide 66 cage<br><br>Steel cage |

### Drawn cup needle roller bearings

See chapter 3 starting on **page 75**

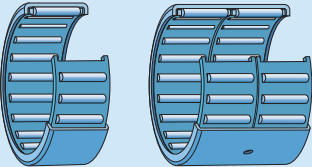
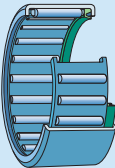
| Bearing design<br>Drawn cup needle roller bearings                                                                                              | Designation series<br>Inside diameter range                                           | Characteristics                                                                             |
|-------------------------------------------------------------------------------------------------------------------------------------------------|---------------------------------------------------------------------------------------|---------------------------------------------------------------------------------------------|
| <b>With open ends, HK series, not sealed</b><br><br>         | <b>HK .. TN</b><br>$F_w = 3 \text{ mm}$<br><br><b>HK</b><br>$F_w = 4 - 60 \text{ mm}$ | Polyamide 66 cage<br><br>Steel cage, size-dependent single or double row (→ product tables) |
| <b>With open ends, HK series, sealed on one side</b><br><br> | <b>HK .. RS</b><br>$F_w = 8 - 50 \text{ mm}$                                          | Steel cage, factory greased                                                                 |

**Bearing design**

Drawn cup needle roller bearings

**Designation series**

Inside diameter range

**Characteristics**

With open ends, HK series, sealed on both sides

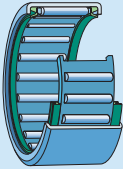

**HK ...2RS**  
 $F_w = 8 - 50$  mm

Steel cage, factory greased

With a closed end, BK series, not sealed

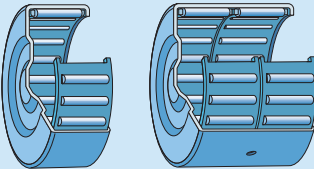

**BK .. TN**  
 $F_w = 3$  mm

Polyamide 66 cage

**BK**  
 $F_w = 4 - 45$  mm

Steel cage, size-dependent single or double row (→ product tables)

With a closed end, BK series, sealed

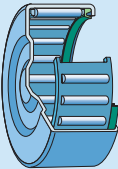

**BK .. RS**  
 $F_w = 10 - 25$  mm

Steel cage, factory greased

With open ends, HN series, full complement, not sealed

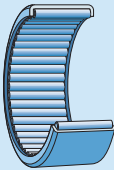

**HN**  
 $F_w = 10 - 50$  mm

Factory greased to secure the rollers

## Bearing types

### Universal joint bearings

Not covered in this catalogue.

For additional information, refer to the *SKF Interactive Engineering Catalogue*.

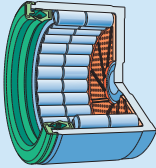
| Bearing design<br>Universal joint bearings                                        | Designation series | Characteristics                                                                                             |
|-----------------------------------------------------------------------------------|--------------------|-------------------------------------------------------------------------------------------------------------|
|  | BNKB               | Specific cold forged cup needle roller bearings for universal joints of commercial vehicle propeller shafts |

### Needle roller bearings with machined rings

See chapter 4 starting on **page 97**

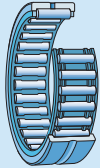
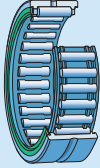
| Bearing design<br>Needle roller bearings with machined rings                        | Designation series<br>Inside diameter range                                                                                                                                                                                                                                                                                              | Characteristics                                                                                                                                                                                                                                                                                                                |
|-------------------------------------------------------------------------------------|------------------------------------------------------------------------------------------------------------------------------------------------------------------------------------------------------------------------------------------------------------------------------------------------------------------------------------------|--------------------------------------------------------------------------------------------------------------------------------------------------------------------------------------------------------------------------------------------------------------------------------------------------------------------------------|
| <b>With flanges, without an inner ring, not sealed</b>                              |                                                                                                                                                                                                                                                                                                                                          |                                                                                                                                                                                                                                                                                                                                |
|    | <p><b>NK .. TN</b><br/><math>F_w = 5 - 60</math> mm</p> <p><b>NK</b><br/><math>F_w = 12 - 110</math> mm</p> <p><b>NKS</b><br/><math>F_w = 20 - 75</math> mm</p> <p><b>RNA 49</b><br/><math>F_w = 14 - 160</math> mm</p> <p><b>RNA 69</b><br/><math>F_w = 16 - 110</math> mm</p> <p><b>RNA 48</b><br/><math>F_w = 120 - 415</math> mm</p> | <p>Integral flanges, annular groove and one or more lubrication holes (size dependent)</p> <p>If <math>F_w \leq 10</math> mm: with integral closure rings, without lubrication hole or annular groove</p> <p>RNA 69 series bearings with an outside diameter <math>D \geq 52</math> mm are designed as double row bearings</p> |
| <b>With flanges, without an inner ring, sealed on one side</b>                      |                                                                                                                                                                                                                                                                                                                                          |                                                                                                                                                                                                                                                                                                                                |
|  | <p><b>RNA 49.. RS</b><br/><math>F_w = 14 - 58</math> mm</p>                                                                                                                                                                                                                                                                              | <p>Integral flanges, annular groove and one or more lubrication holes (size dependent), factory greased</p>                                                                                                                                                                                                                    |

**Bearing design**  
Needle roller bearings with machined rings

**Designation series**  
Inside/bore diameter range

**Characteristics**

**With flanges, without an inner ring, sealed on both sides**

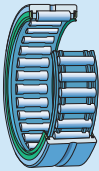

**RNA 49...2RS**  
 $F_w = 14 - 58$  mm

Integral flanges, annular groove and one or more lubrication holes (size dependent), factory greased

**With flanges, with an inner ring, not sealed**



**NKI .. TN**  
 $d = 5 - 55$  mm

**NKI**  
 $d = 9 - 100$  mm

**NKIS**  
 $d = 15 - 65$  mm

**NA 49**  
 $d = 10 - 140$  mm

**NA 69**  
 $d = 12 - 95$  mm

**NA 48**  
 $d = 110 - 380$  mm

Integral flanges, annular groove and one or more lubrication holes (size dependent)  
If  $d \leq 7$  mm: with integral closure rings, without lubrication hole or annular groove

NA 69 series bearings with an outside diameter  $D \geq 52$  mm are designed as double row bearings

**With flanges, with an inner ring, sealed on one side**

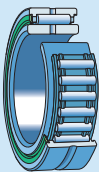

**NA 49.. RS**  
 $d = 10 - 50$  mm

Integral flanges, annular groove and one or more lubrication holes (size dependent), factory greased

**With flanges, with an inner ring, sealed on both sides**

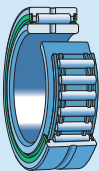

**NA 49...2RS**  
 $d = 10 - 50$  mm

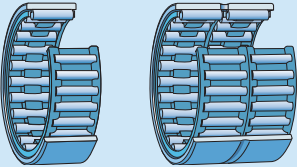
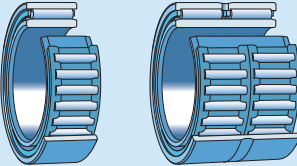

Integral flanges, annular groove and one or more lubrication holes (size dependent), factory greased

## Bearing types

| Bearing design<br>Needle roller bearings with machined rings                      | Designation series<br>Inside/bore diameter range                                                          | Characteristics                                                                                                                                                                                                           |
|-----------------------------------------------------------------------------------|-----------------------------------------------------------------------------------------------------------|---------------------------------------------------------------------------------------------------------------------------------------------------------------------------------------------------------------------------|
| <b>Without flanges, without an inner ring, not sealed</b>                         |                                                                                                           |                                                                                                                                                                                                                           |
|  | <p><b>RNAO .. TN</b><br/>F<sub>w</sub> = 5 – 12 mm</p> <p><b>RNAO</b><br/>F<sub>w</sub> = 15 – 100 mm</p> | <p>Available as single or double row bearings (→ product tables)<br/>Double row bearings have an annular groove and a lubrication hole</p>                                                                                |
| <b>Without flanges, with an inner ring, not sealed</b>                            |                                                                                                           |                                                                                                                                                                                                                           |
|  | <p><b>NAO .. TN</b><br/>d = 6 – 9 mm</p> <p><b>NAO</b><br/>d = 12 – 90 mm</p>                             | <p>Available as single or double row bearings (→ product table)<br/>Double row bearings have an annular groove and a lubrication hole<br/>Some bearings have one lubrication hole in the inner ring (→ product table)</p> |

## Alignment needle roller bearings

See chapter 5 starting on **page 141**

| Bearing design<br>Alignment needle roller bearings                                  | Designation series<br>Inside/bore diameter range  | Characteristics                                                                                                                   |
|-------------------------------------------------------------------------------------|---------------------------------------------------|-----------------------------------------------------------------------------------------------------------------------------------|
| <b>Without an inner ring</b>                                                        |                                                   |                                                                                                                                   |
|  | <p><b>RPNA</b><br/>F<sub>w</sub> = 15 – 45 mm</p> | <p>Can compensate static misalignment up to 3° between the shaft and housing<br/>Steel cage, not sealed, no lubrication holes</p> |
| <b>With an inner ring</b>                                                           |                                                   |                                                                                                                                   |
|  | <p><b>PNA</b><br/>d = 12 - 40 mm</p>              | <p>Can compensate static misalignment up to 3° between the shaft and housing<br/>Steel cage, not sealed, no lubrication holes</p> |



## Needle roller thrust bearings

See chapter 6 starting on **page 151**

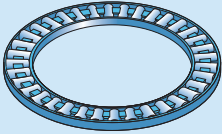
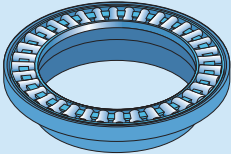
| Bearing design<br>Needle roller thrust bearings                                                                                                      | Designation series<br>Bore diameter range                                      | Characteristics                                                                                          |
|------------------------------------------------------------------------------------------------------------------------------------------------------|--------------------------------------------------------------------------------|----------------------------------------------------------------------------------------------------------|
| <p><b>Needle roller and cage thrust assemblies</b></p>              | <p><b>AXK .. TN</b><br/>d = 4 – 8 mm</p> <p><b>AXK</b><br/>d = 10 – 160 mm</p> | <p>Appropriate washers: LS, AS, GS 811 and WS 811 series</p>                                             |
| <p><b>Needle roller thrust bearings with a centring spigot</b></p>  | <p><b>AXW</b><br/>d = 10 – 50 mm</p>                                           | <p>Can be combined with radial needle roller bearings to accommodate combined radial and axial loads</p> |

## Bearing washers

See chapter 6 on **page 154**

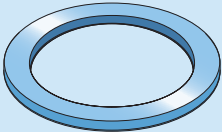
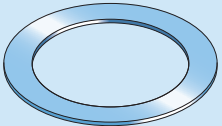
| Bearing design<br>Bearing washers                                                                                            | Designation series<br>Bore diameter range | Characteristics                                                                                                                             |
|------------------------------------------------------------------------------------------------------------------------------|-------------------------------------------|---------------------------------------------------------------------------------------------------------------------------------------------|
| <p><b>Raceway washers, LS series</b></p>  | <p><b>LS</b><br/>d = 6 – 160 mm</p>       | <p>Ground raceway, turned bore and outside diameter, can be combined with AXK and AXW series</p>                                            |
| <p><b>Thrust washers, AS series</b></p>   | <p><b>AS</b><br/>d = 4 – 160 mm</p>       | <p>Made of spring steel, 1 mm thick, hardened and polished, can be combined with AXK and AXW series, both sides can be used as raceways</p> |

## Bearing types

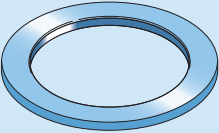
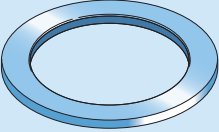
| Bearing design<br>Bearing washers                                                                                       | Designation series<br>Bore/outside diameter range | Characteristics                                                                                                          |
|-------------------------------------------------------------------------------------------------------------------------|---------------------------------------------------|--------------------------------------------------------------------------------------------------------------------------|
| Shaft washers, WS 811 series<br><br>   | <b>WS 811</b><br>d = 15 – 630 mm                  | Precision machined raceway, ground bore, can be combined with AXK and AXW series, for bore diameters up to 160 mm        |
| Housing washers, GS 811 series<br><br> | <b>GS 811</b><br>D = 28 – 750 mm                  | Precision machined raceway, ground outside diameter, can be combined with AXK series, for outside diameters up to 200 mm |

## Combined needle roller bearings

See chapter 7 starting on **page 169**

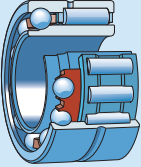
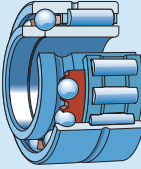
| Bearing design<br>Combined needle roller bearings                                                                                                     | Designation series<br>Bore diameter range | Characteristics                                |
|-------------------------------------------------------------------------------------------------------------------------------------------------------|-------------------------------------------|------------------------------------------------|
| Needle roller / angular contact ball bearings, NKIA series<br><br> | <b>NKIA</b><br>d = 12 – 70 mm             | Can accommodate axial loads in one direction   |
| Needle roller / angular contact ball bearings, NKIB series<br><br> | <b>NKIB</b><br>d = 12 – 70 mm             | Can accommodate axial loads in both directions |

**Bearing design**  
Combined needle roller bearings

**Designation series**  
Inside diameter range

**Characteristics**

**Needle roller / thrust ball bearings, NX series**

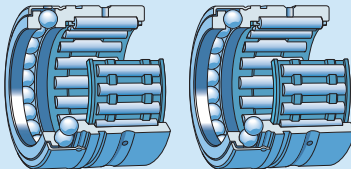

NX series

NX..Z series

**NX .. (Z)TN**  
 $F_w = 7 \text{ mm}$

**NX .. (Z)**  
 $F_w = 10 - 35 \text{ mm}$

Full complement thrust ball bearing, steel cover with or without lubrication holes  
NX .. Z series: factory greased thrust bearing, steel cover without lubrication hole

**Needle roller / thrust ball bearings, NKX series**

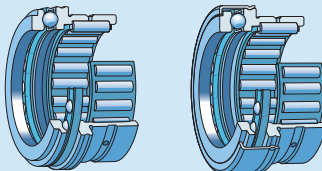

NKX series

NKX..Z series

**NKX .. (Z)TN**  
 $F_w = 10 \text{ mm}$

**NKX .. (Z)**  
 $F_w = 12 - 70 \text{ mm}$

Thrust ball bearing with a cage, with or without steel cover  
NKX .. Z series: factory greased thrust bearing, steel cover without lubrication hole

**Needle roller / cylindrical roller thrust bearings, NKXR series**

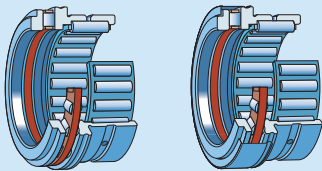

NKXR series

NKXR..Z series

**NKXR**  
 $F_w = 15 - 50 \text{ mm}$

**NKXR .. Z**  
 $F_w = 15 - 50 \text{ mm}$

Separable bearing design

Thrust bearing with a steel cover and initial grease fill, non-separable bearing design

## Bearing types

### Needle roller bearing inner rings

See chapter 8 starting on **page 195**

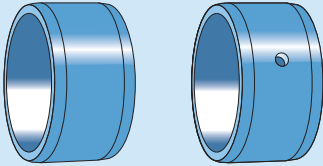
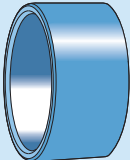
| Bearing design<br>Needle roller bearing inner rings                                                                                                                               | Designation series<br>Bore diameter range                                                                                                                                                           | Characteristics                                                                                                                                                                          |
|-----------------------------------------------------------------------------------------------------------------------------------------------------------------------------------|-----------------------------------------------------------------------------------------------------------------------------------------------------------------------------------------------------|------------------------------------------------------------------------------------------------------------------------------------------------------------------------------------------|
|  <p data-bbox="157 480 219 496">IR series</p> <p data-bbox="344 480 445 496">IR.. IS1 series</p> | <p data-bbox="575 304 591 320"><b>IR</b></p> <p data-bbox="575 323 687 339">d = 5 – 380 mm</p> <p data-bbox="575 357 636 373"><b>IR .. IS1</b></p> <p data-bbox="575 376 678 392">d = 6 – 50 mm</p> | <p data-bbox="815 304 997 427">Made of carbon chromium bearing steel, hardened, precision machined raceway with a lead-in chamfer on both sides, with or without lubrication hole(s)</p> |
|  <p data-bbox="157 727 219 743">LR series</p>                                                    | <p data-bbox="575 555 598 571"><b>LR</b></p> <p data-bbox="575 572 678 592">d = 7 – 50 mm</p>                                                                                                       | <p data-bbox="815 555 997 624">Made of carbon chromium bearing steel, hardened, ground bore and raceway, turned side faces</p>                                                           |

### Radial shaft seals with a low cross sectional height

See chapter 8 on **page 208**

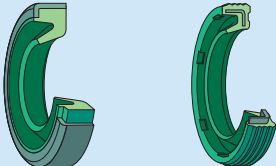
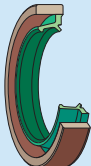
| Bearing design<br>Radial shaft seals with a low cross sectional height                                                                                                               | Designation series<br>Bore diameter range                                                                                                                                                                                     | Characteristics                                                                                                                                                                                                             |
|--------------------------------------------------------------------------------------------------------------------------------------------------------------------------------------|-------------------------------------------------------------------------------------------------------------------------------------------------------------------------------------------------------------------------------|-----------------------------------------------------------------------------------------------------------------------------------------------------------------------------------------------------------------------------|
|  <p data-bbox="157 1206 241 1222">G .. S series</p> <p data-bbox="344 1206 400 1222">G series</p> | <p data-bbox="575 1098 620 1114"><b>G .. S</b></p> <p data-bbox="575 1117 678 1133">d<sub>1</sub> = 4 – 7 mm</p> <p data-bbox="575 1150 586 1166"><b>G</b></p> <p data-bbox="575 1169 687 1185">d<sub>1</sub> = 8 – 70 mm</p> | <p data-bbox="815 1031 997 1082">Single lip design, made of acrylonitrile-butadiene rubber</p> <p data-bbox="815 1099 975 1134">Rubber material metal cased</p> <p data-bbox="815 1152 969 1168">Sheet steel reinforced</p> |
|  <p data-bbox="157 1460 230 1476">SD design</p>                                                   | <p data-bbox="575 1281 598 1297"><b>SD</b></p> <p data-bbox="575 1300 687 1318">d<sub>1</sub> = 8 – 50 mm</p>                                                                                                                 | <p data-bbox="815 1281 997 1350">Double lip design, lips are made of polyurethane elastomer, polyamide reinforcement ring</p>                                                                                               |

# Track runner bearings

SKF track runner bearings are rolling bearings with a very thick-walled outer ring that can accommodate heavy loads as well as shock loads. The designs of track runner bearings are based on ball bearings, needle roller bearings as well as cylindrical roller bearings.

SKF supplies track runner bearings in many different designs and for a wide variety of operating conditions and applications. They are ready-to-mount pre-greased units and are intended for all types of cam drives, tracks, conveyor systems, etc. The rails used for SKF linear guides can serve as tracks for the bearings.



Basics of the SKF track runner bearing assortment are listed below and comprises the following types:

- cam rollers
- support rollers
- cam followers

## Cam rollers

Not covered in this catalogue.

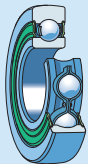

For additional information, refer to the *SKF Interactive Engineering Catalogue*.

| Bearing design<br>Cam rollers                                                                                                  | Designation series<br>Outside diameter range | Characteristics                   |
|--------------------------------------------------------------------------------------------------------------------------------|----------------------------------------------|-----------------------------------|
| <b>Single row</b><br>                       | <b>3612.. R</b><br>D = 32 – 80 mm            | Sealed, crowned running surface   |
| <b>Double row</b><br><br>3058.. C-2Z series | <b>3058.. C-2Z</b><br>D = 32 – 80 mm         | Sealed<br>Crowned running surface |
| <br>3057.. C-2Z series                      | <b>3057.. C-2Z</b><br>D = 35 – 80 mm         | Cylindrical running surface       |

## Bearing types

### Support rollers

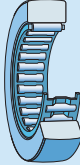
See chapter 9 starting on **page 215**

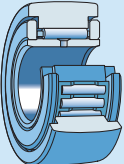
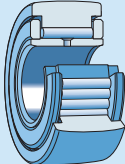
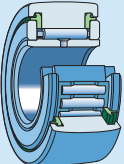
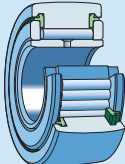
| Bearing design                                                                                                | Designation series                                                  | Characteristics                  |
|---------------------------------------------------------------------------------------------------------------|---------------------------------------------------------------------|----------------------------------|
| <b>Without flange rings, (R)STO and (R)NA 22...2RS designs</b>                                                |                                                                     |                                  |
|  <p>STO design</p>           | <p><b>STO .. TN</b><br/>D = 19 – 24 mm</p>                          | Crowned running surface          |
|  <p>RSTO design</p>          | <p><b>STO</b><br/>D = 30 – 90 mm</p>                                |                                  |
|  <p>NA 22...2RS design</p>   | <p><b>RSTO .. TN</b><br/>D = 16 – 24 mm</p>                         |                                  |
|  <p>RNA 22...2RS design</p>  | <p><b>RSTO</b><br/>D = 30 – 90 mm</p>                               |                                  |
|                                                                                                               | <p><b>NA 22...2RS</b><br/>D = 19 – 90 mm</p>                        |                                  |
|                                                                                                               | <p><b>RNA 22...2RS</b><br/>D = 19 – 80 mm</p>                       |                                  |
| <b>With flange rings, NATR and NATV designs</b>                                                               |                                                                     |                                  |
|  <p>NATR design</p>         | <p><b>NATR</b><br/><b>NATV</b><br/>D = 16 – 62 mm</p>               | Crowned running surface          |
|  <p>NATV design</p>         |                                                                     |                                  |
|  <p>NATR .. PPA series</p> | <p><b>NATR .. PPA</b><br/><b>NATV .. PPA</b><br/>D = 16 – 90 mm</p> | Improved crowned running surface |
|  <p>NATV .. PPA series</p> |                                                                     |                                  |

**Bearing design**  
Support rollers

**Designation series**  
Outside diameter range

**Characteristics**

With flange rings, NUTR ..A design

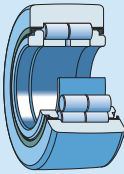

**NUTR .. A**  
D = 35 – 110 mm

Can accommodate axial forces and heavy shock loads, improved crowned running surface

With flange rings, PWTR ...2RS design

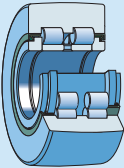

**PWTR ...2RS**  
D = 35 – 110 mm

Improved crowned running surface

With flange rings, NNTR ...2ZL design

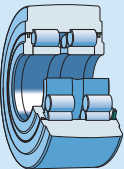

**NNTR ...2ZL**  
D = 130 – 310 mm

Size-dependent crowned running surface

## Bearing types

### Cam followers

See chapter 9 on page 238

| Bearing design<br>Cam followers | Designation series<br>Outside diameter range                                 | Characteristics                                                                                                                                                                                                                                                                                                              |
|---------------------------------|------------------------------------------------------------------------------|------------------------------------------------------------------------------------------------------------------------------------------------------------------------------------------------------------------------------------------------------------------------------------------------------------------------------|
| <b>KR design</b>                |                                                                              |                                                                                                                                                                                                                                                                                                                              |
|                                 | <b>KR .. B</b><br>D = 22 – 40 mm                                             | Crowned outer ring running surface as standard, designation suffixes PPSKA and PPA with an improved crowned profile, with or without axial sliding rings, cage-guided or full complement of needle rollers, concentric or eccentric seat, size-dependent characteristics regarding relubrication and holding during mounting |
| KR .. B series                  | <b>KR .. (PPSKA)</b><br>D = 16 – 19 mm                                       |                                                                                                                                                                                                                                                                                                                              |
|                                 | <b>KR .. PPA</b><br><b>KRV .. PPA</b><br><b>KRE .. PPA</b><br>D = 16 – 90 mm |                                                                                                                                                                                                                                                                                                                              |
| KR .. PPSKA series              |                                                                              |                                                                                                                                                                                                                                                                                                                              |
|                                 |                                                                              |                                                                                                                                                                                                                                                                                                                              |
| KRV .. PPA series               |                                                                              |                                                                                                                                                                                                                                                                                                                              |
|                                 |                                                                              |                                                                                                                                                                                                                                                                                                                              |
| KRE .. PPA series               |                                                                              |                                                                                                                                                                                                                                                                                                                              |



**Bearing design**  
Cam followers

**Designation series**  
Outside diameter range

**Characteristics**

**NUKR design**

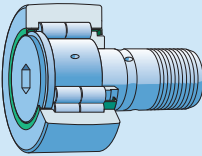

NUKR .. A design

**NUKR .. A**  
**NUKRE .. A**  
D = 35 – 90 mm

Improved crowned profile of the outer ring running surface, concentric seat or eccentric collar on the stud

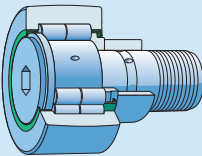

NUKRE .. A design

**PWKR design**

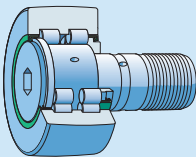

PWKR ...2RS design

**PWKR ...2RS**  
**PWKRE ...2RS**  
D = 35 – 90 mm

Improved crowned profile of the outer ring running surface, concentric seat or eccentric collar on the stud

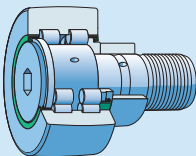

PWKRE ...2RS design

# Bearing life and loads

## Bearing life

The bearing size to be used can be selected on the basis of its load ratings in relation to the applied loads and the requirements regarding bearing life and reliability. A simple way to calculate bearing life is the classic ISO formula for basic rating life. However, SKF recommends using the SKF rating life, which makes predicting bearing life more reliable.

The values of the basic dynamic load rating  $C$  and the basic static load rating  $C_0$  are listed in the product tables.

For additional information about the calculation methods and the equations, refer to the *SKF General Catalogue*. Calculations can also be performed easily online using the *SKF Interactive Engineering Catalogue*, available online at [www.skf.com](http://www.skf.com).

The general information about bearing life calculations and basic load ratings provided in the *SKF General Catalogue* and in the *SKF Interactive Engineering Catalogue* are also valid for needle roller bearings.

## Equivalent bearing loads

Needle roller bearings can accommodate either radial loads (radial bearings) or axial loads (thrust bearings). Therefore, the equivalent bearing load  $P$  is equal to the calculated bearing load  $F$  and can be inserted directly into the life equations.

### Combined needle roller bearings

The equation  $P = F$  is also valid for the radial and thrust bearing of combined needle roller bearings. It is necessary to calculate the life of the

radial needle roller bearing and the thrust bearing separately.

For needle roller / angular contact ball bearings, the axial component of the load  $F_a$  must not exceed 25% of the radial component of the load  $F_r$ .

The values of the basic load ratings  $C$  for the radial and axial bearings are listed separately in the product tables.

## Static bearing loads

The basic static load rating  $C_0$  is used in calculations when the bearings are to:

- rotate at very slow speeds ( $n < 10$  r/min)
- perform very slow oscillating movements
- be stationary under load for extended periods
- be under shock or heavy peak loads, whether it is rotating (dynamically stressed) or at rest

If one of these conditions exists, refer to the *SKF General Catalogue* (section *Selection of bearing size*).

## Requisite minimum load

The correlation between load and service life is less important when bearings are subjected to very light loads, because the failure mode is typically something other than fatigue.

To achieve satisfactory operation, needle roller and track runner bearings must always be subjected to a requisite minimum load. Applying a requisite minimum load is especially important for bearings that operate at high speeds or are subjected to high accelerations or rapid changes in the direction of load. Under these conditions, not applying the correct minimum load can

result in damaging sliding movement between the rollers and raceways caused by the inertia forces of the needle rollers and cage and friction in the lubricant.

The requisite minimum radial and axial loads to be applied can be estimated for:

- radial needle roller bearings using

$$F_{rm} = 0,02 C$$

- needle roller thrust bearings using

$$F_{am} = 0,0005 C_0$$

- track runner bearings using

$$F_{rm} = 0,0167 C_0$$

The requisite minimum axial load for the thrust part of combined bearings can be obtained for:

- angular contact ball bearings using

$$F_{am} = 0,25 \frac{C_0}{1\,000} \left( \frac{n d_m}{100\,000} \right)^2$$

- cylindrical roller thrust bearings using

$$F_{am} = 0,0005 C_0 + A \left( \frac{n}{1\,000} \right)^2$$

- thrust ball bearings using

$$F_{am} = A \left( \frac{n}{1\,000} \right)^2$$

where

$F_{rm}$  = minimum radial load [kN]

$F_{am}$  = minimum axial load [kN]

$C$  = basic dynamic load rating  
(→ product tables) [kN]

$C_0$  = basic static load rating  
(→ product tables) [kN]

$d_m$  = mean bearing diameter  
=  $0,5 (d + D)$  [mm]

$n$  = rotational speed [r/min]

$A$  = minimum load factor (→ product tables)

When starting up at low temperatures or when the lubricant is highly viscous, an even greater minimum load may be required. However, the weight of the components supported by the bearing, together with the external forces, generally exceeds the requisite minimum load. If this is not the case, the bearing must be subjected to an additional radial and/or axial load.

# Friction

Friction in a bearing can be described as the resistance to rotation. The friction dictates the amount of heat generated within a bearing and consequently determines the bearing operating temperature. The amount of friction within a bearing depends on the load and several other factors including bearing type, size, operating speed, and the properties and quantity of the lubricant.

Friction in a bearing is produced in the contact areas. These are the areas where the rolling elements make contact with the raceways, cage(s), guiding surfaces and lubricant. If the bearing is sealed, the contact area also includes the area where the sealing lip makes contact with its counterface.

## Estimating the frictional moment

The frictional moment can be calculated with sufficient accuracy under the following conditions:

- bearing load  $P \approx 0,1 C$
- good lubrication
- normal operating conditions

When using a coefficient of friction, the equations to be used are the following:

for radial needle roller bearings

$$M = 0,5 \mu P F_w$$

and for other bearing types

$$M = 0,5 \mu P d$$

Table 1

**Coefficient of friction  $\mu$  for bearings without seals, with a cage**

| Bearing type                            | Coefficient |
|-----------------------------------------|-------------|
| Radial needle roller bearings           | 0,0022      |
| Needle roller thrust bearings           | 0,0050      |
| <b>Thrust part of combined bearings</b> |             |
| Angular contact ball bearings           | 0,0020      |
| Thrust ball bearings                    | 0,0013      |
| Cylindrical roller thrust bearings      | 0,0050      |

where

$M$  = frictional moment [Nmm]

$\mu$  = coefficient of friction ( $\rightarrow$  table 1)

$P$  = equivalent dynamic bearing load [N]

$F_w$  = diameter under rollers [mm]

For needle roller bearings with an inner ring, the inner ring raceway diameter  $F$  is to be used.

$d$  = bearing bore diameter [mm]

For additional information about calculating the frictional moment of needle roller bearings, refer to the SKF *General Catalogue*. Calculations can be easily performed online using the *SKF Interactive Engineering Catalogue*, available online at [www.skf.com](http://www.skf.com).

For information about calculating the frictional moment of track runner bearings, contact the SKF application engineering service.

# Speeds

In the product tables, two speeds are typically listed: reference speed and limiting speed.

The reference speed represents the speed, under specific operating conditions, at which there is equilibrium between the heat that is generated by the bearing and the heat that is dissipated from the bearing via the shaft, housing and lubricant.

Limiting speed is determined by criteria that include the form stability or strength of the cage, lubrication of cage guiding surfaces, centrifugal and gyratory forces acting on the rolling elements, precision and other speed-limiting factors such as seals and lubricant for sealed bearings.

Which of these two speed values to consider depends on the needs of the application. In certain applications, such as very low speeds or oscillating movements, the speed limits are superseded in importance by other considerations.

For certain bearings, where the speed limit is not determined by heat from the rolling elements/raceway contacts, only limiting speeds are listed in the product tables. These include, for example, bearings with contact seals and all track runner bearings.

For additional information about speeds and calculations, refer to the SKF *General Catalogue* (section *Speeds and vibration*).

# Bearing data – general

SKF needle roller bearings are manufactured to several specifications. These specifications, concerning tolerances and internal clearance, are described in the following sections. Information about each bearing type is provided in the introductory text of the individual product chapters.

## Tolerances

Unless otherwise stated, the needle roller bearings listed in this catalogue are manufactured to dimensional, form and running accuracy of needle roller bearings in accordance with the following international standards:

- ISO 199:2005: Rolling bearings – Thrust bearings – Tolerances
- ISO 492:2002: Rolling bearings – Radial bearings – Tolerances

Information about the bearing types and the relevant tolerance classes are provided in the introductory text of the individual product chapters as well as tolerances for the inside diameter  $F_w$  of the roller set. Actual tolerance values are listed in **tables 2 to 5** on **pages 38 to 41**. The tolerance symbols used there are listed together with their definitions in **table 1**.

Table 1

1

## Tolerance symbols

## Symbol      Definition

**Bore diameter**

|                        |                                                                                                         |
|------------------------|---------------------------------------------------------------------------------------------------------|
| <b>d</b>               | Nominal bore diameter                                                                                   |
| <b>d<sub>mp</sub></b>  | Mean bore diameter, arithmetical mean of the largest and smallest single bore diameters in one plane    |
| <b>Δ<sub>dmp</sub></b> | Deviation of the mean bore diameter from the nominal ( $\Delta_{dmp} = d_{mp} - d$ )                    |
| <b>V<sub>dp</sub></b>  | Bore diameter variation; difference between the largest and smallest single bore diameters in one plane |
| <b>V<sub>dmp</sub></b> | Mean bore diameter variation; difference between the largest and smallest mean bore diameter            |

**Outside diameter**

|                        |                                                                                                                           |
|------------------------|---------------------------------------------------------------------------------------------------------------------------|
| <b>D</b>               | Nominal outside diameter                                                                                                  |
| <b>D<sub>mp</sub></b>  | Mean outside diameter; arithmetical mean of the largest and smallest single outside diameters in one plane                |
| <b>Δ<sub>Dmp</sub></b> | Deviation of the mean outside diameter from the nominal ( $\Delta_{Dmp} = D_{mp} - D$ )                                   |
| <b>V<sub>Dp</sub></b>  | Outside diameter variation; difference between the largest and smallest single outside diameters in one plane             |
| <b>V<sub>Dmp</sub></b> | Mean outside diameter variation; difference between the largest and smallest mean outside diameters of one ring or washer |

**Width or height**

|                                       |                                                                                                                                            |
|---------------------------------------|--------------------------------------------------------------------------------------------------------------------------------------------|
| <b>B<sub>s</sub>, C<sub>s</sub></b>   | Single width of the inner ring and outer ring, respectively                                                                                |
| <b>Δ<sub>Bs</sub>, Δ<sub>Cs</sub></b> | Deviation of the single inner ring width or single outer ring width from the nominal ( $\Delta_{Bs} = B_s - B$ ; $\Delta_{Cs} = C_s - C$ ) |
| <b>V<sub>Bs</sub>, V<sub>Cs</sub></b> | Ring width variation; difference between the largest and smallest single widths of the inner ring and of the outer ring, respectively      |
| <b>T<sub>S</sub></b>                  | Single height (H) of a single direction thrust bearing                                                                                     |
| <b>Δ<sub>Ts</sub></b>                 | Deviation of the single height of a thrust bearing from the nominal ( $\Delta_{Ts} = T_S - T$ )                                            |

**Running accuracy**

|                                       |                                                                                                                                                                 |
|---------------------------------------|-----------------------------------------------------------------------------------------------------------------------------------------------------------------|
| <b>K<sub>ia</sub>, K<sub>ea</sub></b> | Radial runout of the inner ring and outer ring, respectively, of an assembled bearing                                                                           |
| <b>S<sub>d</sub></b>                  | Side face runout with reference to the bore (of an inner ring)                                                                                                  |
| <b>S<sub>D</sub></b>                  | Outside inclination variation; variation in inclination of an outside cylindrical surface to an outer ring side face                                            |
| <b>S<sub>i</sub>, S<sub>e</sub></b>   | Thickness variation, measured from the middle of the raceway to the back (seat) face of the shaft washer and of the housing washer, respectively (axial runout) |

Table 2

Normal tolerances for radial needle roller bearings and track runner bearings

Inner ring

| d <sup>1)</sup><br>over | incl.      | $\Delta_{dmp}$ |     | $V_{dp}$<br>max | $V_{dmp}$<br>max | $\Delta_{Bs}$ |      | $V_{Bs}$<br>max | $K_{ia}$<br>max |
|-------------------------|------------|----------------|-----|-----------------|------------------|---------------|------|-----------------|-----------------|
|                         |            | high           | low |                 |                  | high          | low  |                 |                 |
| mm                      |            | $\mu m$        |     | $\mu m$         | $\mu m$          | $\mu m$       |      | $\mu m$         | $\mu m$         |
| <b>2,5</b>              | <b>10</b>  | 0              | -8  | 10              | 6                | 0             | -120 | 15              | 10              |
| <b>10</b>               | <b>18</b>  | 0              | -8  | 10              | 6                | 0             | -120 | 20              | 10              |
| <b>18</b>               | <b>30</b>  | 0              | -10 | 13              | 8                | 0             | -120 | 20              | 13              |
| <b>30</b>               | <b>50</b>  | 0              | -12 | 15              | 9                | 0             | -120 | 20              | 15              |
| <b>50</b>               | <b>80</b>  | 0              | -15 | 19              | 11               | 0             | -150 | 25              | 20              |
| <b>80</b>               | <b>120</b> | 0              | -20 | 25              | 15               | 0             | -200 | 25              | 25              |
| <b>120</b>              | <b>180</b> | 0              | -25 | 31              | 19               | 0             | -250 | 30              | 30              |
| <b>180</b>              | <b>250</b> | 0              | -30 | 38              | 23               | 0             | -300 | 30              | 40              |
| <b>250</b>              | <b>315</b> | 0              | -35 | 44              | 26               | 0             | -350 | 35              | 50              |
| <b>315</b>              | <b>400</b> | 0              | -40 | 50              | 30               | 0             | -400 | 40              | 60              |

<sup>1)</sup> For cam followers the stud shank diameter d can be used as the bore diameter reference.

Outer ring

| D<br>over  | incl.      | $\Delta_{Dmp}$ |     | $V_{Dp}$<br>max | $V_{Dmp}$<br>max | $\Delta_{Cs}, V_{Cs}$                                                                  | $K_{ea}$<br>max |
|------------|------------|----------------|-----|-----------------|------------------|----------------------------------------------------------------------------------------|-----------------|
|            |            | high           | low |                 |                  |                                                                                        |                 |
| mm         |            | $\mu m$        |     | $\mu m$         | $\mu m$          |                                                                                        | $\mu m$         |
| <b>6</b>   | <b>18</b>  | 0              | -8  | 10              | 6                | Values are identical to those for inner ring of same bearing ( $\Delta_{Bs}, V_{Bs}$ ) | 15              |
| <b>18</b>  | <b>30</b>  | 0              | -9  | 12              | 7                |                                                                                        | 15              |
| <b>30</b>  | <b>50</b>  | 0              | -11 | 14              | 8                |                                                                                        | 20              |
| <b>50</b>  | <b>80</b>  | 0              | -13 | 16              | 10               |                                                                                        | 25              |
| <b>80</b>  | <b>120</b> | 0              | -15 | 19              | 11               |                                                                                        | 35              |
| <b>120</b> | <b>150</b> | 0              | -18 | 23              | 14               |                                                                                        | 40              |
| <b>150</b> | <b>180</b> | 0              | -25 | 31              | 19               |                                                                                        | 45              |
| <b>180</b> | <b>250</b> | 0              | -30 | 38              | 23               |                                                                                        | 50              |
| <b>250</b> | <b>315</b> | 0              | -35 | 44              | 26               |                                                                                        | 60              |
| <b>315</b> | <b>400</b> | 0              | -40 | 50              | 30               |                                                                                        | 70              |
| <b>400</b> | <b>500</b> | 0              | -45 | 56              | 34               |                                                                                        | 80              |



Table 3

1

## Class P6 tolerances for radial bearings

## Inner ring

| d<br>over  | incl.      | $\Delta_{dmp}$<br>high | low | $V_{dp}$<br>max | $V_{dmp}$<br>max | $\Delta_{Bs}$<br>high | low  | $V_{Bs}$<br>max | $K_{ia}$<br>max |
|------------|------------|------------------------|-----|-----------------|------------------|-----------------------|------|-----------------|-----------------|
| mm         |            | $\mu\text{m}$          |     | $\mu\text{m}$   | $\mu\text{m}$    | $\mu\text{m}$         |      | $\mu\text{m}$   | $\mu\text{m}$   |
| <b>2,5</b> | <b>10</b>  | 0                      | -7  | 9               | 5                | 0                     | -120 | 15              | 6               |
| <b>10</b>  | <b>18</b>  | 0                      | -7  | 9               | 5                | 0                     | -120 | 20              | 7               |
| <b>18</b>  | <b>30</b>  | 0                      | -8  | 10              | 6                | 0                     | -120 | 20              | 8               |
| <b>30</b>  | <b>50</b>  | 0                      | -10 | 13              | 8                | 0                     | -120 | 20              | 10              |
| <b>50</b>  | <b>80</b>  | 0                      | -12 | 15              | 9                | 0                     | -150 | 25              | 10              |
| <b>80</b>  | <b>120</b> | 0                      | -15 | 19              | 11               | 0                     | -200 | 25              | 13              |
| <b>120</b> | <b>180</b> | 0                      | -18 | 23              | 14               | 0                     | -250 | 30              | 18              |
| <b>180</b> | <b>250</b> | 0                      | -22 | 28              | 17               | 0                     | -300 | 30              | 20              |
| <b>250</b> | <b>315</b> | 0                      | -25 | 31              | 19               | 0                     | -350 | 35              | 25              |
| <b>315</b> | <b>400</b> | 0                      | -30 | 38              | 23               | 0                     | -400 | 40              | 30              |

## Outer ring

| D<br>over  | incl.      | $\Delta_{Dmp}$<br>high | low | $V_{Dp}$<br>max | $V_{Dmp}$<br>max | $\Delta_{Cs}, V_{Cs}$                                                                                    | $K_{ea}$<br>max |
|------------|------------|------------------------|-----|-----------------|------------------|----------------------------------------------------------------------------------------------------------|-----------------|
| mm         |            | $\mu\text{m}$          |     | $\mu\text{m}$   | $\mu\text{m}$    |                                                                                                          | $\mu\text{m}$   |
| <b>6</b>   | <b>18</b>  | 0                      | -7  | 9               | 5                | Values are<br>identical to<br>those for<br>inner ring<br>of same<br>bearing<br>( $\Delta_{Bs}, V_{Bs}$ ) | 8               |
| <b>18</b>  | <b>30</b>  | 0                      | -8  | 10              | 6                |                                                                                                          | 9               |
| <b>30</b>  | <b>50</b>  | 0                      | -9  | 11              | 7                |                                                                                                          | 10              |
| <b>50</b>  | <b>80</b>  | 0                      | -11 | 14              | 8                |                                                                                                          | 13              |
| <b>80</b>  | <b>120</b> | 0                      | -13 | 16              | 10               |                                                                                                          | 18              |
| <b>120</b> | <b>150</b> | 0                      | -15 | 19              | 11               |                                                                                                          | 20              |
| <b>150</b> | <b>180</b> | 0                      | -18 | 23              | 14               |                                                                                                          | 23              |
| <b>180</b> | <b>250</b> | 0                      | -20 | 25              | 15               |                                                                                                          | 25              |
| <b>250</b> | <b>315</b> | 0                      | -25 | 31              | 19               |                                                                                                          | 30              |
| <b>315</b> | <b>400</b> | 0                      | -28 | 35              | 21               |                                                                                                          | 35              |
| <b>400</b> | <b>500</b> | 0                      | -33 | 41              | 25               |                                                                                                          | 40              |

Table 4

Class P5 tolerances for radial bearings

Inner ring

| d<br>over | incl. | $\Delta_{dmp}$ |     | $V_{dp}$<br>max | $V_{dmp}$<br>max | $\Delta_{Bs}$ |      | $V_{Bs}$<br>max | $K_{ia}$<br>max | $S_d$<br>max |
|-----------|-------|----------------|-----|-----------------|------------------|---------------|------|-----------------|-----------------|--------------|
|           |       | high           | low |                 |                  | high          | low  |                 |                 |              |
| mm        |       | $\mu m$        |     | $\mu m$         | $\mu m$          | $\mu m$       |      | $\mu m$         | $\mu m$         | $\mu m$      |
| 2,5       | 10    | 0              | -5  | 5               | 3                | 0             | -40  | 5               | 4               | 7            |
| 10        | 18    | 0              | -5  | 5               | 3                | 0             | -80  | 5               | 4               | 7            |
| 18        | 30    | 0              | -6  | 6               | 3                | 0             | -120 | 5               | 4               | 8            |
| 30        | 50    | 0              | -8  | 8               | 4                | 0             | -120 | 5               | 5               | 8            |
| 50        | 80    | 0              | -9  | 9               | 5                | 0             | -150 | 6               | 5               | 8            |
| 80        | 120   | 0              | -10 | 10              | 5                | 0             | -200 | 7               | 6               | 9            |
| 120       | 180   | 0              | -13 | 13              | 7                | 0             | -250 | 8               | 8               | 10           |
| 180       | 250   | 0              | -15 | 15              | 8                | 0             | -300 | 10              | 10              | 11           |
| 250       | 315   | 0              | -18 | 18              | 9                | 0             | -350 | 13              | 13              | 13           |
| 315       | 400   | 0              | -23 | 23              | 12               | 0             | -400 | 15              | 15              | 15           |

Outer ring

| D<br>over | incl. | $\Delta_{Dmp}$ |     | $V_{Dp}$<br>max | $V_{Dmp}$<br>max | $\Delta_{Cs}$                                                                          | $V_{Cs}$<br>max | $K_{ea}$<br>max | $S_D$<br>max |
|-----------|-------|----------------|-----|-----------------|------------------|----------------------------------------------------------------------------------------|-----------------|-----------------|--------------|
|           |       | high           | low |                 |                  |                                                                                        |                 |                 |              |
| mm        |       | $\mu m$        |     | $\mu m$         | $\mu m$          |                                                                                        | $\mu m$         | $\mu m$         | $\mu m$      |
| 6         | 18    | 0              | -5  | 5               | 3                | Values are identical to those for inner ring of same bearing ( $\Delta_{Bs}, V_{Bs}$ ) | 5               | 5               | 8            |
| 18        | 30    | 0              | -6  | 6               | 3                |                                                                                        | 5               | 6               | 8            |
| 30        | 50    | 0              | -7  | 7               | 4                |                                                                                        | 5               | 7               | 8            |
| 50        | 80    | 0              | -9  | 9               | 5                |                                                                                        | 6               | 8               | 8            |
| 80        | 120   | 0              | -10 | 10              | 5                |                                                                                        | 8               | 10              | 9            |
| 120       | 150   | 0              | -11 | 11              | 6                |                                                                                        | 8               | 11              | 10           |
| 150       | 180   | 0              | -13 | 13              | 7                |                                                                                        | 8               | 13              | 10           |
| 180       | 250   | 0              | -15 | 15              | 8                |                                                                                        | 10              | 15              | 11           |
| 250       | 315   | 0              | -18 | 18              | 9                |                                                                                        | 11              | 18              | 13           |
| 315       | 400   | 0              | -20 | 20              | 10               |                                                                                        | 13              | 20              | 13           |
| 400       | 500   | 0              | -23 | 23              | 12               |                                                                                        | 15              | 23              | 15           |

Table 6

## Chamfer dimension limits

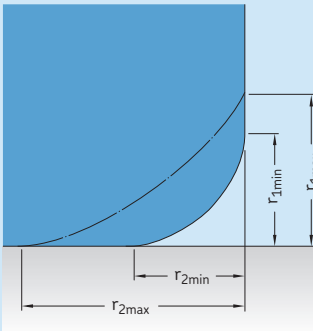

| Minimum value<br>$r_{s \min}$ | Nominal bearing bore diameter |       | Maximum values                  |                                 |                                   |
|-------------------------------|-------------------------------|-------|---------------------------------|---------------------------------|-----------------------------------|
|                               | over                          | incl. | Radial bearings<br>$r_{1 \max}$ | Radial bearings<br>$r_{2 \max}$ | Thrust bearings<br>$r_{1,2 \max}$ |
| mm                            | mm                            | mm    | mm                              | mm                              | mm                                |
| <b>0,1</b>                    | –                             | –     | 0,2                             | 0,4                             | 0,2                               |
| <b>0,15</b>                   | –                             | –     | 0,3                             | 0,6                             | 0,3                               |
| <b>0,2</b>                    | –                             | –     | 0,5                             | 0,8                             | 0,5                               |
| <b>0,3</b>                    | –                             | 40    | 0,6                             | 1                               | 0,8                               |
|                               | 40                            | –     | 0,8                             | 1                               | 0,8                               |
| <b>0,6</b>                    | –                             | 40    | 1                               | 2                               | 1,5                               |
|                               | 40                            | –     | 1,3                             | 2                               | 1,5                               |
| <b>1</b>                      | –                             | 50    | 1,5                             | 3                               | 2,2                               |
|                               | 50                            | –     | 1,9                             | 3                               | 2,2                               |
| <b>1,1</b>                    | –                             | 120   | 2                               | 3,5                             | 2,7                               |
|                               | 120                           | –     | 2,5                             | 4                               | 2,7                               |
| <b>1,5</b>                    | –                             | 120   | 2,3                             | 4                               | 3,5                               |
|                               | 120                           | –     | 3                               | 5                               | 3,5                               |
| <b>2</b>                      | –                             | 80    | 3                               | 4,5                             | 4                                 |
|                               | 80                            | 220   | 3,5                             | 5                               | 4                                 |
|                               | 220                           | –     | 3,8                             | 6                               | 4                                 |
| <b>2,1</b>                    | –                             | 280   | 4                               | 6,5                             | 4,5                               |
|                               | 280                           | –     | 4,5                             | 7                               | 4,5                               |

## Limits for chamfer dimensions

Minimum values for the chamfer dimensions are listed in the product tables. To prevent the improper dimensioning of fillets on associated components for needle roller bearings and to facilitate the calculation of snap ring location arrangements, the maximum chamfer limits for the relevant minimum value of chamfer dimensions are listed in **table 6**. These limits are in accordance with ISO 582:1995. The symbols used are explained below:

- $d$  nominal bearing bore diameter
- $r_1$  maximum value in the radial direction
- $r_2$  maximum value in the axial direction
- $r_{s \min}$  general symbol for the minimum value of chamfer dimensions

Table 5

## Normal tolerance class for washers and thrust bearings

## Shaft washer, WS

| $d$        |            | $\Delta_{dmp}$ |               | $V_{dp}$      | $S_i^{1)}$    | $\Delta_{Ts}^{1)}$ |               |
|------------|------------|----------------|---------------|---------------|---------------|--------------------|---------------|
|            |            | high           | low           |               |               | max                | low           |
| over       | incl.      | high           | low           | max           | max           | high               | low           |
| mm         | mm         | $\mu\text{m}$  | $\mu\text{m}$ | $\mu\text{m}$ | $\mu\text{m}$ | $\mu\text{m}$      | $\mu\text{m}$ |
| –          | <b>18</b>  | 0              | –8            | 6             | 10            | +20                | –250          |
| <b>18</b>  | <b>30</b>  | 0              | –10           | 8             | 10            | +20                | –250          |
| <b>30</b>  | <b>50</b>  | 0              | –12           | 9             | 10            | +20                | –250          |
| <b>50</b>  | <b>80</b>  | 0              | –15           | 11            | 10            | +20                | –250          |
| <b>80</b>  | <b>120</b> | 0              | –20           | 15            | 15            | +25                | –300          |
| <b>120</b> | <b>180</b> | 0              | –25           | 19            | 15            | +25                | –300          |

## Housing washer, GS

| $d$        |            | $\Delta_{dmp}$ |               | $V_{Dp}$      | $S_e$         |
|------------|------------|----------------|---------------|---------------|---------------|
|            |            | high           | low           |               |               |
| over       | incl.      | high           | low           | max           |               |
| mm         | mm         | $\mu\text{m}$  | $\mu\text{m}$ | $\mu\text{m}$ | $\mu\text{m}$ |
| <b>18</b>  | <b>30</b>  | 0              | –13           | 10            | 10            |
| <b>30</b>  | <b>50</b>  | 0              | –16           | 12            | 10            |
| <b>50</b>  | <b>80</b>  | 0              | –19           | 14            | 10            |
| <b>80</b>  | <b>120</b> | 0              | –19           | 14            | 10            |
| <b>120</b> | <b>180</b> | 0              | –25           | 19            | 15            |
| <b>180</b> | <b>250</b> | 0              | –30           | 23            | 20            |

<sup>1)</sup> Also valid where raceway washers in the LS series are used

## Internal clearance

Bearing internal clearance is defined as the total distance through which one bearing ring can be moved relative to the other in the radial direction (radial internal clearance) or in the axial direction (axial internal clearance).

It is necessary to distinguish between the internal clearance in a bearing before mounting and the internal clearance in a mounted bearing that has reached its operating temperature (operational clearance). The initial internal clearance (before mounting) is greater than the operational clearance because the degree of the interference fits and the effects of thermal expansion of the bearing rings and associated components will expand or compress the rings.

Bearing internal clearance referred to as Normal has been selected so that a suitable operational clearance will be obtained when the bearing is mounted with the recommended fits and operating under normal conditions. In applications where conditions are not normal,

e.g. where interference fits are used for both bearing rings, unusual temperatures prevail, or bearings with greater or smaller internal clearance than Normal are required, SKF recommends checking residual clearance in the bearing after it has been mounted.

Unless otherwise stated, SKF needle roller bearings with an inner ring have Normal radial internal clearance. Bearings having an internal clearance other than Normal are identified by the designation suffix C2, C3 or C4. The clearance values (→ **table 7**) are in accordance with ISO 5753-1:2009 and are valid for unmounted bearings under zero measuring load.

Table 7

Radial internal clearance for needle roller bearings and track runner bearings

| Bore diameter<br>d <sup>1)</sup> |       | Radial internal clearance |     |        |     |     |     |     |     |
|----------------------------------|-------|---------------------------|-----|--------|-----|-----|-----|-----|-----|
|                                  |       | C2                        |     | Normal |     | C3  |     | C4  |     |
| over                             | incl. | min                       | max | min    | max | min | max | min | max |
| mm                               |       | µm                        |     |        |     |     |     |     |     |
| –                                | 30    | 0                         | 25  | 20     | 45  | 35  | 60  | 50  | 75  |
| 30                               | 40    | 5                         | 30  | 25     | 50  | 45  | 70  | 60  | 85  |
| 40                               | 50    | 5                         | 35  | 30     | 60  | 50  | 80  | 70  | 100 |
| 50                               | 65    | 10                        | 40  | 40     | 70  | 60  | 90  | 80  | 110 |
| 65                               | 80    | 10                        | 45  | 40     | 75  | 65  | 100 | 90  | 125 |
| 80                               | 100   | 15                        | 50  | 50     | 85  | 75  | 110 | 105 | 140 |
| 100                              | 120   | 15                        | 55  | 50     | 90  | 85  | 125 | 125 | 165 |
| 120                              | 140   | 15                        | 60  | 60     | 105 | 100 | 145 | 145 | 190 |
| 140                              | 160   | 20                        | 70  | 70     | 120 | 115 | 165 | 165 | 215 |
| 160                              | 180   | 25                        | 75  | 75     | 125 | 120 | 170 | 170 | 220 |
| 180                              | 200   | 35                        | 90  | 90     | 145 | 140 | 195 | 195 | 250 |
| 200                              | 225   | 45                        | 105 | 105    | 165 | 160 | 220 | 220 | 280 |
| 225                              | 250   | 45                        | 110 | 110    | 175 | 170 | 235 | 235 | 300 |
| 250                              | 280   | 55                        | 125 | 125    | 195 | 190 | 260 | 260 | 330 |
| 280                              | 315   | 55                        | 130 | 130    | 205 | 200 | 275 | 275 | 350 |
| 315                              | 355   | 65                        | 145 | 145    | 225 | 225 | 305 | 305 | 385 |
| 355                              | 400   | 100                       | 190 | 190    | 280 | 280 | 370 | 370 | 460 |

<sup>1)</sup> For cam followers, the stud shank diameter d can be used as the bore diameter reference.

## Cages

Bearing cages can influence the suitability of a rolling bearing for a particular application. Their main purposes are:

- to separate the rolling elements and keep them spaced evenly for uniform load distribution
- to reduce noise levels
- to guide the rolling elements in the unloaded zone to improve rolling conditions and prevent damaging sliding movements
- to retain the rolling elements when mounting separable bearings

Cages are stressed by friction, inertia forces and heat. Depending on the material, cages can also be affected by certain lubricants, lubricant additives, organic solvents, coolants, or by-products of these substances as they age. Therefore, cage design and material are of paramount importance for the performance and the operational reliability of the bearing.

For larger bearings, the standard cage may be different than the one used in smaller bearings even though they are in the same design or series. In the introductory text of each product chapter, information is provided about standard cages.

## Seals

The seals integrated in a needle roller bearing can have a considerable impact on the performance and reliability of the bearing. Their primary purpose is to exclude solid contaminants and moisture and retain the lubricant in the bearing. The seal materials must withstand oxidation and offer excellent thermal or chemical resistance. Integral seals are generally contact seals or sliding rings.

Depending on the internal geometry and design of the bearing, the arrangement of the bearing and associated components can form non-contact seals and act as efficient labyrinth or gap-type seals.

Additional information about seals is available in the introductory text of each product chapter, if seals are available.

In addition to integral bearing seals, SKF also supplies an assortment of radial shaft seals that can be used as external seals. Appropriate seals are listed in the product tables, if available. For

additional information, refer to the section *Radial shaft seals with a low cross sectional height*, starting on **page 208**.

## Materials

The material used to make a bearing component determines, to a large extent, the performance and reliability of that bearing. For the bearing rings and rolling elements, typical considerations include hardness for load carrying capacity, fatigue resistance under rolling contact conditions, under clean or contaminated lubrication conditions, and the dimensional stability of the bearing components.

For additional information about seal materials, refer to the *SKF General Catalogue*. The general information about materials also applies to needle roller bearings.

### Materials for bearing rings and rolling elements

The standard steel used to produce machined rings and rolling elements of SKF needle roller bearings is a carbon chromium steel for through-hardening, containing approximately 1% carbon and 1,5% chromium, in accordance with ISO 683:17:1999.

Unless otherwise stated in the product chapters, bearing washers are also made of this carbon chromium bearing steel.

The thin-walled deep drawn outer rings of drawn cup needle roller bearings and the drawn sheet steel sleeve of alignment needle roller bearings are exceptions. They are made of mild steel in accordance with EN 10139:1997.

The majority of outer rings of track runner bearings are made of bearing steels for case-hardening because of their ability to withstand heavy shock loads. Materials that can be used are chromium-nickel and manganese-chromium alloyed steel in accordance with ISO 683-17:1999.

Standard needle roller bearings and track runner bearings made of carbon chromium steel or steel for case hardening are heat stabilized up to 120 °C unless otherwise stated in the introductory text of the product chapter. Bearings used in applications where temperatures exceed 120 °C must be subjected to a special heat stabilization process to provide adequate dimensional stability.

### Cage materials

#### Polyamide 66

Polyamide 66, with glass fibre reinforcement, is used for cages in many needle roller bearings and thrust bearings. Polyamide 66 is characterized by a favourable combination of strength and elasticity.

Due to its excellent sliding properties on lubricated steel surfaces and the superior finish of the contact surfaces, polyamide 66 cages promote low friction, low heat generation and low wear.

Polyamide 66 can be used for operating temperatures ranging from  $-40$  to  $+120$  °C, provided it does not come in contact with aggressive lubricants. Aggressive lubricants (e.g. oils with EP additives or some synthetic oils) promote ageing effects that can be compensated for by reducing the normal operating temperature. At temperatures below  $-40$  °C, polyamide loses its elasticity, which can result in cage failures. For additional information about the cage material, particularly the relationship between the operating temperatures and the cage ageing life, refer to the SKF *General Catalogue*.

#### Steel cages

Steel cages can be used at operating temperatures up to  $300$  °C. They are not affected either by mineral or synthetic oil-based lubricants or by the organic solvents used to clean a bearing. They are designed as window-type cage.

Sheet steel cages are pressed from continuously hot-rolled low carbon steel. These lightweight cages have relatively high strength and can be surface treated to further reduce friction and wear.

Machined steel cages are made of non-alloyed structural steel. To improve sliding and wear-resistance, some machined steel cages are surface treated.

### Seal materials

#### Acrylonitrile-butadiene rubber (NBR)

Acrylonitrile-butadiene rubber (NBR) is the "universal" seal material. This copolymer, produced from acrylonitrile and butadiene, shows good resistance to the following media:

- most mineral oils and greases with a mineral oil base
- normal fuels: petrol, diesel and light heating oils
- animal and vegetable oils and fats
- hot water

NBR also tolerates short-term dry running of the sealing lip. The permissible operating temperature range is  $-40$  to  $+100$  °C. For brief periods, temperatures of up to  $120$  °C can be tolerated. At higher temperatures, the material hardens.

#### Polyurethane

Polyurethane (AU) is a wear-resistant organic material with good elastic properties. It is resistant to mineral oil based greases and lubricating oils, even those containing small quantities of EP (Extreme Pressure) additives. The permissible operating temperature range is  $-30$  to  $+100$  °C.

#### Fluoro rubber

Fluoro rubbers (FKM) are characterized by their high thermal and chemical resistance. Their resistance to ageing and ozone is very good and their gas permeability is very slight. They have exceptionally good wear characteristics even under harsh environmental conditions and can withstand operating temperatures up to  $200$  °C. Seals made from this material can tolerate dry running of the lip for short periods.

Fluoro rubbers are also resistant to oils and hydraulic fluids, fuels and lubricants, mineral acids and aliphatic, as well as aromatic hydrocarbons, which would cause seals made from other materials to fail. In the presence of esters, ethers, ketones, certain amines and hot anhydrous hydrofluorides, fluoro rubbers should not be used.

#### Note

At temperatures above  $300$  °C, fluoro rubber gives off dangerous fumes. As handling seals made of fluoro rubber constitutes a potential safety risk, the safety precautions mentioned hereafter must always be followed.

**WARNING!****Safety precautions for fluoro rubber**

Fluoro rubber is very stable under normal operating conditions up to 200 °C. At temperatures above 200 °C, the material hardens and loses its effectiveness.

**At temperatures above 300 °C, which is usually the result of a fire or the flame of a cutting torch, fluoro rubber seals will give off hazardous fumes which can be harmful to the eyes and, if inhaled, to the respiratory system.**

Once fluoro rubber has been heated to 300 °C or above, it is dangerous to handle, **even after it has cooled.** Therefore, the following safety precautions should be observed when handling such material:

- Always wear protective goggles, gloves and appropriate breathing apparatus.
- Place the remains of the seals in an airtight plastic container marked with a symbol for “material will etch”.
- Follow the safety precautions in the appropriate material safety data sheet (MSDS).

Anyone who contacts these seals or their remains should wash their hands with soap and plenty of water and flush eyes with plenty of water and consult a doctor immediately. If the fumes have been inhaled, they should consult a doctor immediately.

The user is responsible for the correct use of the product during its service life and its proper disposal.

## Supplementary designations

The complete designation for needle roller and track runner bearings consists of a basic designation, which identifies bearing type and size, as well as supplementary designations. These designation suffixes identify design features that differ from the standard design. Where several supplementary designations are used to identify a particular bearing, they are always written in a specific order. The supplementary designations listed below are not exhaustive, but include those most commonly used.

### Suffix Description

|              |                                                                                                                                                                                                                                                                                                      |
|--------------|------------------------------------------------------------------------------------------------------------------------------------------------------------------------------------------------------------------------------------------------------------------------------------------------------|
| <b>A</b>     | NUTR design support rollers and NUKR design cam followers with an improved crowned profile of the outer ring running surface                                                                                                                                                                         |
| <b>AS..</b>  | Lubrication hole(s) in the outer ring, a figure following indicates the number of holes                                                                                                                                                                                                              |
| <b>ASR..</b> | Annular groove and lubrication hole(s) in the outer ring, a figure following indicates the number of holes                                                                                                                                                                                           |
| <b>B</b>     | KR design cam followers with a crowned profile of the outer ring running surface and a recessed hexagon on both ends of the stud                                                                                                                                                                     |
| <b>BF</b>    | Needle roller with flat ends                                                                                                                                                                                                                                                                         |
| <b>C2</b>    | Bearing internal clearance smaller than Normal                                                                                                                                                                                                                                                       |
| <b>C3</b>    | Bearing internal clearance greater than Normal                                                                                                                                                                                                                                                       |
| <b>CN</b>    | Bearing internal clearance Normal, only used together with an additional letter (H, L, M, P) that identifies a reduced or displaced clearance range                                                                                                                                                  |
| <b>C4</b>    | Bearing internal clearance greater than C3                                                                                                                                                                                                                                                           |
| <b>D</b>     | Deviating or modified internal design with the same boundary dimensions. Generally dropped after a certain changeover period, but may have the significance to bound to the particular bearing design/series<br>Example:<br>K 40×45×17 D<br>Needle roller and cage assembly with a double split cage |
| <b>DS</b>    | Single split needle roller and cage assembly                                                                                                                                                                                                                                                         |

|                |                                                                                                                                                                                                                                                                                                                                                                                                                          |
|----------------|--------------------------------------------------------------------------------------------------------------------------------------------------------------------------------------------------------------------------------------------------------------------------------------------------------------------------------------------------------------------------------------------------------------------------|
| <b>EGS</b>     | Inner ring with a non-directionally ground raceway                                                                                                                                                                                                                                                                                                                                                                       |
| <b>G2</b>      | Needle roller in accordance with ISO 3096:1996 Grade 2                                                                                                                                                                                                                                                                                                                                                                   |
| <b>H..</b>     | Needle roller bearing without an inner ring, with reduced inside diameter (under rollers) tolerance, followed by tolerance limits in $\mu\text{m}$ , e.g. H+27+20                                                                                                                                                                                                                                                        |
| <b>IS..</b>    | Needle roller bearing with one or more lubricating holes in the inner ring, a figure following indicates the number of holes                                                                                                                                                                                                                                                                                             |
| <b>ISR..</b>   | Needle roller bearing with an annular groove and one or more lubricating holes in the inner ring, a figure following indicates the number of holes                                                                                                                                                                                                                                                                       |
| <b>M../M..</b> | Diameter tolerance of needle rollers, e.g. M2/M4 indicates diameter tolerance $-2$ to $-4 \mu\text{m}$                                                                                                                                                                                                                                                                                                                   |
| <b>N/M..</b>   | Diameter tolerance of needle rollers, e.g. N/M2 indicates diameter tolerance $0$ to $-2 \mu\text{m}$                                                                                                                                                                                                                                                                                                                     |
| <b>P5</b>      | Dimensional and running accuracies to ISO tolerance class 5                                                                                                                                                                                                                                                                                                                                                              |
| <b>P6</b>      | Dimensional and running accuracies to ISO tolerance class 6                                                                                                                                                                                                                                                                                                                                                              |
| <b>P6CNR</b>   | P6 + CNR                                                                                                                                                                                                                                                                                                                                                                                                                 |
| <b>P62</b>     | P6 + C2                                                                                                                                                                                                                                                                                                                                                                                                                  |
| <b>P63</b>     | P6 + C3                                                                                                                                                                                                                                                                                                                                                                                                                  |
| <b>PPA</b>     | <ol style="list-style-type: none"> <li>NATR or NATV design support rollers with a polyamide 66 axial sliding and sealing ring on both sides. Improved crowned profile of the outer ring running surface.</li> <li>KR design cam followers have the same features as listed above. Sizes 16 and 19 have one slot in the head of the stud as standard. Size 22 and larger have a recessed hexagon on both ends.</li> </ol> |
| <b>PPSKA</b>   | KR design cam followers, sizes 16 and 19, with a polyamide 66 axial sliding and sealing ring on both sides, improved crowned profile of the outer ring running surface and a hexagon recessed into the head of the stud. These cannot be relubricated.                                                                                                                                                                   |
| <b>PPXA</b>    | Cam followers with PPA features except for the outer ring running surface, which has a cylindrical profile                                                                                                                                                                                                                                                                                                               |
| <b>RS</b>      | Contact seal of acrylonitrile-butadiene rubber (NRB) with or without sheet steel reinforcement on one side of the bearing                                                                                                                                                                                                                                                                                                |



- .2RS** RS contact seal on both sides of the bearing
- ..S** Matched bearings for an equal distribution of the radial load. The figure preceding indicates the number of bearings, e.g. NK 50/25 TN/2S
- S** Radial shaft seals with low cross sectional height, rubber material is metal cased, e.g. G 6×12×2 S
- 2S** Two matched bearings for an equal distribution of radial load (refer to S, the figure preceding the S indicates the number of bearings)
- S0** Bearing rings or washers dimensionally stabilized for use at operating temperatures up to 150 °C
- S1** Bearing rings or washers dimensionally stabilized for use at operating temperatures up to 200 °C
- S2** Bearing rings or washers dimensionally stabilized for use at operating temperatures up to 250 °C
- S3** Bearing rings or washers dimensionally stabilized for use at operating temperatures up to 300 °C
- SM..** Special grease, two figures following identify the grease
- /SORT..** Tolerance grade of needle rollers of a needle roller and cage assembly, the figures following give the actual limits in µm, e.g. /SORT-2-4
- TN** Injection moulded cage of glass fibre reinforced polyamide 66
- VGS** Inner ring with a pre-ground raceway and a machining allowance
- VG052** Single split cage of polyethersulfone (PES)
- X** Track runner bearings with a cylindrical (flat) profile of the outer ring running surface
- XA** NUKR .. A and NUKRE .. A design cam followers with a cylindrical (flat) profile of the outer ring running surface
- Z** Combined needle roller bearings, axial bearing with a cover over the outside diameter without lubrication holes. Filled at the factory with a high-quality lithium base NLGI 2 grease.
- ZW** Double row needle roller and cage assembly
- .2ZL** Support rollers with a lamellar seal on both sides

# Application of bearings

The bearing arrangement of a rotating machine component such as a shaft generally requires locating and a non-locating bearing arrangement to support and locate the component radially and axially relative to the housing. As radial needle roller bearings can accommodate axial displacement within the bearing, they generally are used as non-locating bearings.

Needle roller thrust bearings can only accommodate axial loads acting in one direction. A double direction needle roller thrust bearing can be created by combining two needle roller and cage thrust assemblies and bearing washers with an intermediate washer. Radial loads must be accommodated by a combined needle roller bearing or a separate radial bearing.

Combined needle roller bearings can accommodate radial loads and axial loads in one direction only. Therefore, a second combined needle roller bearing is required to be able to take axial loads in the opposite direction (except NKIB series needle roller bearings that can accommodate axial loads in both directions).

For additional information about bearing arrangements, refer to the SKF *General Catalogue*. The application information for bearings provided in the SKF *General Catalogue* is also valid for needle roller bearings.

If necessary, the introductory text of each product chapter provides information about

- axial guidance
- axial and radial location
- recommended fits for shafts and housings

## Design of associated components

### Form and running accuracy

Good running accuracy, required speeds and low operating temperatures can only be achieved if the associated components and other mating parts are manufactured with equal precision as the needle roller bearings. Deviations from geometric form of associated seats and abutments must be kept to a minimum. The parts should be machined according to the following recommendations.

Table 1

#### Limits for ISO tolerance grades

| Nominal dimension<br>over<br>incl. | Tolerance grades<br>max | Tolerance grades |     |     |     |     |     |
|------------------------------------|-------------------------|------------------|-----|-----|-----|-----|-----|
|                                    |                         | IT2              | IT3 | IT4 | IT5 | IT6 | IT7 |
| mm                                 | µm                      |                  |     |     |     |     |     |
| <b>1</b>                           | <b>3</b>                | 1,2              | 2   | 3   | 4   | 6   | 10  |
| <b>3</b>                           | <b>6</b>                | 1,5              | 2,5 | 4   | 5   | 8   | 12  |
| <b>6</b>                           | <b>10</b>               | 1,5              | 2,5 | 4   | 6   | 9   | 15  |
| <b>10</b>                          | <b>18</b>               | 2                | 3   | 5   | 8   | 11  | 18  |
| <b>18</b>                          | <b>30</b>               | 2,5              | 4   | 6   | 9   | 13  | 21  |
| <b>30</b>                          | <b>50</b>               | 2,5              | 4   | 7   | 11  | 16  | 25  |
| <b>50</b>                          | <b>80</b>               | 3                | 5   | 8   | 13  | 19  | 30  |
| <b>80</b>                          | <b>120</b>              | 4                | 6   | 10  | 15  | 22  | 35  |
| <b>120</b>                         | <b>180</b>              | 5                | 8   | 12  | 18  | 25  | 40  |
| <b>180</b>                         | <b>250</b>              | 7                | 10  | 14  | 20  | 29  | 46  |
| <b>250</b>                         | <b>315</b>              | 8                | 12  | 16  | 23  | 32  | 52  |
| <b>315</b>                         | <b>400</b>              | 9                | 13  | 18  | 25  | 36  | 57  |
| <b>400</b>                         | <b>500</b>              | 10               | 15  | 20  | 27  | 40  | 63  |

## Dimensional tolerances

For bearings manufactured to Normal tolerances, the dimensional accuracy of cylindrical seats on the shaft should be at least grade 6 and in the housing at least grade 7. For bearings with higher accuracy, correspondingly better grades should be used. The numerical values of standard IT tolerance grades, in accordance with ISO 286-1:1988, are listed in **table 1**.

Table 2

### Accuracy of form and position for bearing seats on shafts and in housings

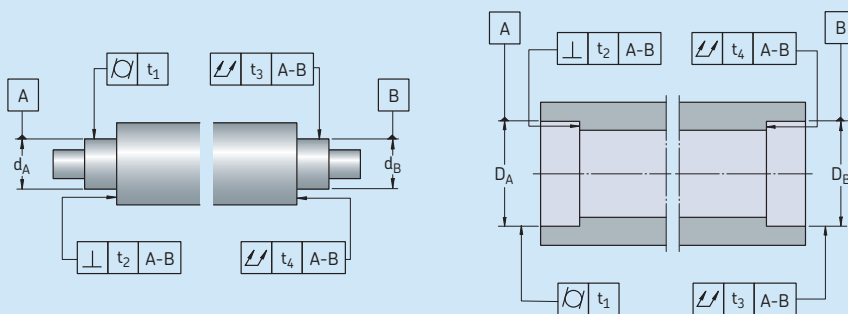

| Surface<br>Characteristic | Symbol for<br>characteristic | tolerance zone | Permissible deviation<br>Bearings of tolerance class <sup>1)</sup> |                 |                 |
|---------------------------|------------------------------|----------------|--------------------------------------------------------------------|-----------------|-----------------|
|                           |                              |                | Normal                                                             | P6              | P5              |
| <b>Cylindrical seat</b>   |                              |                |                                                                    |                 |                 |
| Cylindricity              | $\bigcirc$                   | $t_1$          | $\frac{IT5}{2}$                                                    | $\frac{IT4}{2}$ | $\frac{IT3}{2}$ |
| Total radial runout       | $\diagup$                    | $t_3$          | $\frac{IT5}{2}$                                                    | $\frac{IT4}{2}$ | $\frac{IT3}{2}$ |
| <b>Flat abutment</b>      |                              |                |                                                                    |                 |                 |
| Perpendicularity          | $\perp$                      | $t_2$          | IT5                                                                | IT4             | IT3             |
| Total axial runout        | $\diagup$                    | $t_4$          | IT5                                                                | IT4             | IT3             |

<sup>1)</sup> The basic tolerance classes stated are valid for normal demands on the bearing arrangement. For special demands in respect of running accuracy or even support, the bearing seat should be machined to the basic tolerance classes recommended for the next higher bearing tolerance class.

### Tolerances for cylindrical form

The cylindricity tolerances as defined in ISO 1101-2004 should be one to two IT grades better than the prescribed dimensional tolerance, depending on requirements. For example, if a bearing shaft seat has been manufactured to m6 tolerance class, then the accuracy of form should be to IT5 or IT4 tolerance grade. The tolerance value for cylindricity,  $t_1$ , is obtained for an assumed shaft diameter of 150 mm from  $t_1 = IT5/2 = 18/2 = 9 \mu\text{m}$ . However, the tolerance  $t_1$  is for a radius, hence  $2 t_1$  applies for the shaft diameter. Guideline values for the cylindrical form tolerance and the total runout tolerance for the different bearing tolerance classes are listed in **table 2 on page 49**.

### Tolerances for perpendicularity

Abutments for bearing rings should have a rectangularity tolerance as defined in ISO 1101-2004, which is better by at least one IT grade than the diameter tolerance of the associated cylindrical seat. For thrust bearing washer seats, the tolerance for perpendicularity should not exceed IT5 tolerance grade. Guideline values for the tolerance for rectangularity and for the total axial runout are listed in **table 2 on page 49**.

## Surface roughness of bearing seats

The surface roughness of a bearing seat does not have the same degree of influence on bearing performance as the dimensional, form and running accuracies. However, the accuracy of an interference fit is directly proportional to the smoothness of the mating surface.

For bearing arrangements where accuracy is a key operational parameter, guideline values for the mean surface roughness  $R_a$  are listed in **table 3**. These recommendations apply to ground seats, which are normally assumed for shaft seats.

## Raceways on shafts and in housings

### Raceway hardness and its influence

If the load carrying capacity of the bearing or assembly is to be fully exploited, the raceways machined in associated components must be hardened to between 58 and 64 HRC.

### Raceway surface finish and accuracy

The surface roughness should be  $R_a \leq 0,2 \mu\text{m}$  or  $R_z \leq 1 \mu\text{m}$ . For less demanding applications, rougher surfaces may be used.

The out-of-round and deviation from cylindrical form must not exceed 25 and 50%, respectively, of the actual diameter tolerance of the raceway.

The permissible axial runouts of raceways for thrust assemblies are the same as for the shaft and housing washers of thrust bearings, listed in **table 5 on page 41**.

### Raceway materials

Suitable materials for the raceways include steel for through-hardening, e.g. 100Cr6 in accordance with ISO 683-17:1999, steels for case-hardening, e.g. 20Cr3 or 17MnCr5 in accordance with ISO 683-17:1999) as well as steels for induction-hardening that can be surface hardened.

Table 3

Guideline values for surface roughness of bearing seats

| Diameter of seat $d(D)$ over | incl. | Recommended $R_a$ value for ground seats |          |          |
|------------------------------|-------|------------------------------------------|----------|----------|
|                              |       | Diameter tolerance to                    |          |          |
|                              |       | IT7                                      | IT6      | IT5      |
| mm                           |       | $\mu\text{m}$                            |          |          |
| –                            | 80    | 1,6 (N7)                                 | 0,8 (N6) | 0,4 (N5) |
| 80                           | 500   | 1,6 (N7)                                 | 1,6 (N7) | 0,8 (N6) |

The recommended hardening depth for raceways machined in associated components depends on various factors including the dynamic and static load ratios ( $P/C$  and  $P_0/C_0$  respectively) as well as the core hardness of the component. Therefore, it is difficult to make generalizations regarding hardening depth. For example, under conditions of purely static load up to the magnitude of the basic static load rating and with a core hardness of 350 HV, the recommended hardening depth is in the order of 0,1 times the rolling element diameter. For dynamic loads, however, smaller hardening depths are permitted. For additional information, contact the SKF application engineering service.

# Lubrication

If rolling bearings are to operate reliably they must be adequately lubricated to prevent direct metal-to-metal contact between the rolling elements, raceways and cages. The lubricant also inhibits wear and protects the bearing surfaces against corrosion. The choice of a suitable lubricant and method of lubrication for each individual bearing application is therefore important, as is adequate maintenance.

Differences in the lubricating properties of seemingly identical lubricants – particularly grease – produced at different locations can exist. As a result, SKF will not accept responsibility for the performance of any of its lubricants. The user is therefore advised to specify lubricant properties in detail so as to obtain the most suitable lubricant for the application.

## The SKF traffic light concept

Most grease suppliers indicate the specific values for the low and high temperature limits in their product information. The SKF traffic light concept is distinctly different from that. SKF recognizes that the really important temperatures for reliable operation lie within a smaller range. This range depends largely on the type of base oil and thickener used, as well as the additives. The relevant temperatures are given by the SKF traffic light concept. They are schematically illustrated in **diagram 1** in the form of a double traffic light.

It is clear that grease in the red zones should not be applied at all, as damage may occur. Within the green zone, the grease will function reliably and the grease life can be determined accurately.

At temperatures in the amber zone above the high temperature performance limit (HTPL), grease will age and oxidize with increasing rapidity and the by-products of the oxidation will have a detrimental effect on lubrication. An amber zone also exists for low temperatures. Short periods in this zone such as during a cold start are not harmful since the heat caused by friction will bring the bearing temperature into the green zone.

For additional information about the SKF traffic light concept, refer to the SKF *General Catalogue* (section *Lubrication*).

# Lubricating greases

The following explains basics concerning initial grease fills, if available, and gives recommendations for SKF greases that can be used for relubrication. Certain features, which facilitate efficient lubrication and relubrication of the bearings are provided in the introductory text of the individual product chapters.

For additional information about lubrication and calculation of relubrication intervals, refer to the SKF *General Catalogue* (section *Lubrication*). The SKF grease selection program *Lube Select* available online at [www.aptitudeexchange.com](http://www.aptitudeexchange.com) provides a more detailed selection of appropriate greases.

## Initial grease fill

### Sealed needle roller bearings and track runner bearings

The following bearings are filled at the factory with the same high-quality grease with good corrosion inhibiting properties:

- sealed needle roller bearings
- thrust part of combined bearings with the designation suffix Z
- cam followers
- support rollers

SKF recommends SKF LGWA 2 grease, if relubrication is required.

The most important technical specifications for grease for initial fill and for relubrication are listed in **table 1** on **page 54**.

Diagram 1

### The SKF traffic light concept – general

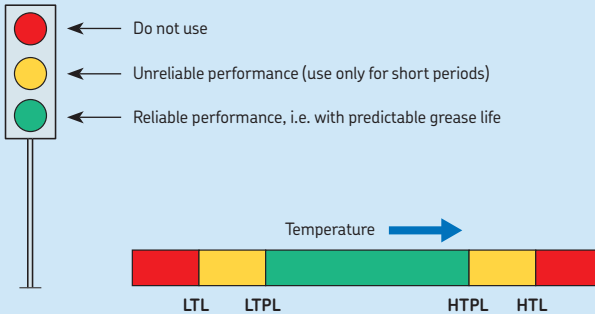

#### LTL – Low temperature limit

The lowest temperature at which the grease will enable the bearing to be started up without difficulty

#### LTPL – Low temperature performance limit

Below this limit, the supply of grease to the contact surfaces of rolling elements and raceways may become insufficient

#### HTPL – High temperature performance limit

Above this limit the grease will age and oxidize in an uncontrolled way, so that grease life cannot be determined accurately

#### HTL – High temperature limit





When exceeding this limit, the grease loses its structure permanently

## Lubrication

### Full complement drawn cup needle roller bearings

Special grease is used for full complement drawn cup needle roller bearings to secure the rollers during transportation. However, this grease does not provide sufficient long term lubrication. Therefore, relubrication after mounting may be necessary. Depending on the required consistency class, SKF recommends SKF LGEP 2 or SKF LGMW 1 greases for relubrication. Characteristics for the greases are listed in **table 2**.

Table 1

| Lubricating greases for sealed needle roller bearings and track runner bearings |                                                                                   |                                                                                   |
|---------------------------------------------------------------------------------|-----------------------------------------------------------------------------------|-----------------------------------------------------------------------------------|
|                                                                                 | Initial grease fill                                                               | LGWA 2                                                                            |
| <b>Thickener</b>                                                                | Lithium complex soap                                                              | Lithium complex soap                                                              |
| <b>Base oil type</b>                                                            | Mineral                                                                           | Mineral                                                                           |
| <b>NLGI consistency class</b>                                                   | 2                                                                                 | 2                                                                                 |
| <b>Temperature range<sup>1)</sup></b><br>[°C]                                   |  |  |
| [°F]                                                                            |  |  |
| <b>Base oil viscosity [mm<sup>2</sup>/s]</b><br>at 40 °C<br>at 100 °C           | 160<br>15,5                                                                       | 185<br>15                                                                         |

<sup>1)</sup> Refer to the SKF traffic light concept.

Table 2

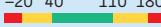
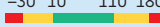
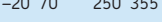
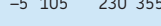
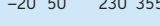
| Greases for full complement drawn cup needle roller bearings          |                                                                                     |                                                                                     |                                                                                     |
|-----------------------------------------------------------------------|-------------------------------------------------------------------------------------|-------------------------------------------------------------------------------------|-------------------------------------------------------------------------------------|
|                                                                       | Initial grease fill                                                                 | LGEP 2                                                                              | LGMW 1                                                                              |
| <b>Thickener</b>                                                      | Lithium soap                                                                        | Lithium soap                                                                        | Lithium soap                                                                        |
| <b>Base oil type</b>                                                  | Mineral                                                                             | Mineral                                                                             | Mineral                                                                             |
| <b>NLGI consistency class</b>                                         | 1 – 2                                                                               | 2                                                                                   | 1                                                                                   |
| <b>Temperature range<sup>1)</sup></b><br>[°C]                         |  |  |  |
| [°F]                                                                  |  |  |  |
| <b>Base oil viscosity [mm<sup>2</sup>/s]</b><br>at 40 °C<br>at 100 °C | 200<br>18,7                                                                         | 200<br>16                                                                           | 200<br>16                                                                           |

<sup>1)</sup> Refer to the SKF traffic light concept.







# Needle roller and cage assemblies

|                                            |    |
|--------------------------------------------|----|
| Dimensions.....                            | 58 |
| Tolerances .....                           | 60 |
| Operational clearance.....                 | 60 |
| Misalignment.....                          | 61 |
| Cages .....                                | 62 |
| Abutment dimensions.....                   | 63 |
| Supplementary designations.....            | 63 |
| Product tables .....                       | 64 |
| 2.1 Needle roller and cage assemblies..... | 64 |

## Needle roller and cage assemblies

Needle roller and cage assemblies are ready-to-mount, self-contained bearing components. They are an excellent choice for applications that require a very rigid bearing arrangement as well as a high load carrying capacity. If the shaft and housing bore can serve as raceways, needle roller and cage assemblies require minimal radial space.

### Standard needle roller and cage assemblies

SKF supplies needle roller and cage assemblies in single row (→ **fig. 1**) and double row (→ **fig. 2**) designs. They are characterized by:

- a simple and rugged design
- accurate guidance of the rollers in the cage pockets
- good running performance

### Other needle roller and cage assemblies

Only part of SKF's comprehensive assortment of needle roller and cage assemblies is listed in the product tables. SKF also supplies other sizes and assemblies with cages that differ from the standard design, such as needle roller and cage assemblies with a split cage (→ **fig. 3**) that can be used where raceways are recessed in the shaft.

For connecting rods of internal combustion engines and compressors, SKF supplies special needle roller and cage assemblies for the gudgeon (wrist) pin (→ **fig. 4**) and crank pin (crankshaft

journal) (→ **fig. 5**). The assemblies for these applications can provide excellent service in spite of high accelerations, high temperatures, unfavourable load conditions or poor lubrication conditions.

SKF also supplies special sizes of needle roller and cage assemblies to special order. Details of these other needle roller and cage assemblies are available on request.

## Dimensions

The dimensions of needle roller and cage assemblies with an inside diameter up to and including 100 mm, where standardized, are in accordance with ISO 3030:1996.

Fig. 1

Needle roller and cage assembly, single row

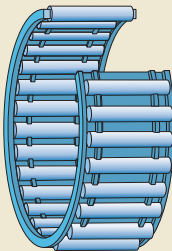

K series

Fig. 2

Needle roller and cage assembly, double row

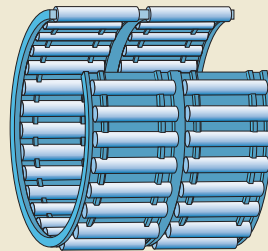

K .. ZW series

Bearing arrangement incorporating split needle roller and cage assemblies

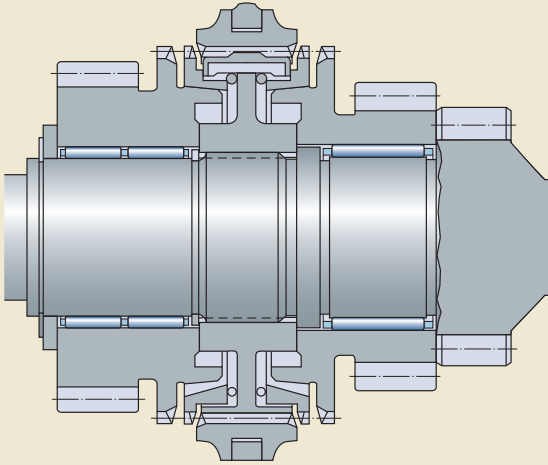

Fig. 4

Needle roller and cage assembly for gudgeon pin bearing arrangements

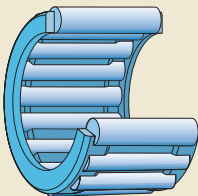
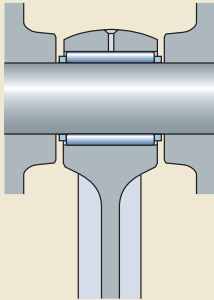
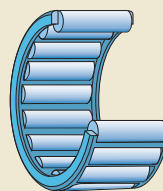
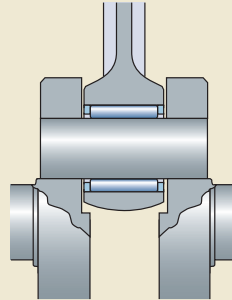

Fig. 5

Needle roller and cage assembly for crank pin bearing arrangements



## Tolerances

SKF needle roller and cage assemblies contain rollers of one gauge of grade G2 (ISO 3096: 1996 Grade 2). The tolerance of each gauge is 2 µm. The deviation from the nominal dimensions of the needle rollers is printed on the package.

SKF needle roller and cage assemblies may comprise, as standard, assemblies of any standard gauge (→ **table 1**). If a specific gauge is required, it must be stated when ordering. Assemblies with rollers of a special gauge (→ **table 1**) are only available by special order on request.

The tolerances for the width U are -0,20/-0,80 mm for all needle roller and cage assemblies.

### Paired mounting

Needle roller and cage assemblies that are mounted immediately adjacent to each other must incorporate rollers of the same gauge. This will enable both assemblies to share the load equally.

## Operational clearance

The radial operational clearance of bearing arrangements incorporating needle roller and cage assemblies is determined by:

- the gauge of the needle rollers
- the shaft and housing raceway tolerances
- the operating temperature

Suitable raceway tolerance classes are listed in **table 2**. If these tolerances are applied when using assemblies with standard gauge rollers (→ **table 1**), under normal conditions the operational clearance will reach a value in the range of C2 to Normal radial internal clearance (→ **table 7, page 42**).

If a specific radial internal clearance is required, the various components of the arrangement should be matched following a mounting scheme similar to the one shown in **table 3**. The mean value of the needle roller gauge should be used to calculate the internal clearance, e.g. -6 µm for the gauge -5 to -7 µm.

Table 1

| Needle roller gauges      |             |
|---------------------------|-------------|
| Gauge type                | Gauge in µm |
| Standard gauges           | 0/-2        |
|                           | -1/-3       |
|                           | -2/-4       |
|                           | -3/-5       |
|                           | -4/-6       |
|                           | -5/-7       |
| Special gauges (to order) | -6/-8       |
|                           | -7/-9       |
|                           | -8/-10      |
|                           | -9/-11      |

Table 2

| Raceway tolerance classes for needle roller and cage assemblies |                                                           |                                                           |             |             |
|-----------------------------------------------------------------|-----------------------------------------------------------|-----------------------------------------------------------|-------------|-------------|
| Shaft Nominal diameter                                          | Housing/shaft tolerance classes for operational clearance | Housing/shaft tolerance classes for operational clearance |             |             |
|                                                                 |                                                           | lower side                                                | medium side | higher side |
| over                                                            | incl.                                                     |                                                           |             |             |
| mm                                                              |                                                           | -                                                         |             |             |
| -                                                               | 80                                                        | G6/j5                                                     | G6/h5       | G6/g6       |
|                                                                 |                                                           | H6/h5                                                     | H6/g5       | H6/f6       |
| 80                                                              | 120                                                       | G6/h5                                                     | G6/g5       | G6/f6       |
|                                                                 |                                                           | 120                                                       | -           | G6/h5       |
| 120                                                             | -                                                         | G6/h5                                                     | G6/g5       | G6/f6       |
|                                                                 |                                                           | -                                                         | H6/f5       | H6/e6       |

# Misalignment

The ends of the needle rollers are relieved slightly to modify the line contact between the raceways and the rollers. This provides favourable load distribution in the needle roller and cage assembly and minimizes damaging edge stresses. It also enables single row needle roller and cage assemblies to accommodate a small amount of misalignment, approximately 1 min of arc between the shaft and housing.

The detrimental effects of misalignment increase with increasing bearing width and load. For additional information, contact the SKF application engineering service.

**Table 3**
**Mounting scheme – example**

Needle roller and cage assembly: K16×22×12  
 Housing bore diameter: 22H6 (mm), deviation 0/+13 μm  
 Shaft diameter: 16h5 (mm), deviation 0/−8 μm

| Shaft diameter<br>Deviation group | Housing bore diameter               |                                 |                                     |                                 |                                     |                                 |                                     |                                 |
|-----------------------------------|-------------------------------------|---------------------------------|-------------------------------------|---------------------------------|-------------------------------------|---------------------------------|-------------------------------------|---------------------------------|
|                                   | Deviation groups<br>0 to +3         |                                 | +3 to +6                            |                                 | +6 to +9                            |                                 | +9 to +13                           |                                 |
|                                   | Needle<br>roller<br>gauge<br>limits | Radial<br>internal<br>clearance | Needle<br>roller<br>gauge<br>limits | Radial<br>internal<br>clearance | Needle<br>roller<br>gauge<br>limits | Radial<br>internal<br>clearance | Needle<br>roller<br>gauge<br>limits | Radial<br>internal<br>clearance |
| μm                                | μm                                  |                                 |                                     |                                 |                                     |                                 |                                     |                                 |
| 0 to −3                           |                                     |                                 |                                     |                                 | −5/−7                               | 18–24                           | −3/−5                               | 17–24                           |
| −3 to −6                          |                                     |                                 | −5/−7                               | 18–24                           | −3/−5<br>−4/−6                      | 17–25                           | −2/−4                               | 18–25                           |
| −6 to −8                          | −5/−7<br>−6/−8                      | 18–25                           | −3/−5<br>−4/−6                      | 17–24                           | −2/−4<br>−3/−5                      | 18–25                           | 0/−2<br>−1/−3                       | 17–25                           |

## Cages

SKF needle roller and cage assemblies are fitted, as standard, with a machined steel cage (→ **fig. 6**) or a sheet steel cage (→ **fig. 7**), with the exception of assemblies identified by the designation suffix TN. These have an injection moulded glass fibre reinforced polyamide 66 cage (→ **fig. 8**).

### Note

Needle roller and cage assemblies with a polyamide 66 cage can be operated at temperatures up to 120 °C. The lubricants generally used for rolling bearings do not have a detrimental effect on cage properties. Exceptions are a few synthetic oils and greases with a synthetic oil base and lubricants containing a high proportion of EP additives when used at high temperatures.

For bearing arrangements that operate at continuously high temperatures or under arduous conditions, SKF recommends using assemblies with a steel cage.

For additional information about the temperature resistance and the applicability of cages, refer to the section *Cage materials*, starting on **page 44**.

Fig. 6

Machined steel cage

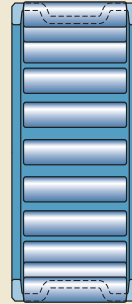

Fig. 7

Sheet steel cage

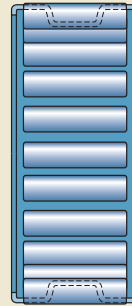

Fig. 8

Polyamide 66 cage

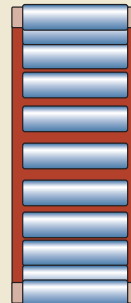



Table 4

## Abutment dimensions

Needle roller and cage assemblies should be axially guided. The lateral abutment surfaces should be fine turned and polished. For high speed operation they should be hardened and ground. Interruptions in the surface should be avoided. Snap rings can be used in less demanding applications, otherwise an intermediate ring, e.g. a spring steel washer, should be placed between the snap ring and the assembly. Appropriate values for the abutment diameters on the shaft and in the housing are listed in **table 4**.

## Supplementary designations

The designation suffixes used to identify certain features of SKF needle roller and cage assemblies are explained in the following.

- DS** Split needle roller and cage assembly  
**/SORT..** Tolerance grade of needle rollers of a needle roller and cage assembly, the figures following give the actual limits in  $\mu\text{m}$ , e.g. /SORT-2-4
- TN** Injection moulded cage of glass fibre reinforced polyamide 66
- VG052** Single split cage of polyethersulfone (PES)
- ZW** Double row needle roller and cage assembly (double row cage)

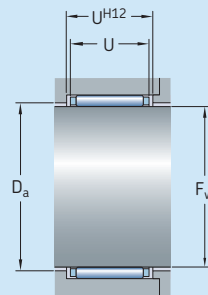
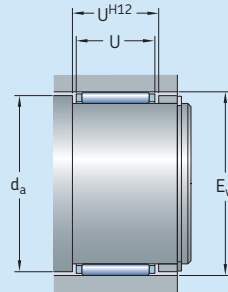

| Needle roller and cage assembly<br>Inside diameter |       | Shaft<br>abutment | Housing<br>abutment |
|----------------------------------------------------|-------|-------------------|---------------------|
| $F_w$<br>over                                      | incl. | $d_a$             | $D_a$               |
| mm                                                 |       | mm                | mm                  |
| –                                                  | 25    | $E_w-0,3$         | $F_w+0,4$           |
| 25                                                 | 65    | $E_w-0,5$         | $F_w+0,5$           |
| 65                                                 | –     | $E_w-1$           | $F_w+1$             |

## Needle roller and cage assemblies

F<sub>w</sub> 3 – 19 mm

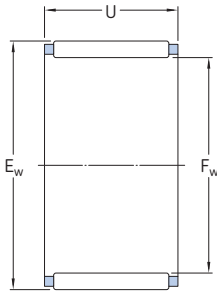

K

| Dimensions     |                |    | Basic load ratings |                | Fatigue load limit | Speed ratings   |                | Mass | Designation   | Appropriate seal <sup>1)</sup><br>Designation |
|----------------|----------------|----|--------------------|----------------|--------------------|-----------------|----------------|------|---------------|-----------------------------------------------|
| F <sub>w</sub> | E <sub>w</sub> | U  | dynamic            | static         |                    | Reference speed | Limiting speed |      |               |                                               |
|                |                |    | C                  | C <sub>0</sub> | P <sub>u</sub>     |                 |                |      |               |                                               |
| mm             |                |    | kN                 |                | kN                 | r/min           |                | g    | –             | –                                             |
| 3              | 5              | 7  | 1,51               | 1,34           | 0,134              | 40 000          | 45 000         | 0,3  | K 3×5×7 TN    | –                                             |
|                | 5              | 9  | 1,72               | 1,63           | 0,17               | 38 000          | 43 000         | 0,4  | K 3×5×9 TN    | –                                             |
|                | 6              | 7  | 1,42               | 1,02           | 0,104              | 38 000          | 43 000         | 0,4  | K 3×6×7 TN    | –                                             |
| 4              | 7              | 7  | 1,72               | 1,32           | 0,137              | 36 000          | 43 000         | 0,5  | K 4×7×7 TN    | –                                             |
|                | 7              | 10 | 2,29               | 1,9            | 0,204              | 36 000          | 43 000         | 0,7  | K 4×7×10 TN   | –                                             |
| 5              | 8              | 8  | 2,29               | 2              | 0,212              | 36 000          | 40 000         | 0,7  | K 5×8×8 TN    | –                                             |
|                | 8              | 10 | 2,92               | 2,7            | 0,29               | 36 000          | 40 000         | 0,9  | K 5×8×10 TN   | –                                             |
| 6              | 9              | 8  | 2,55               | 2,36           | 0,25               | 34 000          | 38 000         | 0,8  | K 6×9×8 TN    | –                                             |
|                | 9              | 10 | 3,3                | 3,2            | 0,345              | 34 000          | 38 000         | 1,1  | K 6×9×10 TN   | –                                             |
|                | 10             | 13 | 3,69               | 3,15           | 0,36               | 34 000          | 38 000         | 1,9  | K 6×10×13 TN  | G 6×10×2 S                                    |
| 7              | 9              | 7  | 1,68               | 1,83           | 0,19               | 34 000          | 38 000         | 0,6  | K 7×9×7 TN    | –                                             |
|                | 10             | 8  | 2,81               | 2,75           | 0,29               | 32 000          | 36 000         | 0,9  | K 7×10×8 TN   | –                                             |
|                | 10             | 10 | 3,58               | 3,75           | 0,415              | 32 000          | 36 000         | 1,0  | K 7×10×10 TN  | –                                             |
| 8              | 11             | 8  | 3,03               | 3,1            | 0,335              | 32 000          | 36 000         | 1,0  | K 8×11×8 TN   | –                                             |
|                | 11             | 10 | 3,8                | 4,25           | 0,465              | 32 000          | 36 000         | 1,2  | K 8×11×10 TN  | –                                             |
|                | 11             | 13 | 5,01               | 5,85           | 0,67               | 32 000          | 36 000         | 1,7  | K 8×11×13 TN  | –                                             |
|                | 12             | 10 | 4,84               | 4,75           | 0,54               | 30 000          | 34 000         | 2,0  | K 8×12×10 TN  | G 8×12×3                                      |
| 9              | 12             | 10 | 4,4                | 5,2            | 0,57               | 30 000          | 34 000         | 1,5  | K 9×12×10 TN  | –                                             |
|                | 12             | 13 | 5,72               | 7,2            | 0,815              | 30 000          | 34 000         | 2,1  | K 9×12×13 TN  | –                                             |
| 10             | 13             | 10 | 4,57               | 5,7            | 0,63               | 28 000          | 32 000         | 1,6  | K 10×13×10 TN | –                                             |
|                | 13             | 13 | 5,94               | 8              | 0,9                | 28 000          | 32 000         | 2,3  | K 10×13×13 TN | –                                             |
|                | 13             | 16 | 6,82               | 9,5            | 1,08               | 28 000          | 32 000         | 2,9  | K 10×13×16 TN | –                                             |
|                | 14             | 10 | 5,61               | 6,1            | 0,695              | 28 000          | 32 000         | 2,5  | K 10×14×10 TN | G 10×14×3                                     |
|                | 14             | 13 | 5,83               | 6,3            | 0,72               | 28 000          | 32 000         | 4,6  | K 10×14×13 TN | G 10×14×3                                     |
|                | 16             | 12 | 7,65               | 7,2            | 0,85               | 28 000          | 32 000         | 5,5  | K 10×16×12 TN | –                                             |
| 12             | 15             | 10 | 4,73               | 6,2            | 0,695              | 26 000          | 30 000         | 1,9  | K 12×15×10 TN | –                                             |
|                | 15             | 13 | 6,16               | 8,65           | 0,98               | 26 000          | 30 000         | 2,3  | K 12×15×13 TN | –                                             |
|                | 16             | 13 | 7,65               | 9,5            | 1,1                | 26 000          | 30 000         | 3,6  | K 12×16×13 TN | G 12×16×3                                     |
|                | 17             | 13 | 9,13               | 10,4           | 1,22               | 26 000          | 30 000         | 4,9  | K 12×17×13 TN | –                                             |
|                | 18             | 12 | 9,52               | 10             | 1,18               | 26 000          | 30 000         | 6,0  | K 12×18×12 TN | G/SD 12×18×3                                  |

<sup>1)</sup> For additional information, refer to the section *Radial shaft seals with a low cross sectional height*, starting on page 208.

| Dimensions     |                |    | Basic load ratings |                | Fatigue load limit | Speed ratings   |                | Mass | Designation          | Appropriate seal <sup>1)</sup> |
|----------------|----------------|----|--------------------|----------------|--------------------|-----------------|----------------|------|----------------------|--------------------------------|
| F <sub>w</sub> | E <sub>w</sub> | U  | C                  | C <sub>0</sub> | P <sub>u</sub>     | Reference speed | Limiting speed |      |                      | Designation                    |
| mm             |                |    | kN                 |                | kN                 | r/min           |                | g    | –                    | –                              |
| <b>14</b>      | 18             | 10 | 6,93               | 8,65           | 1                  | 24 000          | 28 000         | 4,0  | <b>K 14×18×10</b>    | –                              |
|                | 18             | 13 | 7,92               | 10,2           | 1,18               | 24 000          | 28 000         | 6,5  | <b>K 14×18×13</b>    | –                              |
|                | 18             | 15 | 9,13               | 12,5           | 1,46               | 24 000          | 28 000         | 5,0  | <b>K 14×18×15 TN</b> | –                              |
|                | 18             | 17 | 10,5               | 14,6           | 1,7                | 24 000          | 28 000         | 8,0  | <b>K 14×18×17</b>    | –                              |
|                | 20             | 12 | 9,9                | 10,6           | 1,25               | 24 000          | 28 000         | 8,5  | <b>K 14×20×12</b>    | G/SD 14×20×3                   |
| <b>15</b>      | 18             | 17 | 7,65               | 12,2           | 1,4                | 24 000          | 28 000         | 4,6  | <b>K 15×18×17 TN</b> | –                              |
|                | 19             | 10 | 7,21               | 9,3            | 1,06               | 24 000          | 28 000         | 5,0  | <b>K 15×19×10</b>    | –                              |
|                | 19             | 13 | 8,25               | 11,2           | 1,29               | 24 000          | 28 000         | 7,0  | <b>K 15×19×13</b>    | –                              |
|                | 19             | 17 | 10,8               | 15,6           | 1,86               | 24 000          | 28 000         | 9,5  | <b>K 15×19×17</b>    | –                              |
|                | 20             | 13 | 9,52               | 11,6           | 1,34               | 24 000          | 26 000         | 7,0  | <b>K 15×20×13</b>    | –                              |
|                | 21             | 15 | 13,8               | 16,3           | 2                  | 24 000          | 26 000         | 11   | <b>K 15×21×15</b>    | G/SD 15×21×3                   |
|                | 21             | 21 | 18,7               | 24,5           | 3                  | 24 000          | 26 000         | 17   | <b>K 15×21×21</b>    | G/SD 15×21×3                   |
| <b>16</b>      | 20             | 10 | 7,48               | 10             | 1,16               | 24 000          | 26 000         | 5,5  | <b>K 16×20×10</b>    | –                              |
|                | 20             | 13 | 8,58               | 12             | 1,37               | 24 000          | 26 000         | 7,5  | <b>K 16×20×13</b>    | –                              |
|                | 20             | 17 | 11,2               | 17             | 2                  | 24 000          | 26 000         | 10   | <b>K 16×20×17</b>    | –                              |
|                | 22             | 12 | 11                 | 12,5           | 1,5                | 22 000          | 26 000         | 10   | <b>K 16×22×12</b>    | G/SD 16×22×3                   |
|                | 22             | 16 | 14,2               | 17,6           | 2,12               | 22 000          | 26 000         | 12   | <b>K 16×22×16</b>    | G/SD 16×22×3                   |
|                | 22             | 20 | 17,6               | 22,8           | 2,8                | 22 000          | 26 000         | 17   | <b>K 16×22×20</b>    | G/SD 16×22×3                   |
|                | 24             | 20 | 20,5               | 23,6           | 2,9                | 22 000          | 24 000         | 22   | <b>K 16×24×20</b>    | G/SD 16×24×3                   |
|                | 24             | 20 | 20,5               | 23,6           | 2,9                | 22 000          | 24 000         | 22   | <b>K 16×24×20</b>    | G/SD 16×24×3                   |
| <b>17</b>      | 21             | 10 | 7,81               | 10,8           | 1,22               | 22 000          | 26 000         | 5,5  | <b>K 17×21×10</b>    | –                              |
|                | 21             | 13 | 10,1               | 14,6           | 1,73               | 22 000          | 26 000         | 6,5  | <b>K 17×21×13</b>    | –                              |
|                | 21             | 17 | 11,7               | 18,3           | 2,12               | 22 000          | 26 000         | 9,5  | <b>K 17×21×17</b>    | –                              |
| <b>18</b>      | 22             | 10 | 8,09               | 11,4           | 1,32               | 22 000          | 24 000         | 6,0  | <b>K 18×22×10</b>    | –                              |
|                | 22             | 13 | 8,8                | 12,9           | 1,5                | 22 000          | 24 000         | 8,0  | <b>K 18×22×13</b>    | –                              |
|                | 22             | 17 | 11,7               | 18,3           | 2,16               | 22 000          | 24 000         | 11   | <b>K 18×22×17</b>    | –                              |
|                | 24             | 12 | 12,1               | 15             | 1,8                | 20 000          | 24 000         | 12   | <b>K 18×24×12</b>    | G/SD 18×24×3                   |
|                | 24             | 13 | 12,5               | 15,3           | 1,86               | 20 000          | 24 000         | 13   | <b>K 18×24×13</b>    | G/SD 18×24×3                   |
|                | 24             | 20 | 19,4               | 27             | 3,25               | 20 000          | 24 000         | 18   | <b>K 18×24×20</b>    | G/SD 18×24×3                   |
|                | 25             | 22 | 22                 | 29             | 3,55               | 20 000          | 24 000         | 23   | <b>K 18×25×22</b>    | –                              |
| <b>19</b>      | 23             | 13 | 9,13               | 13,7           | 1,6                | 20 000          | 24 000         | 8,0  | <b>K 19×23×13</b>    | –                              |
|                | 23             | 17 | 12,1               | 19,3           | 2,28               | 20 000          | 24 000         | 11   | <b>K 19×23×17</b>    | –                              |

<sup>1)</sup> For additional information, refer to the section *Radial shaft seals with a low cross sectional height*, starting on **page 208**.

## Needle roller and cage assemblies

F<sub>w</sub> 20 – 30 mm

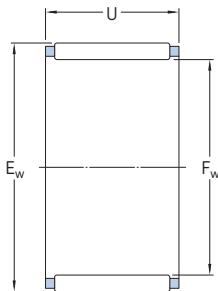

K

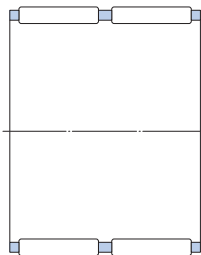

K..ZW

| Dimensions     |                |      | Basic load ratings |                          | Fatigue load limit | Speed ratings   |                | Mass       | Designation   | Appropriate seal <sup>1)</sup><br>Designation |
|----------------|----------------|------|--------------------|--------------------------|--------------------|-----------------|----------------|------------|---------------|-----------------------------------------------|
| F <sub>w</sub> | E <sub>w</sub> | U    | dynamic<br>C       | static<br>C <sub>0</sub> |                    | Reference speed | Limiting speed |            |               |                                               |
| mm             |                |      | kN                 |                          | kN                 | r/min           |                | g          | –             | –                                             |
| 20             | 24             | 10   | 8,58               | 12,9                     | 1,46               | 20 000          | 22 000         | 6,5        | K 20×24×10    | –                                             |
|                | 24             | 13   | 9,52               | 14,6                     | 1,66               | 20 000          | 22 000         | 9,0        | K 20×24×13    | –                                             |
|                | 24             | 17   | 12,5               | 20,8                     | 2,4                | 20 000          | 22 000         | 12         | K 20×24×17    | –                                             |
|                | 26             | 12   | 12,8               | 16,3                     | 1,96               | 19 000          | 22 000         | 11         | K 20×26×12    | G/SD 20×26×4                                  |
|                | 26             | 13   | 13,8               | 18                       | 2,16               | 19 000          | 22 000         | 12         | K 20×26×13    | G/SD 20×26×4                                  |
|                | 26             | 17   | 18,3               | 26                       | 3,2                | 19 000          | 22 000         | 16         | K 20×26×17    | G/SD 20×26×4                                  |
|                | 26             | 20   | 20,1               | 29                       | 3,6                | 19 000          | 22 000         | 19         | K 20×26×20    | G/SD 20×26×4                                  |
|                | 28             | 16   | 19                 | 22,4                     | 2,7                | 18 000          | 20 000         | 20         | K 20×28×16    | G/SD 20×28×4                                  |
|                | 28             | 20   | 22,9               | 28,5                     | 3,45               | 18 000          | 20 000         | 27         | K 20×28×20    | G/SD 20×28×4                                  |
|                | 28             | 25   | 29,2               | 39                       | 4,9                | 18 000          | 20 000         | 32         | K 20×28×25    | G/SD 20×28×4                                  |
| 30             | 30             | 34,1 | 41,5               | 5,2                      | 17 000             | 20 000          | 49             | K 20×30×30 | –             |                                               |
| 21             | 25             | 13   | 9,68               | 15,3                     | 1,76               | 19 000          | 22 000         | 9,0        | K 21×25×13    | –                                             |
| 22             | 26             | 10   | 8,8                | 13,7                     | 1,56               | 18 000          | 20 000         | 7,5        | K 22×26×10    | –                                             |
|                | 26             | 13   | 10,1               | 16,3                     | 1,86               | 18 000          | 20 000         | 9,5        | K 22×26×13    | –                                             |
|                | 26             | 17   | 13,2               | 22,8                     | 2,7                | 18 000          | 20 000         | 12         | K 22×26×17    | –                                             |
|                | 28             | 17   | 18,3               | 27                       | 3,25               | 17 000          | 20 000         | 18         | K 22×28×17    | G/SD 22×28×4                                  |
|                | 29             | 16   | 19,4               | 25,5                     | 3,05               | 17 000          | 19 000         | 16         | K 22×29×16    | –                                             |
|                | 30             | 15   | 19                 | 23,6                     | 2,8                | 17 000          | 19 000         | 18         | K 22×30×15 TN | G/SD 22×30×4                                  |
|                | 32             | 24   | 31,9               | 40                       | 4,9                | 16 000          | 18 000         | 43         | K 22×32×24    | –                                             |
| 23             | 35             | 16   | 24,2               | 23,2                     | 2,9                | 15 000          | 17 000         | 29         | K 23×35×16 TN | –                                             |
| 24             | 28             | 10   | 9,35               | 15                       | 1,73               | 17 000          | 19 000         | 8,5        | K 24×28×10    | –                                             |
|                | 28             | 13   | 10,6               | 18                       | 2,08               | 17 000          | 19 000         | 10         | K 24×28×13    | –                                             |
|                | 28             | 17   | 14                 | 25,5                     | 3                  | 17 000          | 19 000         | 13         | K 24×28×17    | –                                             |
|                | 30             | 17   | 18,7               | 27,5                     | 3,4                | 16 000          | 18 000         | 19         | K 24×30×17    | –                                             |
|                | 30             | 31   | 26,4               | 43                       | 5,3                | 16 000          | 18 000         | 32         | K 24×30×31 ZW | –                                             |

<sup>1)</sup> For additional information, refer to the section *Radial shaft seals with a low cross sectional height*, starting on page 208.

| Dimensions     |                |    | Basic load ratings |                | Fatigue load limit | Speed ratings   |                | Mass   | Designation   | Appropriate seal <sup>1)</sup><br>Designation |
|----------------|----------------|----|--------------------|----------------|--------------------|-----------------|----------------|--------|---------------|-----------------------------------------------|
| F <sub>w</sub> | E <sub>w</sub> | U  | C                  | C <sub>0</sub> | P <sub>u</sub>     | Reference speed | Limiting speed |        |               |                                               |
| mm             |                |    | kN                 |                | kN                 | r/min           |                | g      | –             | –                                             |
| 25             | 29             | 10 | 9,52               | 15,6           | 1,8                | 16 000          | 18 000         | 8,5    | K 25×29×10    | –                                             |
|                | 29             | 13 | 10,8               | 18,6           | 2,16               | 16 000          | 18 000         | 11     | K 25×29×13    | –                                             |
|                | 29             | 17 | 14,2               | 26,5           | 3,1                | 16 000          | 18 000         | 14     | K 25×29×17    | –                                             |
|                | 30             | 17 | 17,9               | 30,5           | 3,6                | 16 000          | 18 000         | 16     | K 25×30×17    | –                                             |
|                | 30             | 20 | 20,9               | 36,5           | 4,4                | 16 000          | 18 000         | 18     | K 25×30×20    | –                                             |
|                | 30             | 26 | 20,5               | 36             | 4,15               | 16 000          | 18 000         | 19     | K 25×30×26 ZW | –                                             |
|                | 31             | 17 | 18,7               | 28,5           | 3,45               | 16 000          | 18 000         | 19     | K 25×31×17    | –                                             |
|                | 31             | 21 | 23,3               | 38             | 4,75               | 16 000          | 18 000         | 20     | K 25×31×21    | –                                             |
|                | 32             | 16 | 19,8               | 27,5           | 3,35               | 15 000          | 17 000         | 21     | K 25×32×16    | G 25×32×4                                     |
|                | 33             | 20 | 27,5               | 38             | 4,65               | 15 000          | 17 000         | 33     | K 25×33×20    | G/SD 25×33×4                                  |
|                | 33             | 24 | 31,9               | 47,5           | 5,85               | 15 000          | 17 000         | 39     | K 25×33×24    | G/SD 25×33×4                                  |
|                | 35             | 30 | 44,6               | 62             | 7,8                | 15 000          | 17 000         | 65     | K 25×35×30    | G/SD 25×35×4                                  |
|                | 26             | 30 | 13                 | 11,2           | 19,6               | 2,28            | 16 000         | 18 000 | 11            | K 26×30×13                                    |
| 30             |                | 17 | 14,7               | 27,5           | 3,25               | 16 000          | 18 000         | 15     | K 26×30×17    | –                                             |
| 30             |                | 22 | 15,1               | 29             | 3,35               | 16 000          | 18 000         | 12     | K 26×30×22 ZW | –                                             |
| 28             | 33             | 13 | 14,7               | 24,5           | 2,85               | 14 000          | 16 000         | 13     | K 28×33×13    | –                                             |
|                | 33             | 17 | 19                 | 33,5           | 4,05               | 14 000          | 16 000         | 17     | K 28×33×17    | –                                             |
|                | 34             | 17 | 20,9               | 33,5           | 4,15               | 14 000          | 16 000         | 24     | K 28×34×17    | –                                             |
|                | 35             | 16 | 20,5               | 30             | 3,55               | 14 000          | 16 000         | 24     | K 28×35×16    | G/SD 28×35×4                                  |
|                | 35             | 18 | 22,9               | 34,5           | 4,15               | 14 000          | 16 000         | 27     | K 28×35×18    | G/SD 28×35×4                                  |
|                | 40             | 25 | 42,9               | 55             | 6,95               | 13 000          | 15 000         | 70     | K 28×40×25    | –                                             |
| 30             | 34             | 13 | 11,9               | 22             | 2,55               | 14 000          | 15 000         | 14     | K 30×34×13    | –                                             |
|                | 35             | 13 | 15,1               | 25,5           | 3                  | 13 000          | 15 000         | 14     | K 30×35×13    | –                                             |
|                | 35             | 17 | 18,7               | 34             | 4,05               | 13 000          | 15 000         | 19     | K 30×35×17    | –                                             |
|                | 35             | 27 | 29,2               | 60             | 7,35               | 13 000          | 15 000         | 30     | K 30×35×27    | –                                             |
|                | 37             | 16 | 22                 | 33,5           | 4                  | 13 000          | 15 000         | 27     | K 30×37×16    | G/SD 30×37×4                                  |
|                | 37             | 18 | 25,1               | 39             | 4,65               | 13 000          | 15 000         | 30     | K 30×37×18    | G/SD 30×37×4                                  |
|                | 40             | 18 | 30,3               | 40             | 4,9                | 12 000          | 14 000         | 48     | K 30×40×18    | G/SD 30×40×4                                  |
|                | 40             | 30 | 46,8               | 69,5           | 8,65               | 12 000          | 14 000         | 73     | K 30×40×30    | G/SD 30×40×4                                  |

<sup>1)</sup> For additional information, refer to the section *Radial shaft seals with a low cross sectional height*, starting on page 208.

## Needle roller and cage assemblies

F<sub>w</sub> 32 – 55 mm

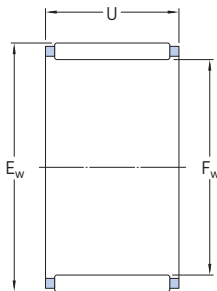

K

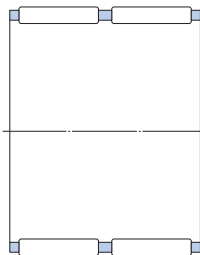

K..ZW

| Dimensions     |                |    | Basic load ratings |        | Fatigue load limit | Speed ratings   |                | Mass   | Designation     | Appropriate seal <sup>1)</sup><br>Designation |
|----------------|----------------|----|--------------------|--------|--------------------|-----------------|----------------|--------|-----------------|-----------------------------------------------|
| F <sub>w</sub> | E <sub>w</sub> | U  | dynamic            | static |                    | Reference speed | Limiting speed |        |                 |                                               |
| mm             |                |    | kN                 |        | kN                 | r/min           |                | g      | –               | –                                             |
| 32             | 37             | 13 | 14,7               | 25,5   | 3                  | 13 000          | 14 000         | 18     | K 32×37×13      | –                                             |
|                | 37             | 17 | 19                 | 35,5   | 4,25               | 13 000          | 14 000         | 19     | K 32×37×17      | –                                             |
|                | 37             | 27 | 28,6               | 60     | 7,35               | 13 000          | 14 000         | 30     | K 32×37×27      | –                                             |
|                | 38             | 20 | 25,1               | 45     | 5,6                | 12 000          | 14 000         | 30     | K 32×38×20      | –                                             |
|                | 39             | 16 | 22,9               | 35,5   | 4,25               | 12 000          | 14 000         | 37     | K 32×39×16      | –                                             |
|                | 39             | 18 | 25,5               | 41,5   | 5                  | 12 000          | 14 000         | 31     | K 32×39×18      | –                                             |
|                | 40             | 25 | 35,8               | 58,5   | 7,2                | 12 000          | 14 000         | 49     | K 32×40×25      | –                                             |
|                | 40             | 42 | 48,4               | 83     | 10,2               | 14 000          | 12 000         | 77     | K 32×40×42 ZWTN | –                                             |
|                | 46             | 32 | 62,7               | 83     | 10,4               | 11 000          | 13 000         | 119    | K 32×46×32      | –                                             |
| 35             | 40             | 13 | 15,4               | 28     | 3,25               | 12 000          | 13 000         | 19     | K 35×40×13      | –                                             |
|                | 40             | 17 | 19,8               | 39     | 4,65               | 12 000          | 13 000         | 21     | K 35×40×17      | –                                             |
|                | 40             | 25 | 28,1               | 60     | 7,35               | 12 000          | 13 000         | 31     | K 35×40×25      | –                                             |
|                | 40             | 27 | 23,8               | 49     | 6                  | 12 000          | 13 000         | 39     | K 35×40×27 TN   | –                                             |
|                | 42             | 16 | 23,3               | 37,5   | 4,5                | 11 000          | 13 000         | 34     | K 35×42×16      | G/SD 35×42×4                                  |
|                | 42             | 18 | 26,4               | 44     | 5,3                | 11 000          | 13 000         | 34     | K 35×42×18      | G/SD 35×42×4                                  |
|                | 42             | 20 | 29,2               | 50     | 6                  | 11 000          | 13 000         | 37     | K 35×42×20      | G/SD 35×42×4                                  |
|                | 42             | 30 | 37,4               | 68     | 8,5                | 11 000          | 13 000         | 67     | K 35×42×30      | G/SD 35×42×4                                  |
|                | 45             | 20 | 35,2               | 50     | 6,2                | 11 000          | 12 000         | 56     | K 35×45×20      | G/SD 35×45×4                                  |
|                | 45             | 30 | 50,1               | 80     | 10                 | 11 000          | 12 000         | 80     | K 35×45×30      | G/SD 35×45×4                                  |
|                | 37             | 42 | 17                 | 21,6   | 43                 | 5,2             | 11 000         | 13 000 | 22              | K 37×42×17                                    |
| 38             | 43             | 17 | 19,8               | 39     | 4,65               | 11 000          | 12 000         | 29     | K 38×43×17      | –                                             |
|                | 43             | 27 | 30,3               | 68     | 8,3                | 11 000          | 12 000         | 43     | K 38×43×27      | –                                             |
|                | 46             | 20 | 34,1               | 57     | 6,95               | 10 000          | 12 000         | 47     | K 38×46×20      | –                                             |
|                | 46             | 32 | 52,3               | 100    | 12,5               | 10 000          | 12 000         | 76     | K 38×46×32      | –                                             |
| 39             | 44             | 26 | 26                 | 57     | 6,7                | 10 000          | 12 000         | 45     | K 39×44×26 ZW   | –                                             |
| 40             | 45             | 13 | 16,8               | 32,5   | 3,8                | 10 000          | 12 000         | 22     | K 40×45×13      | –                                             |
|                | 45             | 17 | 20,5               | 41,5   | 5                  | 10 000          | 12 000         | 31     | K 40×45×17      | –                                             |
|                | 45             | 27 | 31,4               | 73,5   | 9                  | 10 000          | 12 000         | 46     | K 40×45×27      | –                                             |
|                | 47             | 18 | 28,6               | 50     | 6,1                | 10 000          | 11 000         | 39     | K 40×47×18      | G/SD 40×47×4                                  |
|                | 47             | 20 | 31,4               | 57     | 6,95               | 10 000          | 11 000         | 42     | K 40×47×20      | G/SD 40×47×4                                  |
|                | 48             | 20 | 34,7               | 58,5   | 7,35               | 10 000          | 11 000         | 49     | K 40×48×20      | –                                             |

<sup>1)</sup> For additional information, refer to the section *Radial shaft seals with a low cross sectional height*, starting on page 208.

| Dimensions     |                |      | Basic load ratings |                | Fatigue load limit | Speed ratings   |                | Mass  | Designation          | Appropriate seal <sup>1)</sup> |
|----------------|----------------|------|--------------------|----------------|--------------------|-----------------|----------------|-------|----------------------|--------------------------------|
| F <sub>w</sub> | E <sub>w</sub> | U    | C                  | C <sub>0</sub> | P <sub>u</sub>     | Reference speed | Limiting speed |       |                      | Designation                    |
| mm             |                |      | kN                 |                | kN                 | r/min           |                | g     | –                    | –                              |
| <b>42</b>      | 47             | 13   | 17,2               | 33,5           | 4                  | 10 000          | 11 000         | 18    | <b>K 42×47×13</b>    | –                              |
|                | 47             | 17   | 20,9               | 43             | 5,2                | 10 000          | 11 000         | 32    | <b>K 42×47×17</b>    | –                              |
|                | 47             | 30   | 31,9               | 76,5           | 9                  | 10 000          | 11 000         | 54    | <b>K 42×47×30 ZW</b> | –                              |
|                | 50             | 20   | 31,9               | 54             | 7,2                | 9 500           | 11 000         | 53    | <b>K 42×50×20</b>    | –                              |
| <b>43</b>      | 48             | 17   | 20,9               | 43             | 5,2                | 9 500           | 11 000         | 30    | <b>K 43×48×17</b>    | –                              |
|                | 48             | 27   | 31,9               | 76,5           | 9,3                | 9 500           | 11 000         | 50    | <b>K 43×48×27</b>    | –                              |
| <b>45</b>      | 50             | 17   | 21,6               | 46,5           | 5,6                | 9 000           | 10 000         | 34    | <b>K 45×50×17</b>    | –                              |
|                | 50             | 27   | 33                 | 81,5           | 10                 | 9 000           | 10 000         | 51    | <b>K 45×50×27</b>    | –                              |
|                | 52             | 18   | 30,3               | 57             | 6,95               | 9 000           | 10 000         | 42    | <b>K 45×52×18</b>    | G/SD 45×52×4                   |
|                | 53             | 20   | 37,4               | 68             | 8,3                | 9 000           | 10 000         | 55    | <b>K 45×53×20</b>    | –                              |
|                | 53             | 21   | 36,9               | 67             | 8,3                | 9 000           | 10 000         | 60    | <b>K 45×53×21</b>    | –                              |
|                | 53             | 28   | 49,5               | 98             | 12,2               | 9 000           | 10 000         | 81    | <b>K 45×53×28</b>    | –                              |
|                | 59             | 18   | 44                 | 53             | 6,55               | 8 500           | 9 500          | 72    | <b>K 45×53×18 TN</b> | –                              |
|                | 59             | 32   | 69,3               | 102            | 12,9               | 8 500           | 9 500          | 148   | <b>K 45×59×32</b>    | –                              |
| <b>47</b>      | 52             | 17   | 22,4               | 49             | 6                  | 9 000           | 10 000         | 35    | <b>K 47×52×17</b>    | –                              |
|                | 52             | 27   | 33,6               | 83             | 10,2               | 9 000           | 10 000         | 51    | <b>K 47×52×27</b>    | –                              |
| <b>50</b>      | 55             | 13,5 | 17,6               | 36,5           | 4,3                | 8 500           | 9 500          | 30    | <b>K 50×55×13.5</b>  | –                              |
|                | 55             | 17   | 21,2               | 47,5           | 5,7                | 8 500           | 9 500          | 35    | <b>K 50×55×17</b>    | –                              |
|                | 55             | 20   | 25,5               | 60             | 7,2                | 8 500           | 9 500          | 43    | <b>K 50×55×20</b>    | –                              |
|                | 55             | 30   | 37,4               | 98             | 12                 | 8 500           | 9 500          | 65    | <b>K 50×55×30</b>    | –                              |
|                | 57             | 18   | 31,9               | 64             | 7,8                | 8 000           | 9 000          | 47    | <b>K 50×57×18</b>    | –                              |
|                | 58             | 20   | 34,1               | 62             | 7,65               | 8 000           | 9 000          | 75    | <b>K 50×58×20</b>    | G/SD 50×58×4                   |
|                | 58             | 25   | 41,8               | 81,5           | 10,2               | 8 000           | 9 000          | 90    | <b>K 50×58×25</b>    | G/SD 50×58×4                   |
|                | <b>52</b>      | 57   | 12                 | 17,2           | 36,5               | 4,3             | 8 000          | 9 000 | 24                   | <b>K 52×57×12</b>              |
| <b>55</b>      | 60             | 20   | 27                 | 67             | 8,15               | 7 500           | 8 500          | 40    | <b>K 55×60×20</b>    | –                              |
|                | 60             | 27   | 35,8               | 96,5           | 12                 | 7 500           | 8 500          | 60    | <b>K 55×60×27</b>    | –                              |
|                | 60             | 30   | 39,6               | 108            | 13,4               | 7 500           | 8 500          | 71    | <b>K 55×60×30</b>    | –                              |
|                | 62             | 18   | 34,1               | 71             | 8,5                | 7 500           | 8 500          | 52    | <b>K 55×62×18</b>    | –                              |
|                | 63             | 20   | 38                 | 75             | 9,15               | 7 500           | 8 500          | 67    | <b>K 55×63×20</b>    | G 55×63×5                      |
|                | 63             | 25   | 48,4               | 102            | 12,7               | 7 500           | 8 500          | 80    | <b>K 55×63×25</b>    | G 55×63×5                      |
|                | 63             | 32   | 59,4               | 129            | 16,3               | 7 500           | 8 500          | 100   | <b>K 55×63×32</b>    | G 55×63×5                      |

<sup>1)</sup> For additional information, refer to the section *Radial shaft seals with a low cross sectional height*, starting on **page 208**.

## Needle roller and cage assemblies

$F_w$  58 – 155 mm

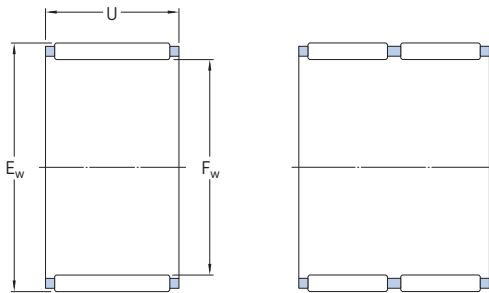

K

K..ZW

| Dimensions |       |    | Basic load ratings |        | Fatigue load limit | Speed ratings   |                | Mass | Designation   | Appropriate seal <sup>1)</sup><br>Designation |
|------------|-------|----|--------------------|--------|--------------------|-----------------|----------------|------|---------------|-----------------------------------------------|
| $F_w$      | $E_w$ | U  | dynamic            | static |                    | Reference speed | Limiting speed |      |               |                                               |
| mm         |       |    | kN                 |        | kN                 | r/min           |                | g    | –             | –                                             |
| 58         | 65    | 18 | 33,6               | 71     | 8,65               | 7 000           | 8 000          | 52   | K 58×65×18    | –                                             |
|            | 65    | 36 | 47,3               | 108    | 12,9               | 7 000           | 8 000          | 130  | K 58×65×36 ZW | –                                             |
| 60         | 65    | 20 | 28,1               | 72     | 8,8                | 7 000           | 8 000          | 52   | K 60×65×20    | –                                             |
|            | 65    | 30 | 41,3               | 116    | 14,3               | 7 000           | 8 000          | 77   | K 60×65×30    | –                                             |
|            | 66    | 33 | 44                 | 112    | 13,7               | 7 000           | 8 000          | 100  | K 60×66×33 ZW | –                                             |
|            | 66    | 40 | 55                 | 150    | 18,6               | 7 000           | 8 000          | 120  | K 60×66×40 ZW | –                                             |
|            | 68    | 20 | 41,8               | 86,5   | 10,6               | 6 700           | 7 500          | 71   | K 60×68×20    | –                                             |
|            | 68    | 23 | 47,3               | 102    | 12,5               | 6 700           | 7 500          | 94   | K 60×68×23    | –                                             |
|            | 68    | 25 | 51,2               | 112    | 14                 | 6 700           | 7 500          | 89   | K 60×68×25    | –                                             |
|            | 68    | 30 | 42,9               | 88     | 10,6               | 6 700           | 7 500          | 130  | K 60×68×30 ZW | –                                             |
|            | 75    | 42 | 112                | 196    | 25                 | 6 300           | 7 500          | 240  | K 60×75×42    | –                                             |
| 62         | 70    | 40 | 62,7               | 146    | 18,6               | 6 700           | 7 500          | 170  | K 62×70×40 ZW | –                                             |
| 64         | 70    | 16 | 26,4               | 60     | 7,35               | 6 300           | 7 500          | 53   | K 64×70×16    | –                                             |
| 65         | 70    | 20 | 29,2               | 76,5   | 9,3                | 6 300           | 7 500          | 56   | K 65×70×20    | –                                             |
|            | 70    | 30 | 41,8               | 125    | 15,3               | 6 300           | 7 500          | 83   | K 65×70×30    | –                                             |
|            | 73    | 23 | 41,8               | 90     | 11,8               | 6 300           | 7 000          | 110  | K 65×73×23    | –                                             |
|            | 73    | 30 | 53,9               | 125    | 15,6               | 6 300           | 7 000          | 140  | K 65×73×30    | –                                             |
| 68         | 74    | 20 | 33,6               | 83     | 10,4               | 6 000           | 7 000          | 71   | K 68×74×20    | –                                             |
|            | 74    | 30 | 44,6               | 118    | 15                 | 6 000           | 7 000          | 100  | K 68×74×30    | –                                             |
|            | 74    | 35 | 46,8               | 125    | 15,3               | 7 000           | 6 000          | 120  | K 68×74×35 ZW | –                                             |
| 70         | 76    | 20 | 34,1               | 86,5   | 10,6               | 6 000           | 6 700          | 71   | K 70×76×20    | –                                             |
|            | 76    | 30 | 50,1               | 140    | 17,6               | 6 000           | 6 700          | 110  | K 70×76×30    | –                                             |
|            | 78    | 30 | 57,2               | 137    | 17                 | 6 000           | 6 700          | 150  | K 70×78×30    | G 70×78×5                                     |
| 72         | 80    | 20 | 39,6               | 85     | 10,6               | 5 600           | 6 300          | 98   | K 72×80×20    | –                                             |
| 73         | 79    | 20 | 35,2               | 90     | 11,2               | 5 600           | 6 300          | 75   | K 73×79×20    | –                                             |
| 75         | 81    | 20 | 35,8               | 93     | 11,6               | 5 600           | 6 300          | 79   | K 75×81×20    | –                                             |
|            | 81    | 30 | 50,1               | 143    | 18                 | 5 600           | 6 300          | 110  | K 75×81×30    | –                                             |
|            | 83    | 23 | 47,3               | 110    | 13,7               | 5 300           | 6 300          | 120  | K 75×83×23    | –                                             |
|            | 83    | 30 | 59,4               | 143    | 18                 | 5 300           | 6 300          | 150  | K 75×83×30    | –                                             |
|            | 83    | 35 | 60,5               | 146    | 18                 | 6 300           | 5 300          | 182  | K 75×83×35 ZW | –                                             |
|            | 83    | 40 | 69,3               | 176    | 22                 | 6 300           | 5 300          | 211  | K 75×83×40 ZW | –                                             |

<sup>1)</sup> For additional information, refer to the section *Radial shaft seals with a low cross sectional height*, starting on page 208.



| Dimensions |       |    | Basic load ratings |                 | Fatigue load limit<br>$P_u$ | Speed ratings   |                | Mass<br>g | Designation           |
|------------|-------|----|--------------------|-----------------|-----------------------------|-----------------|----------------|-----------|-----------------------|
| $F_w$      | $E_w$ | U  | dynamic<br>C       | static<br>$C_0$ |                             | Reference speed | Limiting speed |           |                       |
| mm         |       |    | kN                 |                 | kN                          | r/min           |                |           | -                     |
| <b>80</b>  | 86    | 20 | 36,9               | 98              | 12,2                        | 5 300           | 6 000          | 60        | <b>K 80×86×20</b>     |
|            | 88    | 30 | 68,2               | 176             | 22                          | 5 000           | 6 000          | 140       | <b>K 80×88×30</b>     |
|            | 88    | 40 | 72,1               | 193             | 23,6                        | 6 000           | 5 000          | 227       | <b>K 80×88×40 ZW</b>  |
|            | 88    | 46 | 84,2               | 232             | 28,5                        | 6 000           | 5 000          | 260       | <b>K 80×88×46 ZW</b>  |
| <b>85</b>  | 92    | 20 | 42,9               | 108             | 13,2                        | 4 800           | 5 600          | 100       | <b>K 85×92×20</b>     |
| <b>90</b>  | 97    | 20 | 42,9               | 114             | 13,7                        | 4 500           | 5 300          | 110       | <b>K 90×97×20</b>     |
|            | 98    | 27 | 58,3               | 150             | 18,6                        | 4 500           | 5 300          | 150       | <b>K 90×98×27</b>     |
|            | 98    | 30 | 64,4               | 173             | 21,6                        | 4 500           | 5 300          | 170       | <b>K 90×98×30</b>     |
| <b>95</b>  | 103   | 30 | 66                 | 180             | 22,8                        | 4 300           | 5 000          | 170       | <b>K 95×103×30</b>    |
|            | 103   | 40 | 79,2               | 228             | 28,5                        | 5 000           | 4 300          | 266       | <b>K 95×103×40 ZW</b> |
| <b>100</b> | 107   | 21 | 45,7               | 127             | 15,3                        | 4 000           | 4 800          | 120       | <b>K 100×107×21</b>   |
|            | 108   | 27 | 55                 | 143             | 17,6                        | 4 000           | 4 800          | 190       | <b>K 100×108×27</b>   |
|            | 108   | 30 | 67,1               | 190             | 23,6                        | 4 000           | 4 800          | 180       | <b>K 100×108×30</b>   |
| <b>105</b> | 112   | 21 | 45,7               | 129             | 15,3                        | 4 000           | 4 500          | 130       | <b>K 105×112×21</b>   |
| <b>110</b> | 117   | 24 | 53,9               | 160             | 18,6                        | 3 800           | 4 300          | 170       | <b>K 110×117×24</b>   |
|            | 118   | 30 | 73,7               | 220             | 26,5                        | 3 800           | 4 300          | 220       | <b>K 110×118×30</b>   |
| <b>115</b> | 123   | 27 | 60,5               | 170             | 20                          | 3 600           | 4 000          | 200       | <b>K 115×123×27</b>   |
| <b>120</b> | 127   | 24 | 56,1               | 176             | 20,4                        | 3 400           | 4 000          | 170       | <b>K 120×127×24</b>   |
| <b>125</b> | 133   | 35 | 82,5               | 260             | 30,5                        | 3 200           | 3 800          | 280       | <b>K 125×133×35</b>   |
| <b>130</b> | 137   | 24 | 58,3               | 186             | 21,2                        | 3 200           | 3 600          | 170       | <b>K 130×137×24</b>   |
| <b>135</b> | 143   | 35 | 88                 | 290             | 33,5                        | 3 000           | 3 400          | 300       | <b>K 135×143×35</b>   |
| <b>145</b> | 153   | 26 | 70,4               | 224             | 25                          | 2 800           | 3 200          | 260       | <b>K 145×153×26</b>   |
| <b>150</b> | 160   | 46 | 140                | 475             | 53                          | 2 800           | 3 000          | 570       | <b>K 150×160×46</b>   |
| <b>155</b> | 163   | 26 | 72,1               | 236             | 25,5                        | 2 600           | 3 000          | 270       | <b>K 155×163×26</b>   |

## Needle roller and cage assemblies

$F_w$  160 – 265 mm

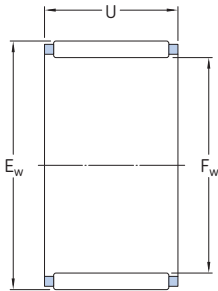

K

| Dimensions |       |    | Basic load ratings |        | Fatigue load limit | Speed ratings   |                | Mass  | Designation         |
|------------|-------|----|--------------------|--------|--------------------|-----------------|----------------|-------|---------------------|
| $F_w$      | $E_w$ | U  | dynamic            | static |                    | Reference speed | Limiting speed |       |                     |
|            |       |    | C                  | $C_0$  | $P_u$              |                 |                |       |                     |
| mm         |       |    | kN                 |        | kN                 | r/min           |                | g     | –                   |
| <b>160</b> | 170   | 46 | 145                | 510    | 56                 | 2 600           | 2 800          | 550   | <b>K 160×170×46</b> |
| <b>165</b> | 173   | 26 | 76,5               | 265    | 28,5               | 2 400           | 2 800          | 320   | <b>K 165×173×26</b> |
| <b>175</b> | 183   | 32 | 95,2               | 355    | 37,5               | 2 400           | 2 600          | 400   | <b>K 175×183×32</b> |
| <b>185</b> | 195   | 37 | 123                | 425    | 45                 | 2 200           | 2 400          | 610   | <b>K 185×195×37</b> |
| <b>195</b> | 205   | 37 | 125                | 450    | 46,5               | 2 000           | 2 400          | 620   | <b>K 195×205×37</b> |
| <b>210</b> | 220   | 42 | 147                | 560    | 57                 | 1 900           | 2 200          | 740   | <b>K 210×220×42</b> |
| <b>220</b> | 230   | 42 | 151                | 585    | 58,5               | 1 800           | 2 000          | 790   | <b>K 220×230×42</b> |
| <b>240</b> | 250   | 42 | 157                | 630    | 62                 | 1 700           | 1 900          | 850   | <b>K 240×250×42</b> |
| <b>265</b> | 280   | 50 | 242                | 850    | 83                 | 1 500           | 1 700          | 1 800 | <b>K 265×280×50</b> |





# Drawn cup needle roller bearings

|                                                       |    |
|-------------------------------------------------------|----|
| Sealed drawn cup needle roller bearings .....         | 78 |
| Full complement drawn cup needle roller bearings..... | 79 |
| Dimensions.....                                       | 79 |
| Tolerances .....                                      | 79 |
| Misalignment.....                                     | 80 |
| Cages .....                                           | 80 |
| Shaft and housing tolerances .....                    | 80 |
| Operational clearance.....                            | 80 |
| Mounting instructions .....                           | 81 |
| Static safety factor .....                            | 81 |
| Supplementary designations.....                       | 81 |
| Product tables .....                                  | 82 |
| 3.1 Drawn cup needle roller bearings.....             | 82 |



## Drawn cup needle roller bearings

Drawn cup needle roller bearings, as the name suggests, are needle roller bearings with a deep drawn, thin-walled outer ring with either open ends or a closed end. They are characterized by a very low sectional height and high load carrying capacity. Drawn cup needle roller bearings are typically used in applications where the housing bore cannot be used as a raceway for a needle roller and cage assembly, but where a very compact and economical bearing arrangement is required.

Generally, drawn cup needle roller bearings have a recommended maximum operating temperature of 140 °C, unless otherwise stated in the relevant sections in this chapter. The maximum operating temperature is limited by the seal and cage materials and the applied grease.

SKF supplies a wide assortment of drawn cup needle roller bearings. This includes:

- drawn cup needle roller bearings with open ends (→ **fig. 1**)
- drawn cup needle roller bearings with a closed end (→ **fig. 2**)
- full complement drawn cup needle roller bearings with open ends (→ **fig. 3**)

Drawn cup needle roller bearings with a closed end are suitable for bearing arrangements at the ends of shafts. The profiled design of the closed end accommodates small axial guidance forces. Drawn cup needle roller bearings generally run directly on the shaft. However, in cases where the shaft cannot be hardened and ground, they can be combined with an inner ring (→ **fig. 4**).

The drawn cup of hardened steel and the needle roller and cage assembly of these bearings form a non-separable unit. The space available for lubricant is large enough to enable long relubrication intervals.

Typically, drawn cup needle roller bearings have a single row of rollers. However, wide sizes incorporate two needle roller and cage assemblies immediately adjacent to each other with a lubrication hole in the outer ring (→ **fig. 5**).

On request, any single row drawn cup needle roller bearing for shaft diameters of 7 mm and above can be supplied with a lubrication hole in the outer ring (→ **fig. 6**).

Fig. 1

Drawn cup needle roller bearing with open ends

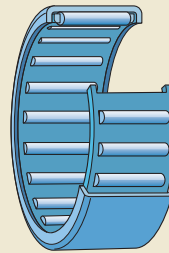

HK series

Fig. 2

Drawn cup needle roller bearing with a closed end

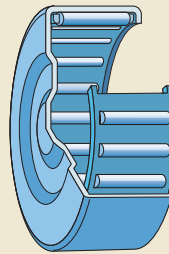

BK series

Fig. 3

Full complement drawn cup needle roller bearing with open ends

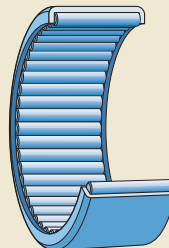

HN series

Fig. 4

Drawn cup needle roller bearing combined with an inner ring and an external seal

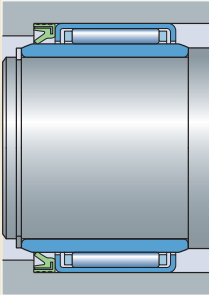

Fig. 7

Drawn cup needle roller bearing combined with a needle roller thrust bearing, AXW series

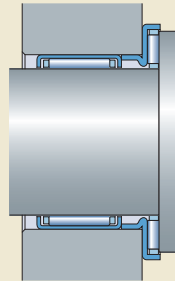

Fig. 5

Wide size drawn cup needle roller bearing, double row, with a lubrication hole

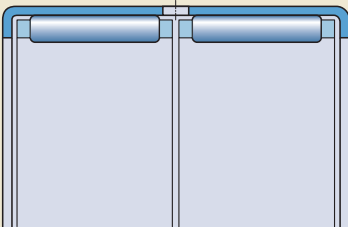
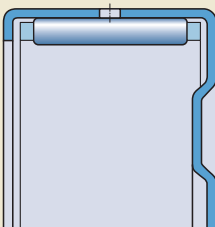

Fig. 6

Drawn cup needle roller bearing with a closed end and lubrication hole



Drawn cup needle roller bearings are mounted with an interference fit in the housing bore. Therefore, shoulders or snap rings are not required to locate the bearing axially so the design of the housing bore is simple and can be produced economically.

To accommodate combined radial and axial loads (→ **fig. 7**), drawn cup needle roller bearings of certain sizes can be combined with a needle roller thrust bearing with a centring spigot, AXW series.

### Sealed drawn cup needle roller bearings

For applications where a sufficiently efficient seal is not available, or cannot be used for space reasons, drawn cup needle roller bearings can also be supplied with integral lip seals. These include:

- drawn cup needle roller bearings with open ends, sealed on one side, designation suffix RS (→ **fig. 8**), available for shaft diameters ranging from 8 mm to 50 mm
- drawn cup needle roller bearings with open ends, sealed on both sides, designation suffix .2RS (→ **fig. 9**), available for shaft diameters ranging from 8 mm to 50 mm
- sealed drawn cup needle roller bearings with a closed end, designation suffix RS (→ **fig. 10**), available for shaft diameters ranging from 10 mm to 25 mm

The integral seals are contact seals made of polyurethane (AU), fluoro rubber (FKM) or acrylonitrile-butadiene rubber (NBR). The use of a sealed drawn cup needle roller bearing is, under normal conditions, an extremely cost-effective solution to exclude solid contaminants and moisture and retain the lubricant in the bearing. The permissible operating temperature range for sealed bearings is  $-30$  to  $+100$  °C.

#### Initial grease fill and relubrication

Sealed drawn cup needle roller bearings are filled at the factory with a high-quality grease that has good corrosion inhibiting properties. The relatively large quantity of grease in the bearings means they can be operated for long periods before relubrication is required. SKF recommends using SKF LGWA 2 grease for relubrication.

For additional information about greases, refer to the section *Lubrication*, starting on **page 52** and **table 1** on **page 54**.

Fig. 8

Drawn cup needle roller bearing with open ends, sealed on one side

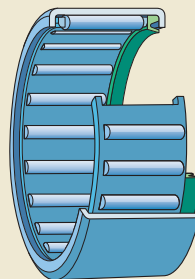

HK .. RS series

Fig. 9

Drawn cup needle roller bearing with open ends, sealed on both sides

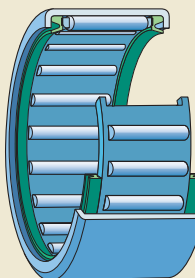

HK ...2RS series

Fig. 10

Sealed drawn cup needle roller bearing with a closed end

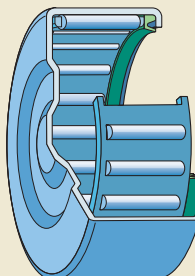

BK .. RS series



# Full complement drawn cup needle roller bearings

Full complement drawn cup needle roller bearings with open ends (→ **fig. 3, page 76**) are suitable for very heavy radial loads at moderate speeds.

## Initial grease fill and relubrication

A special grease is used to secure the rollers during transportation, however, this grease does not provide sufficient long term lubrication. Therefore, relubrication after mounting may be necessary. Depending on the required consistency class, SKF recommends SKF LGEP 2 or SKF LGMW 1 grease for relubrication. For additional information and characteristics (→ **table 2, page 54**) of the initial grease fill and the greases for relubrication, refer to the section *Lubrication*, starting on **page 52** or contact the SKF application engineering service.

## Dimensions

The boundary dimensions of drawn cup needle roller bearings are in accordance with ISO 3245:2007, as far as they have been standardized.

## Tolerances

The dimensional accuracy of drawn cup needle roller bearings cannot be checked until they have been mounted, because the thin-walled outer ring may be slightly out-of-round. Only after the bearing has been pressed into a housing bore that is machined to the recommended tolerance classes can the outer ring obtain its correct form, which is crucial for bearing performance. To check the inside diameter  $F_w$  of the roller set, the bearing must first be pressed into a thick-walled gauge ring with a bore diameter as listed in **table 1**. A measuring mandrel can then be used to check the inside diameter deviation. The permissible deviations are also listed in the table.

The tolerance values listed are in accordance with ISO 3245:2007, as far as they have been standardized.

Table 1

Tolerances for drawn cup needle roller bearings

| Bearing<br>Inside<br>diameter<br>$F_w$ | Outside<br>diameter<br>D | Gauge ring<br>Bore<br>diameter<br>(measured) | Deviations from<br>nominal inside<br>diameter |     |
|----------------------------------------|--------------------------|----------------------------------------------|-----------------------------------------------|-----|
|                                        |                          |                                              | high                                          | low |
| mm                                     |                          | mm                                           | µm                                            |     |
| 3                                      | 6,5                      | 6,484                                        | +24                                           | +6  |
| 4                                      | 8                        | 7,984                                        | +28                                           | +10 |
| 5                                      | 9                        | 8,984                                        | +28                                           | +10 |
| 6                                      | 10                       | 9,984                                        | +28                                           | +10 |
| 7                                      | 11                       | 10,980                                       | +31                                           | +13 |
| 8                                      | 12                       | 11,980                                       | +31                                           | +13 |
| 9                                      | 13                       | 12,980                                       | +31                                           | +13 |
| 10                                     | 14                       | 13,980                                       | +31                                           | +13 |
| 12                                     | 16                       | 15,980                                       | +34                                           | +16 |
| 12                                     | 18                       | 17,980                                       | +34                                           | +16 |
| 13                                     | 19                       | 18,976                                       | +34                                           | +16 |
| 14                                     | 20                       | 19,976                                       | +34                                           | +16 |
| 15                                     | 21                       | 20,976                                       | +34                                           | +16 |
| 16                                     | 22                       | 21,976                                       | +34                                           | +16 |
| 17                                     | 23                       | 22,976                                       | +34                                           | +16 |
| 18                                     | 24                       | 23,976                                       | +34                                           | +16 |
| 20                                     | 26                       | 25,976                                       | +41                                           | +20 |
| 22                                     | 28                       | 27,976                                       | +41                                           | +20 |
| 25                                     | 32                       | 31,972                                       | +41                                           | +20 |
| 28                                     | 35                       | 34,972                                       | +41                                           | +20 |
| 30                                     | 37                       | 36,972                                       | +41                                           | +20 |
| 32                                     | 39                       | 38,972                                       | +50                                           | +25 |
| 35                                     | 42                       | 41,972                                       | +50                                           | +25 |
| 40                                     | 47                       | 46,972                                       | +50                                           | +25 |
| 45                                     | 52                       | 51,967                                       | +50                                           | +25 |
| 50                                     | 58                       | 57,967                                       | +50                                           | +25 |
| 55                                     | 63                       | 62,967                                       | +60                                           | +30 |
| 60                                     | 68                       | 67,967                                       | +60                                           | +30 |

The width tolerance is 0/-0,3 mm for all drawn cup needle roller bearing sizes.

## Paired mounting

If drawn cup needle roller bearings are to be mounted immediately adjacent to each other, the deviations from the nominal internal diameter must be the same for both bearings if they are to share the load equally.

# Misalignment

The ends of the needle rollers are relieved slightly to modify the line contact between the raceways and the rollers. This provides favourable load distribution in the bearing and minimizes damaging edge stresses. It also enables single row drawn cup needle roller bearings to accommodate a small amount of misalignment, approximately 1 min of arc between the shaft and housing.

The detrimental effects of misalignment increase with increasing bearing width and load. For additional information, contact the SKF application engineering service.

# Cages

SKF drawn cup needle roller bearings are fitted, as standard, with a sheet steel cage (→ **fig. 11**), except for those identified by the designation suffix TN. These have an injection moulded, glass fibre reinforced polyamide 66 cage (→ **fig. 12**).

### Note

Drawn cup needle roller bearings with a polyamide 66 cage can be operated at temperatures up to +120 °C. The lubricants generally used for rolling bearings do not have a detrimental effect on cage properties. Exceptions are a few synthetic oils and greases with a synthetic oil base and lubricants containing a high proportion of EP additives when used at high temperatures.

For bearing arrangements that will operate at continuously high temperatures or under arduous conditions, SKF recommends using bearings with a steel cage.

For detailed information about the temperature resistance and the applicability of cages, refer to the section *Cage materials*, starting on **page 44**.

# Shaft and housing tolerances

Drawn cup needle roller bearings need a housing bore that has a good dimensional form and accuracy. For these bearings, to obtain the necessary interference fit in the housing, the tolerance classes listed in **table 2** must be

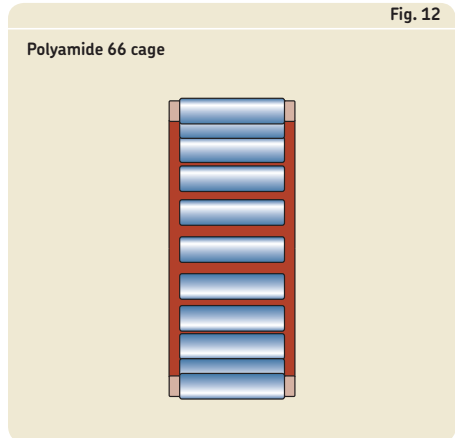
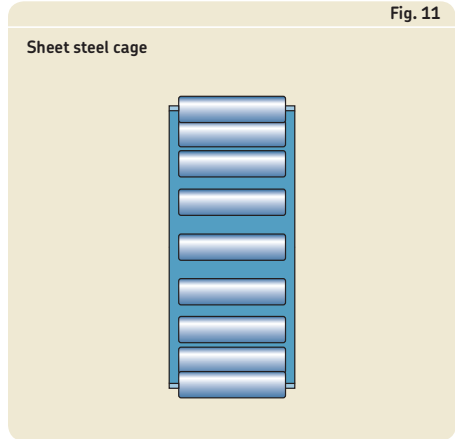

applied. The cylindricity of the housing bore should be within IT5/2 tolerance grade and the shaft raceway should be within IT3 tolerance grade.

# Operational clearance

When the recommended tolerance classes are applied, the inside diameter  $F_w$  (diameter under the rollers) will be approximately within F8 tolerance class. This, together with the recommended shaft tolerance class, which is also listed in **table 2**, will reach a suitable (medium) operational clearance in the range of C2 to C3 radial internal clearance. The clearance value depends on the shaft diameter, the operating

temperature, and on the raceway diameter when combined with an inner ring.

## Mounting instructions

Drawn cup needle roller bearings should be mounted with a heavy interference fit in the housing bore. Therefore, SKF recommends mounting them using a mounting dolly (→ fig. 13). An O-ring provides a simple means of retaining the bearing on the mounting dolly. The stamped side face of drawn cup needle roller bearings should preferably abut the flange of the mounting dolly.

If grease lubrication is going to be used, the bearing should be lubricated before mounting.

### Note

Special care should be taken to prevent the bearings from skewing or tilting when they are being pressed into the housing. Otherwise the rollers and raceways could easily be damaged.

## Static safety factor

SKF recommends applying a static safety factor of 3 or larger, i.e.  $s_0 = C_0/P_0 \geq 3$ .

## Supplementary designations

The designation suffixes used to identify certain features of SKF drawn cup needle roller bearings are explained in the following.

- AS1** One lubrication hole in the outer ring
- H..** Needle roller bearing without an inner ring, with reduced inside diameter (under rollers) tolerance, followed by tolerance limits in  $\mu\text{m}$ , e.g. H+27+20
- RS** Contact seal on one side of the bearing
- .2RS** Contact seal on both sides of a drawn cup needle roller bearing with open ends
- TN** Injection moulded cage of glass fibre reinforced polyamide 66

Table 2

### Shaft and housing tolerance classes

| Housing material <sup>1)</sup> | Tolerance classes               |                      |                       |
|--------------------------------|---------------------------------|----------------------|-----------------------|
|                                | Housing bore seat <sup>2)</sup> | Raceway on the shaft | Shaft inner ring seat |
| Steel, cast iron               | N6<br>N7                        | h5<br>h6             | k5<br>j6              |
| Light alloy                    | R6<br>R7                        | h5<br>h6             | k5<br>j6              |

<sup>1)</sup> For housings that are not rigid, the shaft tolerance giving the desired operational clearance must be determined by trial and error.

<sup>2)</sup> The accuracy of cylindrical form to ISO 1101-2004 for the housing bore must correspond to IT5/2 tolerance grade.

3

Fig. 13

### Mounting dolly

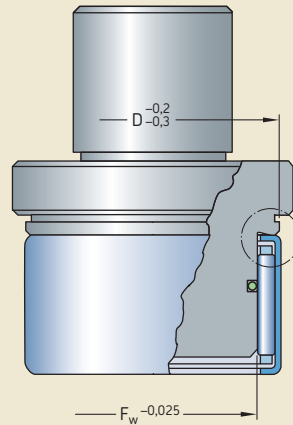

# Drawn cup needle roller bearings

$F_w$  3 – 9 mm

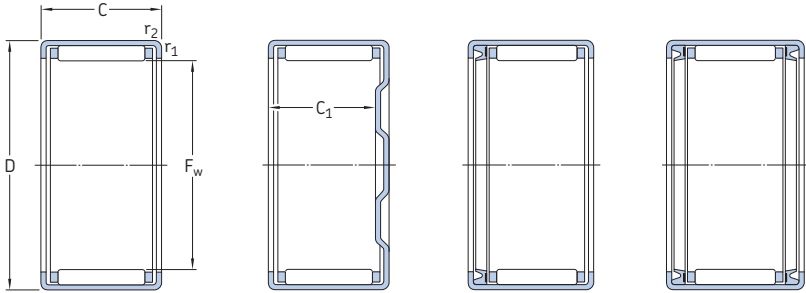

HK

BK

HK..RS

HK...2RS

| Principal dimensions |     |    | Basic load ratings |       | Fatigue load limit | Speed ratings   |                | Mass   | Designation |
|----------------------|-----|----|--------------------|-------|--------------------|-----------------|----------------|--------|-------------|
| $F_w$                | D   | C  | C                  | $C_0$ | $P_u$              | Reference speed | Limiting speed |        |             |
| mm                   |     |    | kN                 |       | kN                 | r/min           |                | kg     | –           |
| 3                    | 6,5 | 6  | 1,23               | 0,88  | 0,088              | 24 000          | 26 000         | 0,0010 | HK 0306 TN  |
|                      | 6,5 | 6  | 1,23               | 0,88  | 0,088              | 24 000          | 26 000         | 0,0010 | BK 0306 TN  |
| 4                    | 8   | 8  | 1,76               | 1,37  | 0,14               | 22 000          | 26 000         | 0,0020 | HK 0408     |
|                      | 8   | 8  | 1,76               | 1,37  | 0,14               | 22 000          | 26 000         | 0,0021 | BK 0408     |
| 5                    | 9   | 9  | 2,38               | 2,08  | 0,22               | 22 000          | 24 000         | 0,0020 | HK 0509     |
|                      | 9   | 9  | 2,38               | 2,08  | 0,22               | 22 000          | 24 000         | 0,0021 | BK 0509     |
| 6                    | 10  | 6  | 1,72               | 1,29  | 0,132              | 22 000          | 20 000         | 0,0015 | HK 0606     |
|                      | 10  | 8  | 2,01               | 1,73  | 0,18               | 20 000          | 22 000         | 0,0021 | HK 0608     |
|                      | 10  | 9  | 2,81               | 2,7   | 0,285              | 20 000          | 22 000         | 0,0025 | HK 0609     |
|                      | 10  | 9  | 2,81               | 2,7   | 0,285              | 20 000          | 22 000         | 0,0026 | BK 0609     |
| 7                    | 11  | 9  | 3,03               | 3,05  | 0,325              | 20 000          | 22 000         | 0,0026 | HK 0709     |
|                      | 11  | 9  | 3,03               | 3,05  | 0,325              | 20 000          | 22 000         | 0,0029 | BK 0709     |
| 8                    | 12  | 8  | 2,7                | 2,75  | 0,285              | 19 000          | 22 000         | 0,0027 | HK 0808     |
|                      | 12  | 8  | 2,7                | 2,75  | 0,285              | 19 000          | 22 000         | 0,0030 | BK 0808     |
|                      | 12  | 10 | 3,69               | 4,05  | 0,44               | 19 000          | 22 000         | 0,0030 | HK 0810     |
|                      | 12  | 10 | 2,7                | 2,75  | 0,285              | 19 000          | 13 000         | 0,0030 | HK 0810 RS  |
|                      | 12  | 10 | 2,3                | 2,04  | 0,208              | 13 000          | 19 000         | 0,0032 | HK 0810.2RS |
|                      | 12  | 10 | 3,69               | 4,05  | 0,44               | 19 000          | 22 000         | 0,0034 | BK 0810     |
|                      | 12  | 12 | 3,69               | 4,05  | 0,44               | 13 000          | 19 000         | 0,0031 | HK 0812 RS  |
|                      | 12  | 12 | 2,7                | 2,75  | 0,285              | –               | 13 000         | 0,0033 | HK 0812.2RS |
| 9                    | 13  | 8  | 3,52               | 3,9   | 0,415              | 20 000          | 20 000         | 0,0030 | HK 0908     |
|                      | 13  | 10 | 4,13               | 4,8   | 0,53               | 18 000          | 20 000         | 0,0040 | HK 0910     |
|                      | 13  | 10 | 4,13               | 4,8   | 0,53               | 18 000          | 20 000         | 0,0043 | BK 0910     |
|                      | 13  | 12 | 5,12               | 6,4   | 0,72               | 18 000          | 20 000         | 0,0046 | HK 0912     |
|                      | 13  | 12 | 5,12               | 6,4   | 0,72               | 18 000          | 20 000         | 0,0049 | BK 0912     |

| Dimensions     |                    |                      | Appropriate inner ring <sup>1)</sup> Designation | Appropriate seal <sup>2)</sup> Designation |
|----------------|--------------------|----------------------|--------------------------------------------------|--------------------------------------------|
| F <sub>w</sub> | C <sub>1</sub> min | r <sub>1,2</sub> min |                                                  |                                            |
| mm             |                    |                      |                                                  |                                            |
| 3              | –                  | 0,3                  | –                                                | –                                          |
|                | 5,2                | 0,3                  | –                                                | –                                          |
| 4              | –                  | 0,3                  | –                                                | G 4×8×2 S                                  |
|                | 6,4                | 0,3                  | –                                                | G 4×8×2 S                                  |
| 5              | –                  | 0,4                  | –                                                | G 5×9×2 S                                  |
|                | 7,2                | 0,4                  | –                                                | G 5×9×2 S                                  |
| 6              | –                  | 0,4                  | –                                                | G 6×10×2 S                                 |
|                | –                  | 0,4                  | –                                                | G 6×10×2 S                                 |
|                | –                  | 0,4                  | –                                                | G 6×10×2 S                                 |
|                | 7,4                | 0,4                  | –                                                | G 6×10×2 S                                 |
| 7              | –                  | 0,4                  | –                                                | G 7×11×2 S                                 |
|                | 7,4                | 0,4                  | –                                                | G 7×11×2 S                                 |
| 8              | –                  | 0,4                  | –                                                | G 8×12×3                                   |
|                | 6,4                | 0,4                  | –                                                | G 8×12×3                                   |
|                | –                  | 0,4                  | IR 5×8×12                                        | G 8×12×3                                   |
|                | –                  | 0,4                  | IR 5×8×12                                        | –                                          |
|                | –                  | 0,4                  | –                                                | –                                          |
|                | 8,4                | 0,4                  | IR 5×8×12                                        | G 8×12×3                                   |
|                | –                  | 0,4                  | –                                                | –                                          |
|                | –                  | 0,4                  | IR 5×8×16                                        | –                                          |
| 9              | –                  | 0,4                  | –                                                | G 9×13×3                                   |
|                | –                  | 0,4                  | IR 6×9×12                                        | G 9×13×3                                   |
|                | 8,2                | 0,4                  | IR 6×9×12                                        | G 9×13×3                                   |
|                | –                  | 0,4                  | IR 6×9×12                                        | G 9×13×3                                   |
|                | –                  | 0,4                  | IR 6×9×12                                        | G 9×13×3                                   |
|                | 10,4               | 0,4                  | IR 6×9×12                                        | G 9×13×3                                   |

<sup>1)</sup> For additional information, refer to the section *Needle roller bearing inner rings*, starting on **page 196**.

<sup>2)</sup> For additional information, refer to the section *Radial shaft seals with a low cross sectional height*, starting on **page 208**.

# Drawn cup needle roller bearings

F<sub>w</sub> 10 – 14 mm

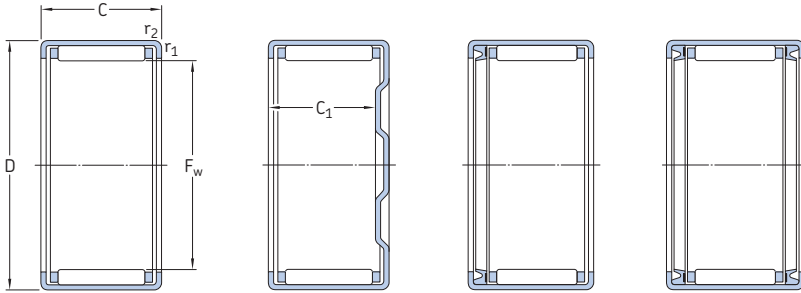

HK

BK

HK..RS

HK...2RS

| Principal dimensions |           |    | Basic load ratings |                | Fatigue load limit | Speed ratings   |                | Mass   | Designation        |                |
|----------------------|-----------|----|--------------------|----------------|--------------------|-----------------|----------------|--------|--------------------|----------------|
| F <sub>w</sub>       | D         | C  | C                  | C <sub>0</sub> | P <sub>u</sub>     | Reference speed | Limiting speed |        |                    |                |
| mm                   |           |    | kN                 |                | kN                 | r/min           |                | kg     | –                  |                |
| <b>10</b>            | 14        | 10 | 4,29               | 5,3            | 0,57               | 18 000          | 20 000         | 0,0041 | <b>HK 1010</b>     |                |
|                      | 14        | 10 | 6,82               | 11,4           | 1,27               | 18 000          | 14 000         | 0,0046 | <b>HN 1010</b>     |                |
|                      | 14        | 10 | 4,29               | 5,3            | 0,57               | 18 000          | 20 000         | 0,0043 | <b>BK 1010</b>     |                |
|                      | 14        | 12 | 5,39               | 6,95           | 0,78               | 18 000          | 20 000         | 0,0048 | <b>HK 1012</b>     |                |
|                      | 14        | 12 | 4,29               | 5,3            | 0,57               | 18 000          | 12 000         | 0,0042 | <b>HK 1012 RS</b>  |                |
|                      | 14        | 12 | 3,19               | 3,55           | 0,365              | 12 000          | 18 000         | 0,0043 | <b>HK 1012.2RS</b> |                |
|                      | 14        | 12 | 5,39               | 6,95           | 0,78               | 18 000          | 20 000         | 0,0050 | <b>BK 1012</b>     |                |
|                      | 14        | 12 | 4,29               | 5,3            | 0,57               | 12 000          | 18 000         | 0,0043 | <b>BK 1012 RS</b>  |                |
|                      | 14        | 14 | 4,29               | 5,3            | 0,57               | –               | 12 000         | 0,0046 | <b>HK 1014.2RS</b> |                |
|                      | 14        | 15 | 6,6                | 9              | 1,02               | 18 000          | 20 000         | 0,0060 | <b>HK 1015</b>     |                |
|                      | 14        | 15 | 6,6                | 9              | 1,02               | 18 000          | 20 000         | 0,0062 | <b>BK 1015</b>     |                |
|                      | <b>12</b> | 16 | 10                 | 4,84           | 6,4                | 0,71            | 16 000         | 18 000 | 0,0046             | <b>HK 1210</b> |
|                      |           | 16 | 10                 | 7,48           | 13,7               | 1,53            | 17 000         | 13 000 | 0,0053             | <b>HN 1210</b> |
|                      |           | 16 | 10                 | 4,84           | 6,4                | 0,71            | 16 000         | 18 000 | 0,0052             | <b>BK 1210</b> |
| 18                   |           | 12 | 6,27               | 7,35           | 0,85               | 16 000          | 18 000         | 0,0090 | <b>HK 1212</b>     |                |
| 18                   |           | 12 | 9,52               | 15,3           | 1,76               | 17 000          | 13 000         | 0,011  | <b>HN 1212</b>     |                |
| 18                   |           | 12 | 6,27               | 7,35           | 0,85               | 16 000          | 18 000         | 0,010  | <b>BK 1212</b>     |                |
| 18                   |           | 14 | 6,27               | 7,35           | 0,85               | 16 000          | 10 000         | 0,010  | <b>HK 1214 RS</b>  |                |
| 16                   |           | 14 | 4,84               | 6,4            | 0,71               | 10 000          | 16 000         | 0,0080 | <b>HK 1214.2RS</b> |                |
| 18                   |           | 16 | 6,27               | 7,35           | 0,85               | –               | 10 000         | 0,011  | <b>HK 1216.2RS</b> |                |
| <b>13</b>            |           | 19 | 12                 | 6,6            | 8                  | 0,915           | 16 000         | 17 000 | 0,010              | <b>HK 1312</b> |
|                      |           | 19 | 12                 | 6,6            | 8                  | 0,915           | 16 000         | 17 000 | 0,011              | <b>BK 1312</b> |
| <b>14</b>            | 20        | 12 | 6,82               | 8,65           | 0,98               | 15 000          | 17 000         | 0,011  | <b>HK 1412</b>     |                |
|                      | 20        | 12 | 10,5               | 17,6           | 2,04               | 15 000          | 12 000         | 0,012  | <b>HN 1412</b>     |                |
|                      | 20        | 12 | 6,82               | 8,65           | 0,98               | 15 000          | 17 000         | 0,012  | <b>BK 1412</b>     |                |
|                      | 20        | 14 | 6,82               | 8,65           | 0,98               | 15 000          | 9 500          | 0,012  | <b>HK 1414 RS</b>  |                |
|                      | 20        | 14 | 6,82               | 8,65           | 0,98               | 15 000          | 9 500          | 0,013  | <b>BK 1414 RS</b>  |                |
|                      | 20        | 16 | 6,82               | 8,65           | 0,98               | –               | 9 500          | 0,013  | <b>HK 1416.2RS</b> |                |

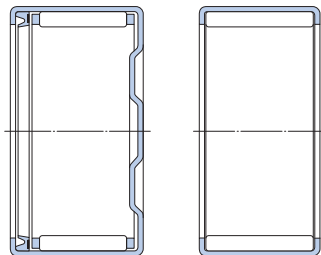

BK..RS

HN

| Dimensions     |                       |                         | Appropriate inner ring <sup>1)</sup><br>Designation | Appropriate seal <sup>2)</sup><br>Designation |
|----------------|-----------------------|-------------------------|-----------------------------------------------------|-----------------------------------------------|
| F <sub>w</sub> | C <sub>1</sub><br>min | r <sub>1,2</sub><br>min |                                                     |                                               |
| mm             |                       |                         |                                                     |                                               |
| 10             | –                     | 0,4                     | LR/IR 7×10×10,5                                     | G 10×14×3                                     |
|                | –                     | 0,4                     | LR/IR 7×10×10,5                                     | G 10×14×3                                     |
|                | 8,4                   | 0,4                     | LR/IR 7×10×10,5                                     | G 10×14×3                                     |
|                | –                     | 0,4                     | IR 7×10×12                                          | G 10×14×3                                     |
|                | –                     | 0,4                     | IR 7×10×12                                          | –                                             |
|                | –                     | 0,4                     | –                                                   | –                                             |
|                | 10,4                  | 0,4                     | IR 7×10×12                                          | G 10×14×3                                     |
|                | 10,4                  | 0,4                     | –                                                   | –                                             |
|                | –                     | 0,4                     | IR 7×10×16                                          | –                                             |
|                | –                     | 0,4                     | IR 7×10×16                                          | G 10×14×3                                     |
| 13,4           | 0,4                   | IR 7×10×16              | G 10×14×3                                           |                                               |
| 12             | –                     | 0,4                     | LR/IR 8×12×10,5                                     | G 12×16×3                                     |
|                | –                     | 0,4                     | LR/IR 8×12×10,5                                     | G 12×16×3                                     |
|                | 8,4                   | 0,4                     | LR/IR 8×12×10,5                                     | G 12×16×3                                     |
|                | –                     | 0,8                     | LR/IR 8×12×12,5                                     | G/SD 12×18×3                                  |
|                | –                     | 0,8                     | LR/IR 8×12×12,5                                     | G/SD 12×18×3                                  |
|                | 9,3                   | 0,8                     | LR/IR 8×12×12,5                                     | G/SD 12×18×3                                  |
|                | –                     | 0,8                     | –                                                   | –                                             |
|                | –                     | 0,4                     | –                                                   | –                                             |
| –              | 0,8                   | IR 9×12×16              | –                                                   |                                               |
| 13             | –                     | 0,8                     | LR/IR 10×13×12,5                                    | G 13×19×3                                     |
|                | 9,3                   | 0,8                     | LR/IR 10×13×12,5                                    | G 13×19×3                                     |
| 14             | –                     | 0,8                     | IR 10×14×13                                         | G/SD 14×20×3                                  |
|                | –                     | 0,8                     | IR 10×14×13                                         | G/SD 14×20×3                                  |
|                | 9,3                   | 0,8                     | IR 10×14×13                                         | G/SD 14×20×3                                  |
|                | –                     | 0,8                     | IR 10×14×16                                         | –                                             |
|                | 11,3                  | 0,8                     | IR 10×14×13                                         | –                                             |
|                | –                     | 0,8                     | IR 10×14×20                                         | –                                             |

<sup>1)</sup> For additional information, refer to the section *Needle roller bearing inner rings*, starting on page 196.

<sup>2)</sup> For additional information, refer to the section *Radial shaft seals with a low cross sectional height*, starting on page 208.

# Drawn cup needle roller bearings

F<sub>w</sub> 15 – 18 mm

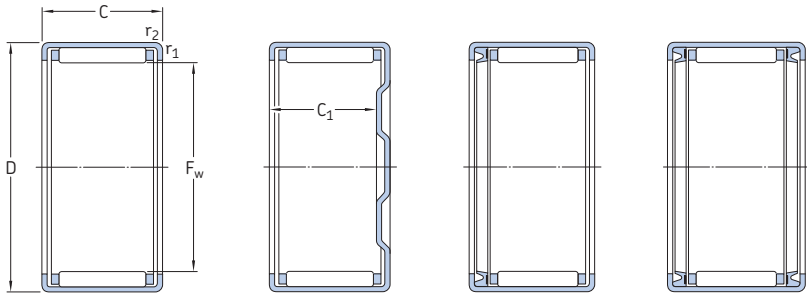

HK

BK

HK..RS

HK...2RS

| Principal dimensions | Basic load ratings |                | Fatigue load limit | Speed ratings   |                | Mass   | Designation |        |                             |
|----------------------|--------------------|----------------|--------------------|-----------------|----------------|--------|-------------|--------|-----------------------------|
|                      | dynamic            | static         |                    | Reference speed | Limiting speed |        |             |        |                             |
| F <sub>w</sub> D C   | C                  | C <sub>0</sub> | P <sub>u</sub>     |                 |                |        |             |        |                             |
| mm                   | kN                 |                | kN                 | r/min           |                | kg     | –           |        |                             |
| <b>15</b>            | 21                 | 12             | 7,65               | 9,5             | 1,08           | 15 000 | 16 000      | 0,011  | <b>HK 1512</b>              |
|                      | 21                 | 12             | 7,65               | 9,5             | 1,08           | 15 000 | 16 000      | 0,013  | <b>BK 1512</b>              |
|                      | 21                 | 14             | 7,48               | 10              | 1,14           | 15 000 | 9 500       | 0,012  | <b>HK 1514 RS</b>           |
|                      | 21                 | 16             | 10,1               | 14,6            | 1,7            | 15 000 | 16 000      | 0,015  | <b>HK 1516</b>              |
|                      | 21                 | 16             | 7,48               | 10              | 1,14           | –      | 9 500       | 0,015  | <b>HK 1516.2RS</b>          |
|                      | 21                 | 16             | 14,5               | 28              | 3,25           | 15 000 | 12 000      | 0,014  | <b>HN 1516</b>              |
|                      | 21                 | 16             | 10,1               | 14,6            | 1,7            | 15 000 | 16 000      | 0,017  | <b>BK 1516</b>              |
|                      | 21                 | 18             | 10,1               | 14,6            | 1,7            | 15 000 | 9 500       | 0,016  | <b>HK 1518 RS</b>           |
|                      | 21                 | 20             | 10,1               | 14,6            | 1,7            | –      | 9 500       | 0,018  | <b>HK 1520.2RS</b>          |
|                      | 21                 | 22             | 13                 | 20              | 2,28           | 15 000 | 16 000      | 0,020  | <b>HK 1522<sup>1)</sup></b> |
|                      | <b>16</b>          | 22             | 12                 | 7,37            | 9,8            | 1,12   | 14 000      | 16 000 | 0,012                       |
| 22                   |                    | 12             | 11,2               | 20,4            | 2,32           | 15 000 | 12 000      | 0,013  | <b>HN 1612</b>              |
| 22                   |                    | 12             | 7,37               | 9,8             | 1,12           | 14 000 | 16 000      | 0,014  | <b>BK 1612</b>              |
| 22                   |                    | 14             | 7,37               | 9,8             | 1,12           | 14 000 | 9 000       | 0,013  | <b>HK 1614 RS</b>           |
| 22                   |                    | 14             | 7,37               | 9,8             | 1,12           | 14 000 | 9 000       | 0,015  | <b>BK 1614 RS</b>           |
| 22                   |                    | 16             | 10,5               | 15,6            | 1,8            | 14 000 | 16 000      | 0,016  | <b>HK 1616</b>              |
| 22                   |                    | 16             | 7,37               | 9,8             | 1,12           | –      | 9 000       | 0,014  | <b>HK 1616.2RS</b>          |
| 22                   |                    | 16             | 10,5               | 15,6            | 1,8            | 14 000 | 16 000      | 0,018  | <b>BK 1616</b>              |
| 22                   |                    | 20             | 11                 | 14,6            | 1,66           | –      | 9 000       | 0,018  | <b>HK 1620.2RS</b>          |
| 22                   |                    | 22             | 12,8               | 19,6            | 2,24           | 14 000 | 16 000      | 0,022  | <b>HK 1622<sup>1)</sup></b> |
| 22                   |                    | 22             | 12,8               | 19,6            | 2,24           | 14 000 | 16 000      | 0,024  | <b>BK 1622<sup>1)</sup></b> |
| <b>17</b>            | 23                 | 12             | 7,65               | 10,6            | 1,2            | 14 000 | 15 000      | 0,012  | <b>HK 1712</b>              |
| <b>18</b>            | 24                 | 12             | 7,92               | 11,2            | 1,27           | 13 000 | 15 000      | 0,013  | <b>HK 1812</b>              |
|                      | 24                 | 12             | 7,92               | 11,2            | 1,27           | 13 000 | 15 000      | 0,015  | <b>BK 1812</b>              |
|                      | 24                 | 14             | 7,92               | 11,2            | 1,27           | 13 000 | 8 500       | 0,014  | <b>HK 1814 RS</b>           |
|                      | 24                 | 16             | 11,2               | 17,6            | 2,04           | 13 000 | 15 000      | 0,018  | <b>HK 1816</b>              |
|                      | 24                 | 16             | 7,92               | 11,2            | 1,27           | –      | 8 500       | 0,015  | <b>HK 1816.2RS</b>          |
|                      | 24                 | 16             | 16,1               | 33,5            | 3,8            | 14 000 | 11 000      | 0,020  | <b>HN 1816</b>              |
|                      | 24                 | 16             | 11,2               | 17,6            | 2,04           | 13 000 | 15 000      | 0,020  | <b>BK 1816</b>              |

<sup>1)</sup> Double row, outer ring with a lubrication hole



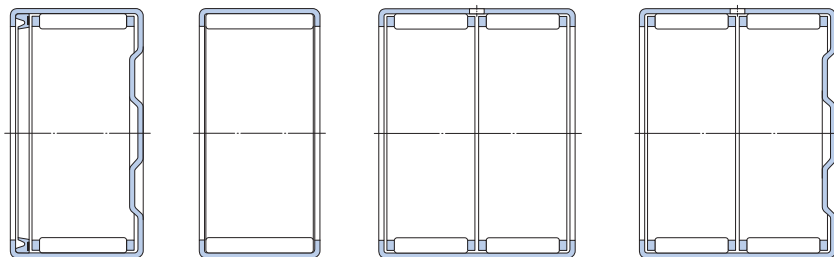

BK..RS

HN

HK  
(double row)BK  
(double row)**Dimensions**
 $F_w$      $C_1$   
min    min

 $r_{1,2}$   
min
**Appropriate  
inner ring<sup>1)</sup>**

Designation

**Appropriate  
seal<sup>2)</sup>**

Designation

mm

|           |      |             |                  |              |
|-----------|------|-------------|------------------|--------------|
| <b>15</b> | –    | 0,8         | LR/IR 12×15×12.5 | G/SD 15×21×3 |
|           | 9,3  | 0,8         | LR/IR 12×15×12.5 | G/SD 15×21×3 |
|           | –    | 0,8         | LR/IR 12×15×16.5 | –            |
|           | –    | 0,8         | LR/IR 12×15×16.5 | G/SD 15×21×3 |
|           | –    | 0,8         | LR/IR 12×15×16.5 | –            |
|           | –    | 0,8         | LR/IR 12×15×16.5 | G/SD 15×21×3 |
|           | 13,3 | 0,8         | LR/IR 12×15×16.5 | G/SD 15×21×3 |
|           | –    | 0,8         | –                | –            |
|           | –    | 0,8         | LR/IR 12×15×22.5 | –            |
|           | –    | 0,8         | LR/IR 12×15×22.5 | G/SD 15×21×3 |
| <b>16</b> | –    | 0,8         | IR 12×16×13      | G/SD 16×22×3 |
|           | –    | 0,8         | IR 12×16×13      | G/SD 16×22×3 |
|           | 9,3  | 0,8         | IR 12×16×13      | G/SD 16×22×3 |
|           | –    | 0,8         | IR 12×16×16      | –            |
|           | 11,3 | 0,8         | IR 12×16×13      | –            |
|           | –    | 0,8         | IR 12×16×16      | G/SD 16×22×3 |
|           | –    | 0,8         | IR 12×16×20      | –            |
|           | 13,3 | 0,8         | IR 12×16×16      | G/SD 16×22×3 |
|           | –    | 0,8         | IR 12×16×22      | –            |
|           | –    | 0,8         | IR 12×16×22      | G/SD 16×22×3 |
| 19,3      | 0,8  | IR 12×16×22 | G/SD 16×22×3     |              |
| <b>17</b> | –    | 0,8         | –                | G/SD 17×23×3 |
|           | –    | 0,8         | –                | –            |
| <b>18</b> | –    | 0,8         | LR 15×18×12.5    | G/SD 18×24×3 |
|           | 9,3  | 0,8         | LR 15×18×12.5    | G/SD 18×24×3 |
|           | –    | 0,8         | LR/IR 15×18×16.5 | –            |
|           | –    | 0,8         | LR/IR 15×18×16.5 | G/SD 18×24×3 |
|           | –    | 0,8         | LR/IR 15×18×16.5 | –            |
|           | –    | 0,8         | LR/IR 15×18×16.5 | G/SD 18×24×3 |
|           | –    | 0,8         | LR/IR 15×18×16.5 | –            |
|           | 13,3 | 0,8         | LR/IR 15×18×16.5 | G/SD 18×24×3 |

<sup>1)</sup> For additional information, refer to the section *Needle roller bearing inner rings*, starting on page 196.

<sup>2)</sup> For additional information, refer to the section *Radial shaft seals with a low cross sectional height*, starting on page 208.

# Drawn cup needle roller bearings

F<sub>w</sub> 20 – 22 mm

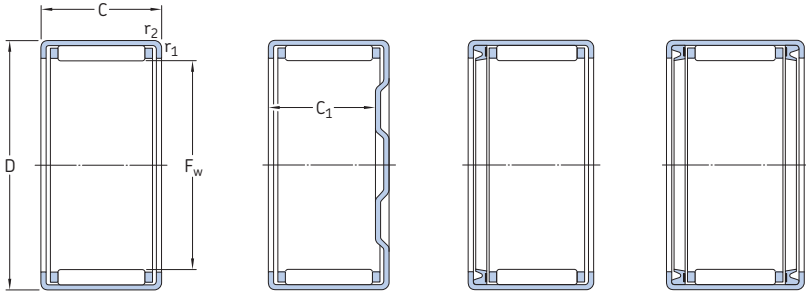

HK

BK

HK..RS

HK...2RS

| Principal dimensions | Basic load ratings |                | Fatigue load limit | Speed ratings   |                | Mass   | Designation |       |                       |
|----------------------|--------------------|----------------|--------------------|-----------------|----------------|--------|-------------|-------|-----------------------|
|                      | dynamic            | static         |                    | Reference speed | Limiting speed |        |             |       |                       |
| F <sub>w</sub> D C   | C                  | C <sub>0</sub> | P <sub>u</sub>     |                 |                |        |             |       |                       |
| mm                   | kN                 |                | kN                 | r/min           |                | kg     | –           |       |                       |
| 20                   | 26                 | 10             | 6,16               | 8,5             | 0,93           | 12 000 | 14 000      | 0,012 | HK 2010               |
|                      | 26                 | 12             | 8,42               | 12,5            | 1,4            | 12 000 | 14 000      | 0,014 | HK 2012               |
|                      | 26                 | 16             | 12,3               | 20,4            | 2,36           | 12 000 | 14 000      | 0,019 | HK 2016               |
|                      | 26                 | 16             | 8,42               | 12,5            | 1,4            | –      | 8 000       | 0,018 | HK 2016.2RS           |
|                      | 26                 | 16             | 16,8               | 36,5            | 4,25           | 12 000 | 10 000      | 0,022 | HN 2016               |
|                      | 26                 | 16             | 12,3               | 20,4            | 2,36           | 12 000 | 14 000      | 0,022 | BK 2016               |
|                      | 26                 | 18             | 12,3               | 20,4            | 2,36           | 12 000 | 8 000       | 0,021 | HK 2018 RS            |
|                      | 26                 | 18             | 12,3               | 20,4            | 2,36           | 12 000 | 8 000       | 0,024 | BK 2018 RS            |
|                      | 26                 | 20             | 15,1               | 26,5            | 3,15           | 12 000 | 14 000      | 0,024 | HK 2020               |
|                      | 26                 | 20             | 12,3               | 20,4            | 2,36           | –      | 8 000       | 0,023 | HK 2020.2RS           |
|                      | 26                 | 20             | 20,9               | 48              | 5,7            | 12 000 | 10 000      | 0,030 | HN 2020               |
|                      | 26                 | 20             | 15,1               | 26,5            | 3,15           | 12 000 | 14 000      | 0,027 | BK 2020 <sup>1)</sup> |
|                      | 26                 | 30             | 20,9               | 40,5            | 4,75           | 12 000 | 14 000      | 0,035 | HK 2030 <sup>1)</sup> |
| 22                   | 28                 | 10             | 7,21               | 10,6            | 1,2            | 11 000 | 12 000      | 0,013 | HK 2210               |
|                      | 28                 | 12             | 8,8                | 13,7            | 1,56           | 11 000 | 12 000      | 0,015 | HK 2212               |
|                      | 28                 | 12             | 8,8                | 13,7            | 1,56           | 11 000 | 12 000      | 0,018 | BK 2212               |
|                      | 28                 | 14             | 8,8                | 13,7            | 1,56           | 11 000 | 7 500       | 0,016 | HK 2214 RS            |
|                      | 28                 | 16             | 13                 | 22,4            | 2,6            | 11 000 | 12 000      | 0,021 | HK 2216               |
|                      | 28                 | 16             | 8,8                | 13,7            | 1,56           | –      | 7 500       | 0,018 | HK 2216.2RS           |
|                      | 28                 | 16             | 13                 | 22,4            | 2,6            | 11 000 | 12 000      | 0,024 | BK 2216               |
|                      | 28                 | 18             | 13                 | 22,4            | 2,6            | 11 000 | 7 500       | 0,024 | HK 2218 RS            |
|                      | 28                 | 20             | 15,7               | 29              | 3,45           | 11 000 | 12 000      | 0,026 | HK 2220               |
|                      | 28                 | 20             | 13                 | 22,4            | 2,6            | –      | 7 500       | 0,026 | HK 2220.2RS           |

<sup>1)</sup> Double row, outer ring with a lubrication hole

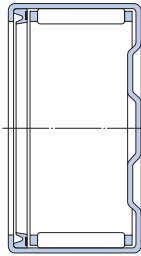

BK..RS

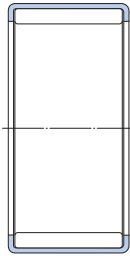

HN

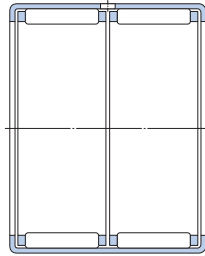
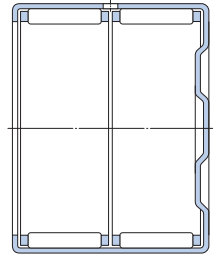
HK  
(double row)BK  
(double row)**Dimensions**

$F_w$      $C_1$   
min

$r_{1,2}$   
min

**Appropriate  
inner ring<sup>1)</sup>**  
Designation

**Appropriate  
seal<sup>2)</sup>**  
Designation

mm

|    |      |     |                  |              |
|----|------|-----|------------------|--------------|
| 20 | –    | 0,8 | IR 15×20×12 IS1  | G/SD 20×26×4 |
|    | –    | 0,8 | IR 15×20×13      | G/SD 20×26×4 |
|    | –    | 0,8 | LR/IR 17×20×16.5 | G/SD 20×26×4 |
|    | –    | 0,8 | LR/IR 17×20×16.5 | –            |
|    | –    | 0,8 | LR/IR 17×20×16.5 | G/SD 20×26×4 |
|    | 13,3 | 0,8 | LR/IR 17×20×16.5 | G/SD 20×26×4 |
|    | –    | 0,8 | LR/IR 17×20×20.5 | –            |
|    | 15,3 | 0,8 | LR/IR 17×20×16.5 | –            |
|    | –    | 0,8 | LR/IR 17×20×20.5 | G/SD 20×26×4 |
|    | –    | 0,8 | LR/IR 17×20×20.5 | –            |
|    | 17,3 | 0,8 | LR/IR 17×20×20.5 | G/SD 20×26×4 |
|    | –    | 0,8 | LR/IR 17×20×20.5 | G/SD 20×26×4 |
|    | –    | 0,8 | LR/IR 17×20×30.5 | G/SD 20×26×4 |
| 22 | –    | 0,8 | IR 17×22×13      | G/SD 22×28×4 |
|    | –    | 0,8 | IR 17×22×13      | G/SD 22×28×4 |
|    | 9,3  | 0,8 | IR 17×22×13      | G/SD 22×28×4 |
|    | –    | 0,8 | IR 17×22×16      | –            |
|    | –    | 0,8 | IR 17×22×16      | G/SD 22×28×4 |
|    | –    | 0,8 | IR 17×22×23      | –            |
|    | 13,3 | 0,8 | IR 17×22×16      | G/SD 22×28×4 |
|    | –    | 0,8 | IR 17×22×23      | –            |
|    | –    | 0,8 | IR 17×22×23      | G/SD 22×28×4 |
|    | –    | 0,8 | IR 17×22×23      | –            |
|    | –    | 0,8 | IR 17×22×23      | –            |

<sup>1)</sup> For additional information, refer to the section *Needle roller bearing inner rings*, starting on **page 196**.

<sup>2)</sup> For additional information, refer to the section *Radial shaft seals with a low cross sectional height*, starting on **page 208**.

# Drawn cup needle roller bearings

$F_w$  25 – 30 mm

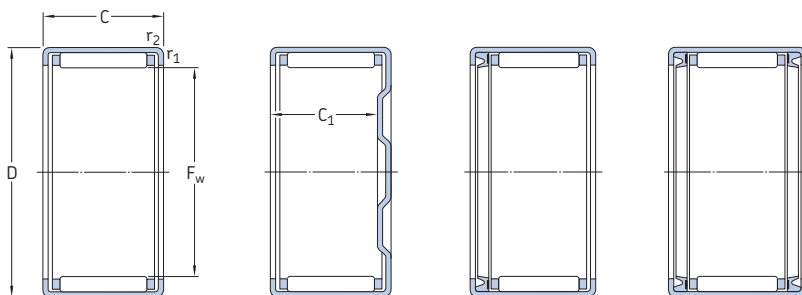

HK

BK

HK..RS

HK...2RS

| Principal dimensions | Basic load ratings |        | Fatigue load limit | Speed ratings   |                | Mass   | Designation |       |                             |                    |
|----------------------|--------------------|--------|--------------------|-----------------|----------------|--------|-------------|-------|-----------------------------|--------------------|
|                      | dynamic            | static |                    | Reference speed | Limiting speed |        |             |       |                             |                    |
| $F_w$                | D                  | C      | C                  | $C_0$           | $P_u$          |        |             |       |                             |                    |
| mm                   |                    |        | kN                 |                 | kN             | r/min  | kg          | –     |                             |                    |
| <b>25</b>            | 32                 | 12     | 10,5               | 15,3            | 1,76           | 9 500  | 11 000      | 0,020 | <b>HK 2512</b>              |                    |
|                      | 32                 | 16     | 15,1               | 24              | 2,85           | 9 500  | 11 000      | 0,027 | <b>HK 2516</b>              |                    |
|                      | 32                 | 16     | 10,5               | 15,3            | 1,76           | –      | 6 700       | 0,027 | <b>HK 2516.2RS</b>          |                    |
|                      | 32                 | 16     | 15,1               | 24              | 2,85           | 11 000 | 9 500       | 0,032 | <b>BK 2516</b>              |                    |
|                      | 32                 | 18     | 15,1               | 24              | 2,85           | 9 500  | 6 700       | 0,029 | <b>HK 2518 RS</b>           |                    |
|                      | 32                 | 18     | 15,1               | 24              | 2,85           | 9 500  | 6 700       | 0,034 | <b>BK 2518 RS</b>           |                    |
|                      | 32                 | 20     | 19                 | 32,5            | 4              | 9 500  | 11 000      | 0,033 | <b>HK 2520</b>              |                    |
|                      | 32                 | 20     | 15,1               | 24              | 2,85           | –      | 6 700       | 0,031 | <b>HK 2520.2RS</b>          |                    |
|                      | 32                 | 20     | 26,4               | 60              | 7,2            | 10 000 | 8 000       | 0,040 | <b>HN 2520</b>              |                    |
|                      | 32                 | 20     | 19                 | 32,5            | 4              | 9 500  | 11 000      | 0,038 | <b>BK 2520</b>              |                    |
|                      | 32                 | 24     | 19                 | 32,5            | 4              | –      | 6 700       | 0,040 | <b>HK 2524.2RS</b>          |                    |
|                      | 32                 | 26     | 24,2               | 45              | 5,5            | 9 500  | 11 000      | 0,044 | <b>HK 2526</b>              |                    |
|                      | 32                 | 26     | 24,2               | 45              | 5,5            | 9 500  | 11 000      | 0,048 | <b>BK 2526</b>              |                    |
|                      | 32                 | 30     | 24,2               | 45              | 5,5            | –      | 6 700       | 0,047 | <b>HK 2530.2RS</b>          |                    |
|                      | 32                 | 38     | 33                 | 65,5            | 8              | 9 500  | 11 000      | 0,064 | <b>HK 2538<sup>1)</sup></b> |                    |
|                      | 32                 | 38     | 33                 | 65,5            | 8              | 9 500  | 11 000      | 0,068 | <b>BK 2538<sup>1)</sup></b> |                    |
|                      | <b>28</b>          | 35     | 16                 | 15,7            | 26,5           | 3,15   | 9 000       | 9 500 | 0,029                       | <b>HK 2816</b>     |
|                      |                    | 35     | 18                 | 15,7            | 26,5           | 3,15   | 6 300       | 9 000 | 0,031                       | <b>HK 2818 RS</b>  |
|                      |                    | 35     | 20                 | 20,1            | 36,5           | 4,4    | 9 000       | 9 500 | 0,036                       | <b>HK 2820</b>     |
|                      |                    | 35     | 20                 | 15,7            | 26,5           | 3,15   | –           | 6 300 | 0,034                       | <b>HK 2820.2RS</b> |
| 35                   |                    | 20     | 28,1               | 68              | 8,15           | 9 000  | 7 000       | 0,044 | <b>HN 2820</b>              |                    |
| <b>30</b>            | 37                 | 12     | 11,7               | 18,3            | 2,12           | 8 000  | 9 000       | 0,023 | <b>HK 3012</b>              |                    |
|                      | 37                 | 12     | 11,7               | 18,3            | 2,12           | 8 000  | 9 000       | 0,028 | <b>BK 3012</b>              |                    |
|                      | 37                 | 16     | 16,5               | 29              | 3,4            | 8 000  | 9 000       | 0,031 | <b>HK 3016</b>              |                    |
|                      | 37                 | 16     | 11,7               | 18,3            | 2,12           | –      | 5 600       | 0,031 | <b>HK 3016.2RS</b>          |                    |
|                      | 37                 | 16     | 16,5               | 29              | 3,4            | 8 000  | 9 000       | 0,038 | <b>BK 3016</b>              |                    |
|                      | 37                 | 18     | 16,5               | 29              | 3,4            | 8 000  | 5 600       | 0,037 | <b>HK 3018 RS</b>           |                    |
|                      | 37                 | 20     | 20,9               | 40              | 4,75           | 8 000  | 9 000       | 0,039 | <b>HK 3020</b>              |                    |
|                      | 37                 | 20     | 16,5               | 29              | 3,4            | –      | 5 600       | 0,036 | <b>HK 3020.2RS</b>          |                    |
|                      | 37                 | 20     | 20,9               | 40              | 4,75           | 8 000  | 9 000       | 0,047 | <b>BK 3020</b>              |                    |
|                      | 37                 | 22     | 23,8               | 46,5            | 5,6            | 9 000  | 8 000       | 0,042 | <b>HK 3022</b>              |                    |
|                      | 37                 | 24     | 20,9               | 40              | 4,75           | –      | 5 600       | 0,044 | <b>HK 3024.2RS</b>          |                    |
|                      | 37                 | 26     | 27                 | 54              | 6,55           | 8 000  | 9 000       | 0,051 | <b>HK 3026</b>              |                    |
|                      | 37                 | 26     | 27                 | 54              | 6,55           | 8 000  | 9 000       | 0,058 | <b>BK 3026</b>              |                    |
|                      | 37                 | 38     | 35,8               | 80              | 9,5            | 8 000  | 9 000       | 0,076 | <b>HK 3038<sup>1)</sup></b> |                    |
|                      | 37                 | 38     | 35,8               | 80              | 9,5            | 8 000  | 9 000       | 0,084 | <b>BK 3038<sup>1)</sup></b> |                    |

<sup>1)</sup> Double row, outer ring with a lubrication hole

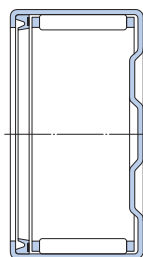

BK..RS

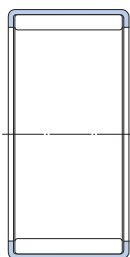

HN

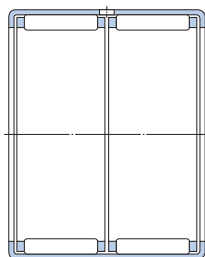
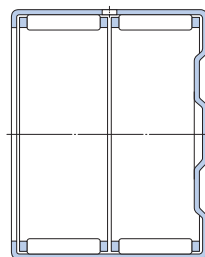
HK  
(double row)BK  
(double row)**Dimensions**

$F_w$      $C_1$   
min    min

$r_{1,2}$   
min

**Appropriate  
inner ring<sup>1)</sup>**  
Designation

**Appropriate  
seal<sup>2)</sup>**  
Designation

mm

|      |      |                  |                             |              |
|------|------|------------------|-----------------------------|--------------|
| 25   | –    | 0,8              | LR 20×25×12.5               | G 25×32×4    |
|      | –    | 0,8              | LR 20×25×16.5 / IR 20×25×17 | G 25×32×4    |
|      | –    | 0,8              | LR 20×25×16.5 / IR 20×25×17 | –            |
|      | 23,3 | 0,8              | –                           | –            |
|      | –    | 0,8              | LR/IR 20×25×20.5            | –            |
|      | 15,3 | 0,8              | LR 20×25×16.5 / IR 20×25×17 | –            |
|      | –    | 0,8              | LR/IR 20×25×20.5            | G 25×32×4    |
|      | –    | 0,8              | LR/IR 20×25×20.5            | –            |
|      | –    | 0,8              | LR/IR 20×25×20.5            | G 25×32×4    |
|      | 17,3 | 0,8              | LR/IR 20×25×20.5            | G 25×32×4    |
|      | –    | 0,8              | LR/IR 20×25×26.5            | –            |
|      | –    | 0,8              | LR/IR 20×25×26.5            | G 25×32×4    |
|      | 23,3 | 0,8              | LR/IR 20×25×26.5            | G 25×32×4    |
|      | –    | 0,8              | IR 20×25×30                 | –            |
|      | –    | 0,8              | LR/IR 20×25×38.5            | G 25×32×4    |
| 35,3 | 0,8  | LR/IR 20×25×38.5 | G 25×32×4                   |              |
| 28   | –    | 0,8              | IR 22×28×17                 | G/SD 28×35×4 |
|      | –    | 0,8              | LR/IR 22×28×20.5            | –            |
|      | –    | 0,8              | LR/IR 22×28×20.5            | G/SD 28×35×4 |
|      | –    | 0,8              | LR/IR 22×28×20.5            | –            |
|      | –    | 0,8              | LR/IR 22×28×20.5            | G/SD 28×35×4 |
| 30   | –    | 0,8              | LR 25×30×12.5               | G/SD 30×37×4 |
|      | –    | 0,8              | LR 25×30×12.5               | G/SD 30×37×4 |
|      | –    | 0,8              | LR 25×30×16.5 / IR 25×30×17 | G/SD 30×37×4 |
|      | –    | 0,8              | LR 25×30×16.5 / IR 25×30×17 | –            |
|      | 13,3 | 0,8              | LR 25×30×16.5 / IR 25×30×17 | G/SD 30×37×4 |
|      | –    | 0,8              | LR/IR 25×30×20.5            | –            |
|      | –    | 0,8              | LR/IR 25×30×20.5            | G/SD 30×37×4 |
|      | –    | 0,8              | LR/IR 25×30×20.5            | –            |
|      | 17,3 | 0,8              | LR/IR 25×30×20.5            | G/SD 30×37×4 |
|      | –    | 0,8              | –                           | G/SD 30×37×4 |
|      | –    | 0,8              | LR/IR 25×30×26.5            | –            |
|      | –    | 0,8              | LR/IR 25×30×26.5            | G/SD 30×37×4 |
|      | 23,3 | 0,8              | LR/IR 25×30×26.5            | G/SD 30×37×4 |
|      | –    | 0,8              | LR/IR 25×30×38.5            | G/SD 30×37×4 |
|      | 35,3 | 0,8              | LR/IR 25×30×38.5            | G/SD 30×37×4 |

<sup>1)</sup> For additional information, refer to the section *Needle roller bearing inner rings*, starting on **page 196**.

<sup>2)</sup> For additional information, refer to the section *Radial shaft seals with a low cross sectional height*, starting on **page 208**.

# Drawn cup needle roller bearings

F<sub>w</sub> 32 – 50 mm

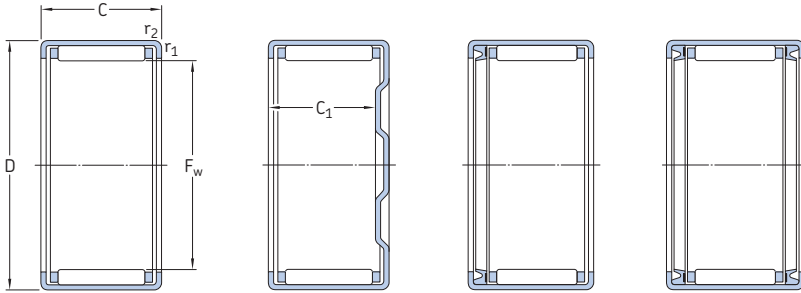

HK

BK

HK..RS

HK...2RS

| Principal dimensions |    |    | Basic load ratings |                | Fatigue load limit | Speed ratings   |                | Mass  | Designation        |
|----------------------|----|----|--------------------|----------------|--------------------|-----------------|----------------|-------|--------------------|
| F <sub>w</sub>       | D  | C  | C                  | C <sub>0</sub> | P <sub>u</sub>     | Reference speed | Limiting speed |       |                    |
| mm                   |    |    | kN                 |                | kN                 | r/min           |                | kg    | –                  |
| <b>32</b>            | 39 | 20 | 22                 | 43             | 5,2                | 8 500           | 7 500          | 0,041 | <b>HK 3220</b>     |
|                      | 39 | 24 | 26,4               | 54             | 6,55               | 8 500           | 7 500          | 0,049 | <b>HK 3224</b>     |
| <b>35</b>            | 42 | 12 | 12,5               | 21,6           | 2,45               | 7 000           | 8 000          | 0,027 | <b>HK 3512</b>     |
|                      | 42 | 16 | 17,9               | 34             | 4                  | 7 000           | 8 000          | 0,036 | <b>HK 3516</b>     |
|                      | 42 | 16 | 12,5               | 21,6           | 2,45               | –               | 5 000          | 0,032 | <b>HK 3516.2RS</b> |
|                      | 42 | 18 | 17,9               | 34             | 4                  | 7 000           | 5 000          | 0,039 | <b>HK 3518 RS</b>  |
|                      | 42 | 20 | 22,9               | 46,5           | 5,6                | 7 000           | 8 000          | 0,044 | <b>HK 3520</b>     |
|                      | 42 | 20 | 17,9               | 34             | 4                  | –               | 5 000          | 0,041 | <b>HK 3520.2RS</b> |
|                      | 42 | 20 | 31,4               | 83             | 10,2               | 7 500           | 6 000          | 0,054 | <b>HN 3520</b>     |
|                      | 42 | 20 | 22,9               | 46,5           | 5,6                | 7 000           | 8 000          | 0,053 | <b>BK 3520</b>     |
| <b>40</b>            | 47 | 12 | 13,4               | 24,5           | 2,8                | 6 300           | 7 000          | 0,030 | <b>HK 4012</b>     |
|                      | 47 | 16 | 19                 | 39             | 4,55               | 6 300           | 7 000          | 0,039 | <b>HK 4016</b>     |
|                      | 47 | 16 | 13,4               | 24,5           | 2,8                | –               | 4 500          | 0,037 | <b>HK 4016.2RS</b> |
|                      | 47 | 18 | 19                 | 39             | 4,55               | 6 300           | 4 500          | 0,045 | <b>HK 4018 RS</b>  |
|                      | 47 | 20 | 24,2               | 53             | 6,4                | 6 300           | 7 000          | 0,054 | <b>HK 4020</b>     |
|                      | 47 | 20 | 19                 | 39             | 4,55               | –               | 4 500          | 0,048 | <b>HK 4020.2RS</b> |
|                      | 47 | 20 | 33,6               | 95             | 11,6               | 6 300           | 5 000          | 0,061 | <b>HN 4020</b>     |
|                      | 47 | 20 | 24,2               | 53             | 6,4                | 6 300           | 7 000          | 0,062 | <b>BK 4020</b>     |
| <b>45</b>            | 52 | 12 | 14,2               | 27,5           | 3,2                | 5 600           | 6 300          | 0,033 | <b>HK 4512</b>     |
|                      | 52 | 16 | 20,5               | 43             | 5,1                | 5 600           | 6 300          | 0,046 | <b>HK 4516</b>     |
|                      | 52 | 18 | 20,5               | 43             | 5,1                | 5 600           | 4 000          | 0,050 | <b>HK 4518 RS</b>  |
|                      | 52 | 20 | 26                 | 60             | 7,2                | 5 600           | 6 300          | 0,056 | <b>HK 4520</b>     |
|                      | 52 | 20 | 20,5               | 43             | 5,1                | –               | 4 000          | 0,054 | <b>HK 4520.2RS</b> |
|                      | 52 | 20 | 35,8               | 108            | 13,2               | 5 600           | 4 500          | 0,066 | <b>HN 4520</b>     |
|                      | 52 | 20 | 26                 | 60             | 7,2                | 5 600           | 6 300          | 0,072 | <b>BK 4520</b>     |
|                      | 52 | 25 | 44                 | 140            | 17                 | 5 600           | 4 500          | 0,085 | <b>HN 4525</b>     |
| <b>50</b>            | 58 | 20 | 29,2               | 63             | 7,8                | 5 000           | 5 600          | 0,070 | <b>HK 5020</b>     |
|                      | 58 | 20 | 41,8               | 120            | 14,3               | 5 000           | 4 000          | 0,085 | <b>HN 5020</b>     |
|                      | 58 | 22 | 29,2               | 63             | 7,8                | 5 000           | 3 600          | 0,076 | <b>HK 5022 RS</b>  |
|                      | 58 | 24 | 29,2               | 63             | 7,8                | –               | 3 600          | 0,081 | <b>HK 5024.2RS</b> |
|                      | 58 | 25 | 36,9               | 85             | 10,6               | 5 000           | 5 600          | 0,090 | <b>HK 5025</b>     |
|                      | 58 | 25 | 50,1               | 153            | 18,6               | 5 000           | 4 000          | 0,11  | <b>HN 5025</b>     |

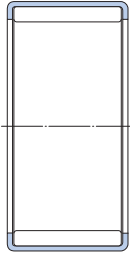

HN

| Dimensions     |                       |                         | Appropriate inner ring <sup>1)</sup><br>Designation | Appropriate seal <sup>2)</sup><br>Designation |              |
|----------------|-----------------------|-------------------------|-----------------------------------------------------|-----------------------------------------------|--------------|
| F <sub>w</sub> | C <sub>1</sub><br>min | r <sub>1,2</sub><br>min |                                                     |                                               |              |
| mm             |                       |                         |                                                     |                                               |              |
| 32             | –                     | 0,8                     | –                                                   | –                                             |              |
|                | –                     | 0,8                     | –                                                   | –                                             |              |
| 35             | –                     | 0,8                     | LR 30×35×12.5                                       | G/SD 35×42×4                                  |              |
|                | –                     | 0,8                     | LR 30×35×16.5 / IR 30×35×17                         | G/SD 35×42×4                                  |              |
|                | –                     | 0,8                     | LR 30×35×16.5 / IR 30×35×17                         | –                                             |              |
|                | –                     | 0,8                     | LR/IR 30×35×20.5                                    | –                                             |              |
|                | –                     | 0,8                     | LR/IR 30×35×20.5                                    | G/SD 35×42×4                                  |              |
|                | –                     | 0,8                     | LR/IR 30×35×20.5                                    | –                                             |              |
|                | –                     | 0,8                     | LR/IR 30×35×20.5                                    | G/SD 35×42×4                                  |              |
|                | –                     | 17,3                    | 0,8                                                 | LR/IR 30×35×20.5                              | G/SD 35×42×4 |
| 40             | –                     | 0,8                     | LR 35×40×12.5                                       | G/SD 40×47×4                                  |              |
|                | –                     | 0,8                     | LR 35×40×16.5 / IR 35×40×17                         | G/SD 40×47×4                                  |              |
|                | –                     | 0,8                     | LR 35×40×16.5 / IR 35×40×17                         | –                                             |              |
|                | –                     | 0,8                     | LR/IR 35×40×20.5                                    | –                                             |              |
|                | –                     | 0,8                     | LR/IR 35×40×20.5                                    | G/SD 40×47×4                                  |              |
|                | –                     | 0,8                     | LR/IR 35×40×20.5                                    | –                                             |              |
|                | –                     | 0,8                     | LR/IR 35×40×20.5                                    | G/SD 40×47×4                                  |              |
|                | –                     | 17,3                    | 0,8                                                 | LR/IR 35×40×20.5                              | G/SD 40×47×4 |
| 45             | –                     | 0,8                     | –                                                   | G/SD 45×52×4                                  |              |
|                | –                     | 0,8                     | LR 40×45×16.5 / IR 40×45×17                         | G/SD 45×52×4                                  |              |
|                | –                     | 0,8                     | LR/IR 40×45×20.5                                    | –                                             |              |
|                | –                     | 0,8                     | LR/IR 40×45×20.5                                    | G/SD 45×52×4                                  |              |
|                | –                     | 0,8                     | LR/IR 40×45×20.5                                    | –                                             |              |
|                | –                     | 0,8                     | LR/IR 40×45×20.5                                    | G/SD 45×52×4                                  |              |
|                | –                     | 17,3                    | 0,8                                                 | LR/IR 40×45×20.5                              | G/SD 45×52×4 |
|                | –                     | –                       | 0,8                                                 | –                                             | G/SD 45×52×4 |
| 50             | –                     | 0,8                     | LR 45×50×20.5 / IR 40×50×20 IS1                     | G/SD 50×58×4                                  |              |
|                | –                     | 0,8                     | LR/IR 40×50×20 IS1                                  | G/SD 50×58×4                                  |              |
|                | –                     | 0,8                     | LR/IR 45×50×25.5                                    | –                                             |              |
|                | –                     | 0,8                     | LR/IR 45×50×25.5                                    | –                                             |              |
|                | –                     | 0,8                     | LR/IR 45×50×25.5                                    | G/SD 50×58×4                                  |              |
|                | –                     | 0,8                     | LR/IR 45×50×25.5                                    | G/SD 50×58×4                                  |              |

<sup>1)</sup> For additional information, refer to the section *Needle roller bearing inner rings*, starting on page 196.

<sup>2)</sup> For additional information, refer to the section *Radial shaft seals with a low cross sectional height*, starting on page 208.

**Drawn cup needle roller bearings**  
 $F_w$  55 – 60 mm

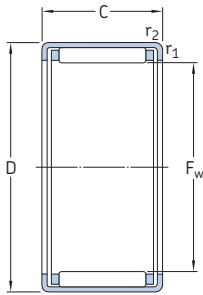

HK

| Principal dimensions |    |    | Basic load ratings |        | Fatigue load limit | Speed ratings   |                | Mass  | Designation    |
|----------------------|----|----|--------------------|--------|--------------------|-----------------|----------------|-------|----------------|
| $F_w$                | D  | C  | dynamic            | static | $P_u$              | Reference speed | Limiting speed |       |                |
| mm                   |    |    | kN                 |        | kN                 | r/min           |                | kg    | –              |
| <b>55</b>            | 63 | 20 | 30,3               | 67     | 8,3                | 4 500           | 5 000          | 0,074 | <b>HK 5520</b> |
|                      | 63 | 28 | 41,8               | 104    | 12,9               | 4 500           | 5 000          | 0,11  | <b>HK 5528</b> |
| <b>60</b>            | 68 | 12 | 17,6               | 32     | 3,8                | 4 300           | 4 800          | 0,049 | <b>HK 6012</b> |
|                      | 68 | 20 | 31,9               | 75     | 9,3                | 4 300           | 4 800          | 0,081 | <b>HK 6020</b> |
|                      | 68 | 32 | 51,2               | 137    | 17                 | 4 300           | 4 800          | 0,14  | <b>HK 6032</b> |



| Dimensions     |                         | Appropriate inner ring <sup>1)</sup><br>Designation | Appropriate seal <sup>2)</sup><br>Designation |
|----------------|-------------------------|-----------------------------------------------------|-----------------------------------------------|
| F <sub>w</sub> | r <sub>1,2</sub><br>min |                                                     |                                               |
| mm             |                         |                                                     |                                               |
| 55             | 0,8                     | LR 50×55×20.5                                       | G 55×63×5                                     |
|                | 0,8                     | –                                                   | G 55×63×5                                     |
| 60             | 0,8                     | –                                                   | –                                             |
|                | 0,8                     | –                                                   | –                                             |
|                | 0,8                     | –                                                   | –                                             |

<sup>1)</sup> For additional information, refer to the section *Needle roller bearing inner rings*, starting on **page 196**.

<sup>2)</sup> For additional information, refer to the section *Radial shaft seals with a low cross sectional height*, starting on **page 208**.



# Needle roller bearings with machined rings

|                                                                                             |            |
|---------------------------------------------------------------------------------------------|------------|
| Needle roller bearings with machined rings with flanges .....                               | 100        |
| Needle roller bearings with machined rings without flanges .....                            | 102        |
| Dimensions.....                                                                             | 102        |
| Tolerances .....                                                                            | 102        |
| Internal clearance .....                                                                    | 103        |
| Misalignment.....                                                                           | 101        |
| Cages .....                                                                                 | 104        |
| Shaft and housing tolerances .....                                                          | 104        |
| Supplementary designations.....                                                             | 105        |
| <b>Product tables .....</b>                                                                 | <b>106</b> |
| 4.1 Needle roller bearings with machined rings with flanges, without an inner ring.....     | 106        |
| 4.2 Needle roller bearings with machined rings with flanges, with an inner ring .....       | 122        |
| 4.3 Needle roller bearings with machined rings without flanges, without an inner ring ..... | 134        |
| 4.4 Needle roller bearings with machined rings without flanges, with an inner ring.....     | 138        |

## Needle roller bearings with machined rings

Needle roller bearings with machined rings made of carbon chromium bearing steel have a low sectional height and a very high load carrying capacity for their size. They may be used with or without an inner ring, depending on the application.

Needle roller bearings without an inner ring (→ **fig. 1**) are an excellent choice for compact bearing arrangements if the shaft can be hardened and ground. Eliminating the need for a separate inner ring enables a larger shaft diameter and a stiffer arrangement. Axial displacement of the shaft relative to the housing is only limited by the width of the raceway on the shaft. By machining the shaft raceways to the appropriate dimensional and form accuracy, it is possible to obtain bearing arrangements with heightened running accuracy. For additional information, refer to the section *Raceways on shafts and in housings* on **page 50** and to *Internal clearance* on **page 42**.

Needle roller bearings with an inner ring (→ **fig. 2**) are used for arrangements where it is not possible or uneconomical to harden and grind the shaft. Bearings with an inner ring only permit axial displacement of the shaft relative to the housing within certain limits. If the permissible axial displacement provided by a standard inner ring is insufficient, it is possible to use an extended inner ring. Extended inner rings can also provide an excellent counterface for the lips of external G or SD seals. For additional information, refer to the section *Needle roller bearing components*, starting on **page 195**.

SKF supplies needle roller bearings in several designs and sizes:

- with flanges (closure rings or integral flanges) on the outer ring (→ **figs. 3** and **4**), sealed (→ **fig. 5**) or not sealed and with or without an inner ring
- without flanges on the outer ring (→ **fig. 6**), not sealed and with or without an inner ring

To accommodate combined radial and axial loads, needle roller bearings of certain sizes can be combined with needle roller thrust bearings with a centring spigot, AXW series (→ **fig. 7**).

Fig. 1

Needle roller bearing without an inner ring

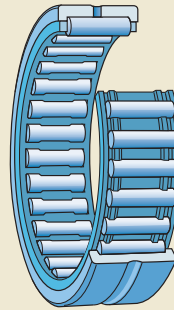

Fig. 2

Needle roller bearing with an inner ring

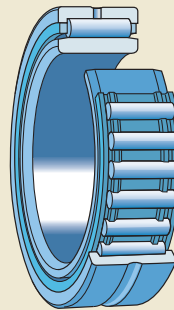

Fig. 3

Needle roller bearing with inserted closure rings (for bearings with  $F_w \leq 10$  mm)

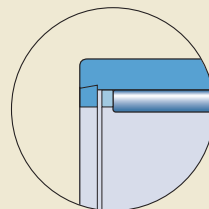

Fig. 4

Needle roller bearing with integral outer ring flanges  
(for bearings with  $F_w \geq 12$  mm)

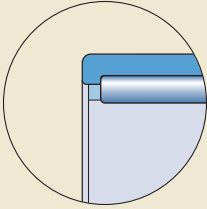

Fig. 7

Needle roller bearing combined with a needle roller thrust bearing, AXW series

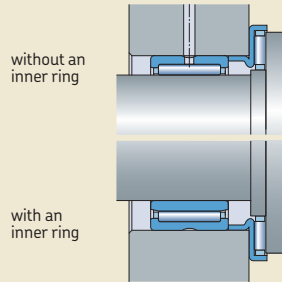

Fig. 5

Needle roller bearing, sealed

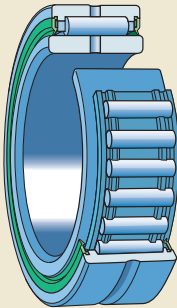
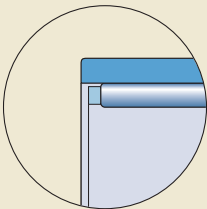

Fig. 6

Needle roller bearing without flanges on the outer ring



## Needle roller bearings with machined rings with flanges

SKF needle roller bearings with flanges on the outer ring and with an outside diameter up to and including 17 mm ( $F_w \leq 10$  mm), are manufactured with inserted closure rings. These bearings do not have a lubrication hole or an annular groove (→ **fig. 8**). Larger bearings have integral flanges on the outer ring, an annular groove and, depending on the bearing size, one or more lubrication holes in the outer ring (→ **fig. 9**). Needle roller bearings with flanges are generally designed as single row bearings. Bearings in the RNA 69 and NA 69 series, with an outside diameter  $D \geq 52$  mm, have two needle roller and cage assemblies (→ **fig. 10**). The outer ring and cage assembly of a needle roller bearing with flanges form a non-separable unit.

Fig. 8

Design with inserted closure rings, without a lubrication hole

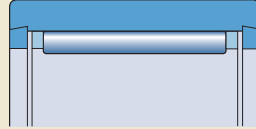

NK series ( $F_w \leq 10$  mm)

Fig. 9

Design with integral flanges, with a lubrication hole and an annular groove

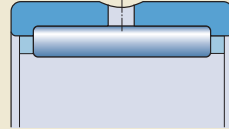

NK series ( $F_w \geq 12$  mm)  
 NKS series  
 RNA 48 series  
 RNA 49 series  
 RNA 69 series ( $D \leq 47$  mm)

Fig. 10

Needle roller bearing, double row

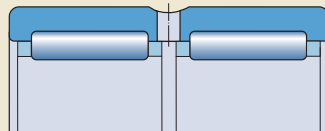

RNA series ( $D \geq 52$  mm)

## Sealed bearings

Single row bearings, in the RNA 49 and NA 49 series, are also available with a contact seal on one (→ **fig. 11**) or both sides (→ **fig. 12**). The seals are made of acrylonitrile-butadiene rubber (NBR) that efficiently protects the bearing against the entry of contaminants and retains the lubricant in the bearing.

The operating temperature range for sealed needle roller bearings with machined rings, which is limited by the seal material and the grease fill, is  $-20\text{ °C}$  to  $+100\text{ °C}$ .

The inner ring of sealed bearings is 1 mm wider than the outer ring. This maintains the efficiency of the seals even when a small amount of axial displacement occurs.

## Initial grease fill and relubrication

Sealed needle roller bearings with machined rings are filled at the factory with a high-quality grease with good rust inhibiting properties. Because these bearings can hold a relatively large quantity of grease, they can be operated for long periods before relubrication is required. The lubrication groove and lubrication hole in the outer ring enable the lubricant to reach the bearing cavity during relubrication. The inner ring is also provided with a lubrication hole so that the bearing can be relubricated either via the outer or inner ring, depending on the application. SKF recommends SKF LGWA 2 grease for relubrication. For additional information about greases, refer to the section *Lubrication*, starting on **page 52**.

## External seals

SKF supplies an assortment of radial shaft seals that can be used as external seals. Extended inner rings can be used if the inner ring raceway is to serve as a counterface for a seal adjacent to the bearing. Appropriate seals are listed in the product tables, when available. For additional information, refer to the section *Needle roller bearing components*, starting on **page 195**.

Fig. 11

Needle roller bearing, sealed on one side

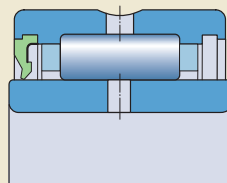

NA 49.. RS series

Fig. 12

Needle roller bearing, sealed on both sides

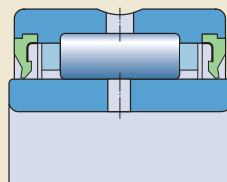

NA 49...2RS series

## Needle roller bearings with machined rings without flanges

Needle roller bearings without flanges are completely separable, i.e. the outer ring, the needle roller and cage assembly and the inner ring can all be mounted separately. In many applications, this makes mounting a great deal easier. The needle roller and cage assembly can either be mounted together with the outer ring or with the shaft or inner ring, depending on the arrangement design. It can also be inserted between the outer ring and shaft or inner ring as the final step. However, needle roller and cage assemblies and bearing outer rings must always be kept together as supplied.

SKF needle roller bearings without flanges are available as single row (→ **fig. 13**) or double row bearings (→ **fig. 14**). Double row bearings have two needle roller and cage assemblies arranged adjacent to each other. They have an annular groove and a lubrication hole in the outer ring to enable efficient lubrication.

To provide efficient lubrication for needle roller bearings with an inner ring, SKF supplies some bearings with one lubrication hole in the inner ring. These bearings are listed in the product table. The cage of needle roller bearings without flanges must be axially guided by fine turned and burr-free surfaces on adjacent machine components. Recommended dimensions for these surfaces are listed in the product tables.

## Dimensions

The boundary dimensions of SKF needle roller bearings with machined rings in the RNA 48, RNA 49, RNA 69, NA 48, NA 49 and NA 69 series are in accordance with ISO 1206-2001. The dimensions of the other needle roller bearings do not adhere to any national or international standards, but are common in the market.

## Tolerances

SKF supplies needle roller bearings with machined rings to Normal tolerances in accordance with ISO 492:2002, as standard.

On request, needle roller bearings with higher accuracy to tolerance P6 or P5 specifications can be supplied. For bearing arrangements with higher accuracy, inner rings with a pre-ground raceway and a machining allowance can be supplied, but must be finish ground after mounting.

The inside diameter  $F_w$  of the needle roller and cage assembly, when the rollers are in contact with the outer ring raceway, lies within the limits of F6 tolerance class (→ **table 1**) before the bearings are mounted.

On request, SKF supplies needle roller bearings without an inner ring and with reduced inside diameter tolerances. These bearings are identified by the designation suffix H followed by a figure combination that gives the actual maximum and minimum values in  $\mu\text{m}$  for the deviation from the nominal inside diameter  $F_w$ , e.g. H+24+20.

Fig. 13

Needle roller bearing, single row, with an inner ring

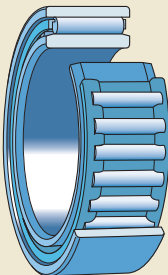

NAO series

Fig. 14

Needle roller bearing, double row, without an inner ring

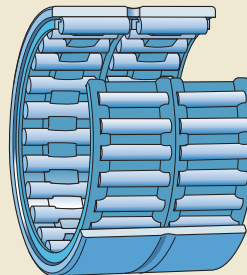

RNAO series



## Internal clearance

SKF needle roller bearings with an inner ring have Normal radial internal clearance as standard. The clearance values are listed in **table 7** on **page 42** and are in accordance with ISO 5753-1:2009. They are valid for unmounted bearings under zero measuring load.

For needle roller bearings without an inner ring, a suitable internal clearance is achieved by selecting the appropriate tolerance class for the raceway diameter. Recommended values are listed in **table 2**. The recommendations apply, provided the housing bore is not tighter than a K7 tolerance class.

## Misalignment

The ends of the needle rollers are relieved slightly to modify the line contact between the raceways and rollers. This provides favourable load distribution in the bearing and minimizes damaging edge stresses. It also enables needle roller bearings with machined rings to accommodate a small amount of misalignment, approximately 1 min of arc between the shaft and housing.

The detrimental effects of misalignment increase with increasing bearing width and load. For additional information, contact the SKF application engineering service.

Table 1

| ISO tolerance class     |       | F6 tolerance class |     |
|-------------------------|-------|--------------------|-----|
| Nominal inside diameter |       |                    |     |
| $F_w$ over              | incl. | high               | low |
| mm                      |       | µm                 |     |
| –                       | 3     | +12                | +6  |
| 3                       | 6     | +18                | +10 |
| 6                       | 10    | +22                | +13 |
| 10                      | 18    | +27                | +16 |
| 18                      | 30    | +33                | +20 |
| 30                      | 50    | +41                | +25 |
| 50                      | 80    | +49                | +30 |
| 80                      | 120   | +58                | +36 |
| 120                     | 180   | +68                | +43 |
| 180                     | 250   | +79                | +50 |
| 250                     | 315   | +88                | +56 |
| 315                     | 400   | +98                | +62 |
| 400                     | 500   | +108               | +68 |

Table 2

| Shaft tolerance classes for needle roller bearings without an inner ring |       |                                                                          |        |             |
|--------------------------------------------------------------------------|-------|--------------------------------------------------------------------------|--------|-------------|
| Nominal inside diameter                                                  |       | Shaft tolerance classes for shaft raceways to give operational clearance |        |             |
| $F_w$ over                                                               | incl. | lower side                                                               | medium | higher side |
| mm                                                                       |       | –                                                                        |        |             |
| –                                                                        | 65    | k5                                                                       | h5     | g6          |
| 65                                                                       | 80    | k5                                                                       | h5     | f6          |
| 80                                                                       | 160   | k5                                                                       | g5     | f6          |
| 160                                                                      | 180   | k5                                                                       | g5     | e6          |
| 180                                                                      | 200   | j5                                                                       | g5     | e6          |
| 200                                                                      | 250   | j5                                                                       | f6     | e6          |
| 250                                                                      | 315   | h5                                                                       | f6     | e6          |
| 315                                                                      | 400   | g5                                                                       | f6     | d6          |

Fig. 15

Machined steel cage

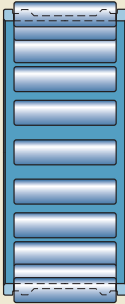

Fig. 16

Sheet steel cage

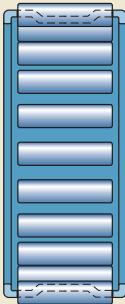
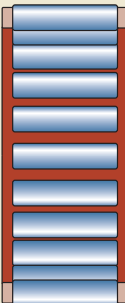

Fig. 17

Polyamide 66 cage



## Cages

Depending on their size, SKF needle roller bearings with machined rings are fitted as standard with a machined steel (→ fig. 15) or sheet steel cage (→ fig. 16), no designation suffix. A number of bearings are fitted as standard with an injection moulded cage of glass fibre reinforced polyamide 66 (→ fig. 17), designation suffix TN.

### Note

Needle roller bearings with a polyamide 66 cage that are not sealed can be operated at temperatures up to 120 °C. The lubricants generally used for rolling bearings do not have a detrimental effect on cage properties. Exceptions are a few synthetic oils and greases with a synthetic oil base and lubricants containing a high proportion of EP additives when used at high temperatures.

For bearing arrangements that operate at continuously high temperatures or under arduous conditions, SKF recommends using bearings with a steel cage.

For additional information about the temperature resistance and the applicability of cages, refer to the section *Cage materials*, starting on page 44.

## Shaft and housing tolerances

The shaft tolerances for SKF needle roller bearings with machined rings should be in accordance with the fits that are listed in table 3.

When needle roller bearings with an inner ring are used under conditions of point load and mounted with a loose fit, the inner ring seat should be machined to h6 or g6 tolerance class.

When the load rotates, the inner rings should have an interference fit. Sufficient interference can be obtained if the recommended shaft tolerance classes (→ table 3) are applied.

For information about housing tolerances for needle roller bearings with an inner ring, refer to the SKF *General Catalogue*, section *Application of bearings/Recommended fits*.

Table 3

Fits for needle roller bearings with machined rings with an inner ring on solid steel shafts

| Conditions                                                                                            | Shaft diameter                                         | Tolerance class                                          |
|-------------------------------------------------------------------------------------------------------|--------------------------------------------------------|----------------------------------------------------------|
| –                                                                                                     | mm                                                     | –                                                        |
| <b>Rotating inner ring load or direction of load indeterminate</b>                                    |                                                        |                                                          |
| <b>Light and variable loads</b><br>( $P \leq 0,05 C$ )                                                | $\leq 10$<br>(10) to 25<br>(25) to 100                 | k5<br>k6<br>m6                                           |
| <b>Normal to heavy loads</b><br>( $P > 0,05 C$ )                                                      | $\leq 25$<br>(25) to 60<br>(60) to 100<br>(100) to 400 | k5<br>m6<br>n6<br>p6 <sup>1)</sup>                       |
| <b>Heavy to very heavy loads</b><br>( $P > 0,1 C$ )                                                   | (50) to 100<br>(100) to 200<br>> 200                   | n6 <sup>1)</sup><br>p6 <sup>1)</sup><br>r6 <sup>1)</sup> |
| <b>Stationary inner ring load</b><br>Easy axial displacement of the inner ring on the shaft necessary |                                                        | g6                                                       |
| Easy axial displacement of the inner ring on the shaft unnecessary                                    |                                                        | h6                                                       |

<sup>1)</sup> Bearings with radial internal clearance greater than Normal may be necessary.

## Supplementary designations

The designation suffixes used to identify certain features of SKF needle roller bearings are explained in the following.

- C2** Bearing internal clearance smaller than Normal
- C3** Radial internal clearance greater than Normal
- C4** Radial internal clearance greater than C3
- CN** Bearing internal clearance Normal, only used together with an additional letter (H, L, M, P) that identifies a reduced or displaced clearance range
- H..** Needle roller bearing without an inner ring, with reduced inside diameter (under rollers) tolerance, followed by tolerance limits in  $\mu\text{m}$ , e.g. H+27+20
- IS..** Needle roller bearing with one or more lubricating holes in the inner ring, a figure following indicates the number of holes
- ISR..** Needle roller bearing with an annular groove and one or more lubricating holes in the inner ring, a figure following indicates the number of holes
- P5** Dimensional and running accuracy to ISO tolerance class 5 specifications (better than P6)
- P6** Dimensional and running accuracy to ISO tolerance class 6 specifications (better than Normal)
- RS** Contact seal of acrylonitrile-butadiene rubber (NRB) with or without sheet steel reinforcement on one side of the bearing
- .2RS** RS contact seal on both sides of the bearing
- TN** Injection moulded cage of glass fibre reinforced polyamide 66, rolling element centred

## Needle roller bearings with machined rings with flanges, without an inner ring

$F_w$  5 – 16 mm

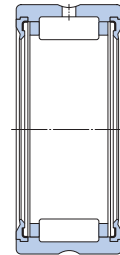
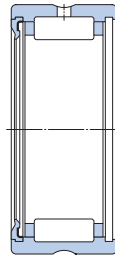
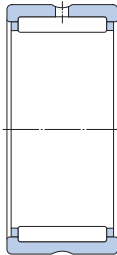
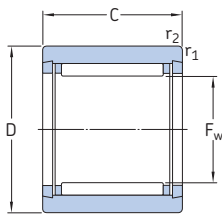

NK ( $F_w \leq 10$  mm)

NK ( $F_w \geq 12$  mm)  
RNA 49  
RNA 6901

RNA 49..RS

RNA 49...2RS

| Principal dimensions |    |    | Basic load ratings |        | Fatigue load limit<br>$P_u$ | Speed ratings   |                | Mass   | Designation                                                                 |
|----------------------|----|----|--------------------|--------|-----------------------------|-----------------|----------------|--------|-----------------------------------------------------------------------------|
| $F_w$                | D  | C  | dynamic            | static |                             | Reference speed | Limiting speed |        |                                                                             |
| mm                   |    |    | C                  | $C_0$  | kN                          | r/min           | kg             | –      |                                                                             |
| 5                    | 10 | 10 | 2,29               | 2      | 0,212                       | 36 000          | 40 000         | 0,0031 | NK 5/10 TN<br>NK 5/12 TN                                                    |
|                      | 10 | 12 | 2,92               | 2,7    | 0,29                        | 36 000          | 40 000         | 0,0037 |                                                                             |
| 6                    | 12 | 10 | 2,55               | 2,36   | 0,25                        | 34 000          | 38 000         | 0,0047 | NK 6/10 TN<br>NK 6/12 TN                                                    |
|                      | 12 | 12 | 3,3                | 3,2    | 0,345                       | 34 000          | 38 000         | 0,0057 |                                                                             |
| 7                    | 14 | 10 | 2,81               | 2,75   | 0,29                        | 32 000          | 36 000         | 0,0069 | NK 7/10 TN<br>NK 7/12 TN                                                    |
|                      | 14 | 12 | 3,58               | 3,75   | 0,415                       | 32 000          | 36 000         | 0,0082 |                                                                             |
| 8                    | 15 | 12 | 3,8                | 4,25   | 0,465                       | 32 000          | 36 000         | 0,0087 | NK 8/12 TN<br>NK 8/16 TN                                                    |
|                      | 15 | 16 | 5,01               | 5,85   | 0,67                        | 32 000          | 36 000         | 0,012  |                                                                             |
| 9                    | 16 | 12 | 4,4                | 5,2    | 0,57                        | 30 000          | 34 000         | 0,010  | NK 9/12 TN<br>NK 9/16 TN                                                    |
|                      | 16 | 16 | 5,72               | 7,2    | 0,815                       | 30 000          | 34 000         | 0,013  |                                                                             |
| 10                   | 17 | 12 | 4,4                | 5,4    | 0,62                        | 28 000          | 32 000         | 0,010  | NK 10/12 TN<br>NK 10/16 TN                                                  |
|                      | 17 | 16 | 5,94               | 8      | 0,9                         | 28 000          | 32 000         | 0,013  |                                                                             |
| 12                   | 19 | 12 | 6,71               | 8,15   | 0,965                       | 26 000          | 30 000         | 0,012  | NK 12/12<br>NK 12/16                                                        |
|                      | 19 | 16 | 9,13               | 12     | 1,46                        | 26 000          | 30 000         | 0,016  |                                                                             |
| 14                   | 22 | 13 | 8,8                | 10,4   | 1,25                        | 26 000          | 30 000         | 0,017  | RNA 4900<br>RNA 4900 RS<br>RNA 4900.2RS<br>NK 14/16<br>NK 14/20             |
|                      | 22 | 13 | 7,37               | 8,15   | 0,95                        | 13 000          | 12 000         | 0,016  |                                                                             |
|                      | 22 | 13 | 7,37               | 8,15   | 0,95                        | –               | 12 000         | 0,016  |                                                                             |
|                      | 22 | 16 | 10,2               | 12,5   | 1,53                        | 24 000          | 28 000         | 0,021  |                                                                             |
|                      | 22 | 20 | 12,8               | 16,6   | 2,08                        | 24 000          | 28 000         | 0,026  |                                                                             |
| 15                   | 23 | 16 | 11                 | 14     | 1,7                         | 24 000          | 26 000         | 0,022  | NK 15/16<br>NK 15/20                                                        |
|                      | 23 | 20 | 13,8               | 18,3   | 2,28                        | 24 000          | 26 000         | 0,027  |                                                                             |
| 16                   | 24 | 13 | 9,9                | 12,2   | 1,46                        | 22 000          | 26 000         | 0,017  | RNA 4901<br>RNA 4901 RS<br>RNA 4901.2RS<br>NK 16/16<br>NK 16/20<br>RNA 6901 |
|                      | 24 | 13 | 8,09               | 9,65   | 1,14                        | 22 000          | 11 000         | 0,018  |                                                                             |
|                      | 24 | 13 | 8,09               | 9,65   | 1,14                        | –               | 11 000         | 0,018  |                                                                             |
|                      | 24 | 16 | 11,7               | 15,3   | 1,86                        | 22 000          | 26 000         | 0,022  |                                                                             |
|                      | 24 | 20 | 14,5               | 20     | 2,5                         | 22 000          | 26 000         | 0,028  |                                                                             |
|                      | 24 | 22 | 16,1               | 23,2   | 2,9                         | 22 000          | 26 000         | 0,031  |                                                                             |

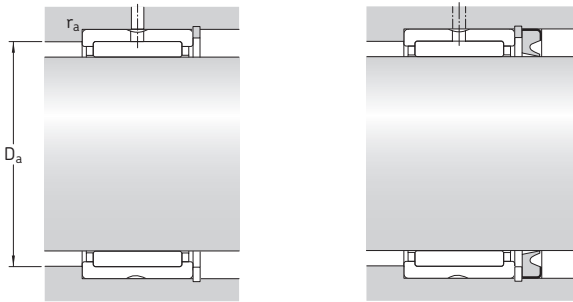

| Dimensions     |                         | Abutment and fillet dimensions |                       | Appropriate seal <sup>1)</sup> |
|----------------|-------------------------|--------------------------------|-----------------------|--------------------------------|
| F <sub>w</sub> | r <sub>1,2</sub><br>min | D <sub>a</sub><br>max          | r <sub>a</sub><br>max | Designation                    |
| mm             |                         | mm                             |                       | –                              |
| 5              | 0,15                    | 8,8                            | 0,1                   | G 5×10×2 S                     |
|                | 0,15                    | 8,8                            | 0,1                   | G 5×10×2 S                     |
| 6              | 0,15                    | 10,8                           | 0,1                   | G 6×12×2 S                     |
|                | 0,15                    | 10,8                           | 0,1                   | G 6×12×2 S                     |
| 7              | 0,3                     | 12                             | 0,3                   | G 7×14×2                       |
|                | 0,3                     | 12                             | 0,3                   | G 7×14×2                       |
| 8              | 0,3                     | 13                             | 0,3                   | G/SD 8×15×3                    |
|                | 0,3                     | 13                             | 0,3                   | G/SD 8×15×3                    |
| 9              | 0,3                     | 14                             | 0,3                   | G 9×16×3                       |
|                | 0,3                     | 14                             | 0,3                   | G 9×16×3                       |
| 10             | 0,3                     | 15                             | 0,3                   | G/SD 10×17×3                   |
|                | 0,3                     | 15                             | 0,3                   | G/SD 10×17×3                   |
| 12             | 0,3                     | 17                             | 0,3                   | G/SD 12×19×3                   |
|                | 0,3                     | 17                             | 0,3                   | G/SD 12×19×3                   |
| 14             | 0,3                     | 20                             | 0,3                   | G/SD 14×22×3                   |
|                | 0,3                     | 20                             | 0,3                   | –                              |
|                | 0,3                     | 20                             | 0,3                   | –                              |
|                | 0,3                     | 20                             | 0,3                   | G/SD 14×22×3                   |
|                | 0,3                     | 20                             | 0,3                   | G/SD 14×22×3                   |
| 15             | 0,3                     | 21                             | 0,3                   | G/SD 15×23×3                   |
|                | 0,3                     | 21                             | 0,3                   | G/SD 15×23×3                   |
| 16             | 0,3                     | 22                             | 0,3                   | G/SD 16×24×3                   |
|                | 0,3                     | 22                             | 0,3                   | –                              |
|                | 0,3                     | 22                             | 0,3                   | –                              |
|                | 0,3                     | 22                             | 0,3                   | G/SD 16×24×3                   |
|                | 0,3                     | 22                             | 0,3                   | G/SD 16×24×3                   |
|                | 0,3                     | 22                             | 0,3                   | G/SD 16×24×3                   |

<sup>1)</sup> For additional information, refer to the section *Radial shaft seals with a low cross sectional height*, starting on **page 208**.  
For additional information about SKF seals, refer to the SKF catalogue *Industrial shaft seals*.

**Needle roller bearings with machined rings with flanges, without an inner ring**  
**F<sub>w</sub> 17 – 24 mm**

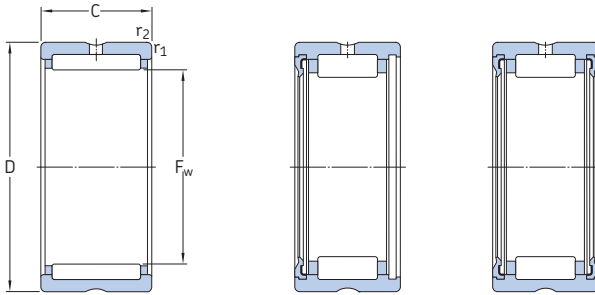

NK(S)  
RNA 49  
RNA 69

RNA 49.. RS

RNA 49...2RS

| Principal dimensions |    |    | Basic load ratings |                | Fatigue load limit<br>P <sub>u</sub> | Speed ratings   |                | Mass  | Designation         |
|----------------------|----|----|--------------------|----------------|--------------------------------------|-----------------|----------------|-------|---------------------|
| F <sub>w</sub>       | D  | C  | dynamic            | static         |                                      | Reference speed | Limiting speed |       |                     |
| mm                   |    |    | C                  | C <sub>0</sub> | kN                                   | r/min           | kg             | –     |                     |
| <b>17</b>            | 25 | 16 | 12,1               | 16,6           | 2                                    | 22 000          | 26 000         | 0,024 | <b>NK 17/16</b>     |
|                      | 25 | 20 | 15,1               | 22             | 2,75                                 | 22 000          | 26 000         | 0,030 | <b>NK 17/20</b>     |
| <b>18</b>            | 26 | 16 | 12,8               | 17,6           | 2,16                                 | 22 000          | 24 000         | 0,025 | <b>NK 18/16</b>     |
|                      | 26 | 20 | 16,1               | 23,6           | 3                                    | 22 000          | 24 000         | 0,031 | <b>NK 18/20</b>     |
| <b>19</b>            | 27 | 16 | 13,4               | 19             | 2,32                                 | 20 000          | 24 000         | 0,026 | <b>NK 19/16</b>     |
|                      | 27 | 20 | 16,5               | 25,5           | 3,2                                  | 20 000          | 24 000         | 0,032 | <b>NK 19/20</b>     |
| <b>20</b>            | 28 | 13 | 11,2               | 15,3           | 1,83                                 | 19 000          | 22 000         | 0,022 | <b>RNA 4902</b>     |
|                      | 28 | 13 | 9,13               | 12             | 1,4                                  | 19 000          | 9 500          | 0,022 | <b>RNA 4902 RS</b>  |
|                      | 28 | 13 | 9,13               | 12             | 1,4                                  | –               | 9 500          | 0,022 | <b>RNA 4902.2RS</b> |
|                      | 28 | 16 | 13,2               | 19,3           | 2,36                                 | 19 000          | 22 000         | 0,027 | <b>NK 20/16</b>     |
|                      | 28 | 20 | 16,5               | 25,5           | 3,2                                  | 19 000          | 22 000         | 0,034 | <b>NK 20/20</b>     |
|                      | 32 | 20 | 23,3               | 27             | 3,45                                 | 18 000          | 20 000         | 0,049 | <b>NKS 20</b>       |
|                      | 28 | 23 | 17,2               | 27             | 3,4                                  | 19 000          | 22 000         | 0,040 | <b>RNA 6902</b>     |
| <b>21</b>            | 29 | 16 | 13,8               | 20,4           | 2,5                                  | 19 000          | 22 000         | 0,028 | <b>NK 21/16</b>     |
|                      | 29 | 20 | 17,2               | 27             | 3,45                                 | 19 000          | 22 000         | 0,035 | <b>NK 21/20</b>     |
| <b>22</b>            | 30 | 13 | 11,4               | 16,3           | 1,96                                 | 18 000          | 20 000         | 0,022 | <b>RNA 4903</b>     |
|                      | 30 | 13 | 9,52               | 12,9           | 1,5                                  | 18 000          | 9 000          | 0,023 | <b>RNA 4903 RS</b>  |
|                      | 30 | 13 | 9,52               | 12,9           | 1,5                                  | –               | 9 000          | 0,023 | <b>RNA 4903.2RS</b> |
|                      | 30 | 16 | 14,2               | 21,6           | 2,65                                 | 18 000          | 20 000         | 0,030 | <b>NK 22/16</b>     |
|                      | 30 | 20 | 17,9               | 29             | 3,65                                 | 18 000          | 20 000         | 0,037 | <b>NK 22/20</b>     |
|                      | 30 | 23 | 18,7               | 30,5           | 3,9                                  | 18 000          | 20 000         | 0,042 | <b>RNA 6903</b>     |
|                      | 35 | 20 | 24,6               | 30             | 3,9                                  | 16 000          | 19 000         | 0,062 | <b>NKS 22</b>       |
| <b>24</b>            | 32 | 16 | 15,4               | 24,5           | 3                                    | 16 000          | 19 000         | 0,032 | <b>NK 24/16</b>     |
|                      | 32 | 20 | 19                 | 32,5           | 4,05                                 | 16 000          | 19 000         | 0,040 | <b>NK 24/20</b>     |
|                      | 37 | 20 | 26                 | 33,5           | 4,25                                 | 15 000          | 17 000         | 0,066 | <b>NKS 24</b>       |

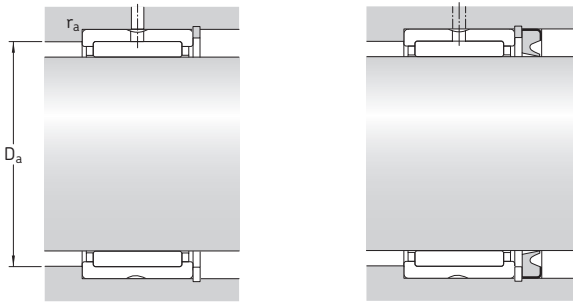

| Dimensions     |                         | Abutment and fillet dimensions |                       | Appropriate seal <sup>1)</sup> |
|----------------|-------------------------|--------------------------------|-----------------------|--------------------------------|
| F <sub>w</sub> | r <sub>1,2</sub><br>min | D <sub>a</sub><br>max          | r <sub>a</sub><br>max | Designation                    |
| mm             |                         | mm                             |                       | –                              |
| 17             | 0,3                     | 23                             | 0,3                   | G/SD 17×25×3                   |
|                | 0,3                     | 23                             | 0,3                   | G/SD 17×25×3                   |
| 18             | 0,3                     | 24                             | 0,3                   | G/SD 18×26×4                   |
|                | 0,3                     | 24                             | 0,3                   | G/SD 18×26×4                   |
| 19             | 0,3                     | 25                             | 0,3                   | G/SD 19×27×4                   |
|                | 0,3                     | 25                             | 0,3                   | G/SD 19×27×4                   |
| 20             | 0,3                     | 26                             | 0,3                   | G/SD 20×28×4                   |
|                | 0,3                     | 26                             | 0,3                   | –                              |
|                | 0,3                     | 26                             | 0,3                   | –                              |
|                | 0,3                     | 26                             | 0,3                   | G/SD 20×28×4                   |
|                | 0,3                     | 26                             | 0,3                   | G/SD 20×28×4                   |
|                | 0,6                     | 28                             | 0,6                   | CR 20×32×7 CRW1 R              |
|                | 0,3                     | 26                             | 0,3                   | G/SD 20×28×4                   |
| 21             | 0,3                     | 27                             | 0,3                   | G 21×29×4                      |
|                | 0,3                     | 27                             | 0,3                   | G 21×29×4                      |
| 22             | 0,3                     | 28                             | 0,3                   | G/SD 22×30×4                   |
|                | 0,3                     | 28                             | 0,3                   | –                              |
|                | 0,3                     | 28                             | 0,3                   | –                              |
|                | 0,3                     | 28                             | 0,3                   | G/SD 22×30×4                   |
|                | 0,3                     | 28                             | 0,3                   | G/SD 22×30×4                   |
|                | 0,3                     | 28                             | 0,3                   | G/SD 22×30×4                   |
|                | 0,6                     | 31                             | 0,6                   | CR 22×35×7 CRW1 R              |
| 24             | 0,3                     | 30                             | 0,3                   | G/SD 24×32×4                   |
|                | 0,3                     | 30                             | 0,3                   | G/SD 24×32×4                   |
|                | 0,6                     | 33                             | 0,6                   | –                              |

<sup>1)</sup> For additional information, refer to the section *Radial shaft seals with a low cross sectional height*, starting on **page 208**.  
For additional information about SKF seals, refer to the SKF catalogue *Industrial shaft seals*.

## Needle roller bearings with machined rings with flanges, without an inner ring F<sub>w</sub> 25 – 32 mm

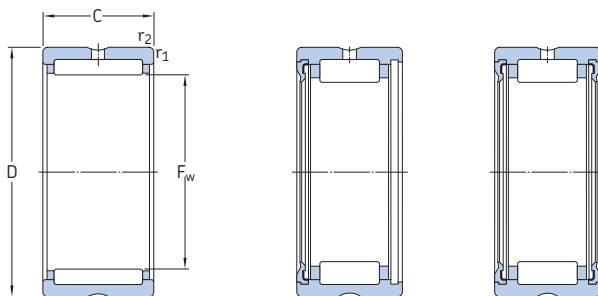

NK(S)  
RNA 49  
RNA 69

RNA 49..RS

RNA 49...2RS

| Principal dimensions |    |    | Basic load ratings |                | Fatigue load limit<br>P <sub>u</sub> | Speed ratings   |                | Mass  | Designation         |
|----------------------|----|----|--------------------|----------------|--------------------------------------|-----------------|----------------|-------|---------------------|
| F <sub>w</sub>       | D  | C  | dynamic            | static         |                                      | Reference speed | Limiting speed |       |                     |
| mm                   |    |    | C                  | C <sub>0</sub> | kN                                   | r/min           | kg             | –     |                     |
| <b>25</b>            | 33 | 16 | 15,1               | 24,5           | 3                                    | 16 000          | 18 000         | 0,033 | <b>NK 25/16</b>     |
|                      | 33 | 20 | 19                 | 32,5           | 4,15                                 | 16 000          | 18 000         | 0,042 | <b>NK 25/20</b>     |
|                      | 37 | 17 | 21,6               | 28             | 3,55                                 | 15 000          | 17 000         | 0,052 | <b>RNA 4904</b>     |
|                      | 37 | 17 | 19,4               | 22,4           | 2,75                                 | 15 000          | 7 500          | 0,056 | <b>RNA 4904 RS</b>  |
|                      | 37 | 17 | 19,4               | 22,4           | 2,75                                 | –               | 7 500          | 0,056 | <b>RNA 4904.2RS</b> |
|                      | 37 | 30 | 35,2               | 53             | 6,95                                 | 15 000          | 17 000         | 0,10  | <b>RNA 6904</b>     |
|                      | 38 | 20 | 27,5               | 36             | 4,55                                 | 15 000          | 17 000         | 0,068 | <b>NKS 25</b>       |
| <b>26</b>            | 34 | 16 | 15,7               | 26             | 3,2                                  | 15 000          | 17 000         | 0,034 | <b>NK 26/16</b>     |
|                      | 34 | 20 | 19,4               | 34,5           | 4,3                                  | 15 000          | 17 000         | 0,042 | <b>NK 26/20</b>     |
| <b>28</b>            | 37 | 20 | 22                 | 36,5           | 4,65                                 | 14 000          | 16 000         | 0,052 | <b>NK 28/20</b>     |
|                      | 37 | 30 | 31,9               | 60             | 7,8                                  | 14 000          | 16 000         | 0,082 | <b>NK 28/30</b>     |
|                      | 39 | 17 | 23,3               | 32             | 4,05                                 | 14 000          | 15 000         | 0,050 | <b>RNA 49/22</b>    |
|                      | 39 | 30 | 36,9               | 57             | 7,5                                  | 14 000          | 15 000         | 0,098 | <b>RNA 69/22</b>    |
|                      | 42 | 20 | 28,6               | 39             | 5                                    | 13 000          | 15 000         | 0,084 | <b>NKS 28</b>       |
| <b>29</b>            | 38 | 20 | 24,6               | 42,5           | 5,2                                  | 14 000          | 15 000         | 0,050 | <b>NK 29/20 TN</b>  |
|                      | 38 | 30 | 31,9               | 60             | 7,8                                  | 14 000          | 15 000         | 0,084 | <b>NK 29/30</b>     |
| <b>30</b>            | 40 | 20 | 25,5               | 44             | 5,5                                  | 13 000          | 15 000         | 0,061 | <b>NK 30/20 TN</b>  |
|                      | 40 | 30 | 36,9               | 72             | 9                                    | 13 000          | 15 000         | 0,093 | <b>NK 30/30 TN</b>  |
|                      | 42 | 17 | 24,2               | 34,5           | 4,3                                  | 13 000          | 15 000         | 0,061 | <b>RNA 4905</b>     |
|                      | 42 | 17 | 21,6               | 27,5           | 3,35                                 | 13 000          | 6 300          | 0,060 | <b>RNA 4905 RS</b>  |
|                      | 42 | 17 | 21,6               | 27,5           | 3,35                                 | –               | 6 300          | 0,060 | <b>RNA 4905.2RS</b> |
|                      | 42 | 30 | 38                 | 62             | 8,15                                 | 13 000          | 15 000         | 0,11  | <b>RNA 6905</b>     |
|                      | 45 | 22 | 31,9               | 43             | 5,5                                  | 12 000          | 14 000         | 0,10  | <b>NKS 30</b>       |
| <b>32</b>            | 42 | 20 | 26,4               | 48             | 6                                    | 12 000          | 14 000         | 0,064 | <b>NK 32/20 TN</b>  |
|                      | 42 | 30 | 34,1               | 65,5           | 8,65                                 | 12 000          | 14 000         | 0,10  | <b>NK 32/30</b>     |
|                      | 45 | 17 | 25,1               | 36,5           | 4,55                                 | 12 000          | 14 000         | 0,073 | <b>RNA 49/28</b>    |
|                      | 45 | 30 | 39,6               | 65,5           | 8,65                                 | 12 000          | 14 000         | 0,14  | <b>RNA 69/28</b>    |
|                      | 47 | 22 | 34,1               | 46,5           | 6                                    | 12 000          | 14 000         | 0,11  | <b>NKS 32</b>       |



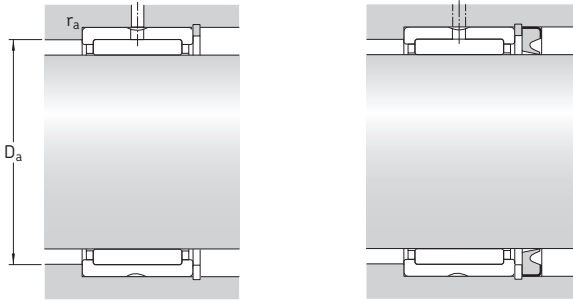

| Dimensions     |                         | Abutment and fillet dimensions |                       | Appropriate seal <sup>1)</sup><br>Designation |
|----------------|-------------------------|--------------------------------|-----------------------|-----------------------------------------------|
| F <sub>w</sub> | r <sub>1,2</sub><br>min | D <sub>a</sub><br>max          | r <sub>a</sub><br>max |                                               |
| mm             |                         | mm                             |                       | –                                             |
| 25             | 0,3                     | 31                             | 0,3                   | G/SD 25×33×4                                  |
|                | 0,3                     | 31                             | 0,3                   | G/SD 25×33×4                                  |
|                | 0,3                     | 35                             | 0,3                   | CR 25×35×7 CRW1 R                             |
|                | 0,3                     | 35                             | 0,3                   | –                                             |
|                | 0,3                     | 35                             | 0,3                   | –                                             |
|                | 0,3                     | 35                             | 0,3                   | CR 25×35×7 CRW1 R                             |
|                | 0,6                     | 34                             | 0,6                   | CR 25×38×7 CRW1 R                             |
| 26             | 0,3                     | 32                             | 0,3                   | G/SD 26×34×4                                  |
|                | 0,3                     | 32                             | 0,3                   | G/SD 26×34×4                                  |
| 28             | 0,3                     | 35                             | 0,3                   | G 28×37×4                                     |
|                | 0,3                     | 35                             | 0,3                   | G 28×37×4                                     |
|                | 0,3                     | 37                             | 0,3                   | –                                             |
|                | 0,3                     | 37                             | 0,3                   | –                                             |
|                | 0,6                     | 38                             | 0,6                   | CR 28×42×7 CRW1 R                             |
| 29             | 0,3                     | 36                             | 0,3                   | G 29×38×4                                     |
|                | 0,3                     | 36                             | 0,3                   | G 29×38×4                                     |
| 30             | 0,3                     | 38                             | 0,3                   | G/SD 30×40×4                                  |
|                | 0,3                     | 38                             | 0,3                   | G/SD 30×40×4                                  |
|                | 0,3                     | 40                             | 0,3                   | CR 30×42×7 CRW1 R                             |
|                | 0,3                     | 40                             | 0,3                   | –                                             |
|                | 0,3                     | 40                             | 0,3                   | –                                             |
|                | 0,6                     | 40                             | 0,3                   | CR 30×42×7 CRW1 R                             |
| 32             | 0,3                     | 41                             | 0,6                   | CR 30×45×8 CRW1 R                             |
|                | 0,3                     | 40                             | 0,3                   | G/SD 32×42×4                                  |
|                | 0,3                     | 40                             | 0,3                   | G/SD 32×42×4                                  |
|                | 0,3                     | 43                             | 0,3                   | G 32×45×4                                     |
|                | 0,3                     | 43                             | 0,3                   | G 32×45×4                                     |
|                | 0,3                     | 43                             | 0,3                   | G 32×45×4                                     |
|                | 0,6                     | 43                             | 0,6                   | CR 32×47×8 CRW1 R                             |

<sup>1)</sup> For additional information, refer to the section *Radial shaft seals with a low cross sectional height*, starting on page 208.  
For additional information about SKF seals, refer to the SKF catalogue *Industrial shaft seals*.

## Needle roller bearings with machined rings with flanges, without an inner ring

$F_w$  35 – 47 mm

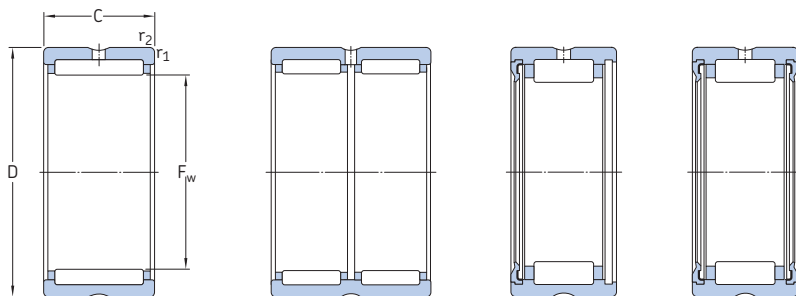

NK(S)  
RNA 49  
RNA 69 (D ≤ 47 mm)

RNA 69 (D ≥ 52 mm)

RNA 49..RS

RNA 49...2RS

| Principal dimensions |    |    | Basic load ratings |        | Fatigue load limit<br>$P_u$ | Speed ratings   |                | Mass  | Designation  |
|----------------------|----|----|--------------------|--------|-----------------------------|-----------------|----------------|-------|--------------|
| $F_w$                | D  | C  | dynamic            | static |                             | Reference speed | Limiting speed |       |              |
| mm                   |    |    | C                  | $C_0$  | kN                          | r/min           | kg             | –     |              |
| 35                   | 45 | 20 | 27,5               | 52     | 6,55                        | 11 000          | 13 000         | 0,070 | NK 35/20 TN  |
|                      | 45 | 30 | 40,2               | 85     | 10,6                        | 11 000          | 13 000         | 0,11  | NK 35/30 TN  |
|                      | 47 | 17 | 25,5               | 39     | 4,9                         | 11 000          | 13 000         | 0,069 | RNA 4906     |
|                      | 47 | 17 | 23,3               | 32     | 3,9                         | 11 000          | 5 600          | 0,069 | RNA 4906 RS  |
|                      | 47 | 17 | 23,3               | 32     | 3,9                         | –               | 5 600          | 0,069 | RNA 4906.2RS |
|                      | 47 | 30 | 42,9               | 75     | 9,8                         | 11 000          | 13 000         | 0,13  | RNA 4906     |
|                      | 50 | 22 | 35,2               | 50     | 6,4                         | 11 000          | 12 000         | 0,12  | NKS 35       |
| 37                   | 47 | 20 | 25,1               | 46,5   | 5,85                        | 11 000          | 12 000         | 0,077 | NK 37/20     |
|                      | 47 | 30 | 36,9               | 76,5   | 10                          | 11 000          | 12 000         | 0,11  | NK 37/30     |
|                      | 52 | 22 | 36,9               | 54     | 6,95                        | 10 000          | 12 000         | 0,12  | NKS 37       |
| 38                   | 48 | 20 | 25,5               | 49     | 6,2                         | 11 000          | 12 000         | 0,079 | NK 38/20     |
|                      | 48 | 30 | 37,4               | 80     | 10,4                        | 11 000          | 12 000         | 0,12  | NK 38/30     |
| 40                   | 50 | 20 | 30,3               | 61     | 7,5                         | 10 000          | 11 000         | 0,078 | NK 40/20 TN  |
|                      | 50 | 30 | 38                 | 83     | 10,8                        | 10 000          | 11 000         | 0,13  | NK 40/30     |
|                      | 52 | 20 | 30,8               | 51     | 6,55                        | 10 000          | 11 000         | 0,089 | RNA 49/32    |
|                      | 52 | 36 | 47,3               | 90     | 11,2                        | 10 000          | 11 000         | 0,16  | RNA 69/32    |
|                      | 55 | 22 | 38                 | 57     | 7,35                        | 9 500           | 11 000         | 0,13  | NKS 40       |
| 42                   | 52 | 20 | 27                 | 53     | 6,7                         | 9 500           | 11 000         | 0,086 | NK 42/20     |
|                      | 52 | 30 | 39,1               | 86,5   | 11,2                        | 9 500           | 11 000         | 0,13  | NK 42/30     |
|                      | 55 | 20 | 31,9               | 54     | 6,95                        | 9 500           | 11 000         | 0,11  | RNA 4907     |
|                      | 55 | 20 | 27                 | 43     | 5,4                         | 9 500           | 4 800          | 0,11  | RNA 4907 RS  |
|                      | 55 | 20 | 27                 | 43     | 5,4                         | –               | 4 800          | 0,11  | RNA 4907.2RS |
|                      | 55 | 36 | 48,4               | 93     | 11,8                        | 9 500           | 11 000         | 0,19  | RNA 6907     |
| 43                   | 53 | 20 | 27,5               | 55     | 6,95                        | 9 500           | 11 000         | 0,086 | NK 43/20     |
|                      | 53 | 30 | 40,2               | 90     | 11,6                        | 9 500           | 11 000         | 0,13  | NK 43/30     |
|                      | 58 | 22 | 39,1               | 61     | 7,8                         | 9 000           | 10 000         | 0,14  | NKS 43       |
| 45                   | 55 | 20 | 31,4               | 67     | 8,3                         | 9 000           | 10 000         | 0,086 | NK 45/20 TN  |
|                      | 55 | 30 | 45,7               | 108    | 13,4                        | 9 000           | 10 000         | 0,14  | NK 45/30 TN  |
|                      | 60 | 22 | 40,2               | 64     | 8,3                         | 8 500           | 10 000         | 0,15  | NKS 45       |
| 47                   | 57 | 20 | 29,2               | 61     | 7,65                        | 8 500           | 10 000         | 0,095 | NK 47/20     |
|                      | 57 | 30 | 41,8               | 98     | 12,9                        | 8 500           | 10 000         | 0,14  | NK 47/30     |

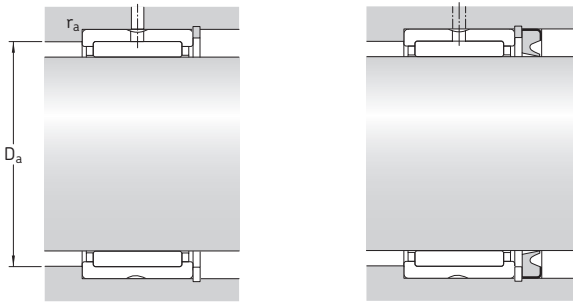

| Dimensions     |                         | Abutment and fillet dimensions |                       | Appropriate seal <sup>1)</sup><br>Designation |
|----------------|-------------------------|--------------------------------|-----------------------|-----------------------------------------------|
| F <sub>w</sub> | r <sub>1,2</sub><br>min | D <sub>a</sub><br>max          | r <sub>a</sub><br>max |                                               |
| mm             |                         | mm                             |                       | –                                             |
| 35             | 0,3                     | 43                             | 0,3                   | G/SD 35×45×4                                  |
|                | 0,3                     | 43                             | 0,3                   | G/SD 35×45×4                                  |
|                | 0,3                     | 45                             | 0,3                   | CR 35×47×7 CRW1 R                             |
|                | 0,3                     | 45                             | 0,3                   | –                                             |
|                | 0,3                     | 45                             | 0,3                   | –                                             |
|                | 0,6                     | 46                             | 0,6                   | CR 35×47×7 CRW1 R<br>CR 35×50×8 CRW1 R        |
| 37             | 0,3                     | 45                             | 0,3                   | G/SD 37×47×4                                  |
|                | 0,3                     | 45                             | 0,3                   | G/SD 37×47×4                                  |
|                | 0,6                     | 48                             | 0,6                   | –                                             |
| 38             | 0,3                     | 46                             | 0,3                   | G/SD 38×48×4                                  |
|                | 0,3                     | 46                             | 0,3                   | G/SD 38×48×4                                  |
| 40             | 0,3                     | 48                             | 0,3                   | G/SD 40×50×4                                  |
|                | 0,3                     | 48                             | 0,3                   | G/SD 40×50×4                                  |
|                | 0,6                     | 48                             | 0,6                   | G/SD 40×52×5                                  |
|                | 0,6                     | 48                             | 0,6                   | G/SD 40×52×5                                  |
|                | 0,6                     | 51                             | 0,6                   | CR 40×55×8 CRW1 R                             |
| 42             | 0,3                     | 50                             | 0,3                   | G/SD 42×52×4                                  |
|                | 0,3                     | 50                             | 0,3                   | G/SD 42×52×4                                  |
|                | 0,6                     | 51                             | 0,6                   | CR 42×55×8 CRW R                              |
|                | 0,6                     | 51                             | 0,6                   | –                                             |
|                | 0,6                     | 51                             | 0,6                   | –                                             |
|                | 0,6                     | 51                             | 0,6                   | –                                             |
| 43             | 0,3                     | 51                             | 0,3                   | G 43×53×4                                     |
|                | 0,3                     | 51                             | 0,3                   | G 43×53×4                                     |
|                | 0,6                     | 53                             | 0,6                   | –                                             |
| 45             | 0,3                     | 53                             | 0,3                   | G/SD 45×55×4                                  |
|                | 0,3                     | 53                             | 0,3                   | G/SD 45×55×4                                  |
|                | 0,6                     | 56                             | 0,6                   | CR 45×60×8 CRW1 R                             |
| 47             | 0,3                     | 55                             | 0,3                   | –                                             |
|                | 0,3                     | 55                             | 0,3                   | –                                             |

<sup>1)</sup> For additional information, refer to the section *Radial shaft seals with a low cross sectional height*, starting on **page 208**.  
For additional information about SKF seals, refer to the SKF catalogue *Industrial shaft seals*.

## Needle roller bearings with machined rings with flanges, without an inner ring

$F_w$  48 – 68 mm

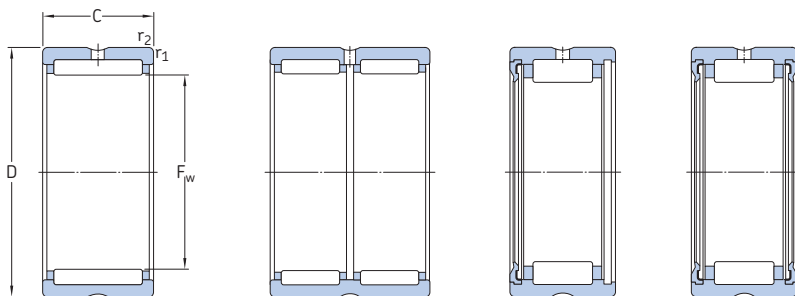

NK(S)  
RNA 49

RNA 69

RNA 49..RS

RNA 49...2RS

| Principal dimensions |    |    | Basic load ratings |       | Fatigue load limit<br>$P_u$ | Speed ratings   |                | Mass | Designation                                                                     |
|----------------------|----|----|--------------------|-------|-----------------------------|-----------------|----------------|------|---------------------------------------------------------------------------------|
| $F_w$                | D  | C  | C                  | $C_0$ |                             | Reference speed | Limiting speed |      |                                                                                 |
| mm                   |    |    | kN                 |       | kN                          | r/min           | kg             | –    |                                                                                 |
| <b>48</b>            | 62 | 22 | 42,9               | 71    | 9,15                        | 8 000           | 9 500          | 0,14 | <b>RNA 4908</b><br><b>RNA 4908 RS</b><br><b>RNA 4908.2RS</b><br><b>RNA 6908</b> |
|                      | 62 | 22 | 36,9               | 58,5  | 7,35                        | 8 000           | 4 000          | 0,15 |                                                                                 |
|                      | 62 | 22 | 36,9               | 58,5  | 7,35                        | –               | 4 000          | 0,15 |                                                                                 |
|                      | 62 | 40 | 67,1               | 125   | 16                          | 8 000           | 9 500          | 0,26 |                                                                                 |
| <b>50</b>            | 62 | 25 | 42,9               | 93    | 11,2                        | 8 000           | 9 000          | 0,15 | <b>NK 50/25 TN</b><br><b>NK 50/35 TN</b><br><b>NKS 50</b>                       |
|                      | 62 | 35 | 58,3               | 137   | 17                          | 8 000           | 9 000          | 0,21 |                                                                                 |
|                      | 65 | 22 | 42,9               | 72    | 9,15                        | 8 000           | 9 000          | 0,16 |                                                                                 |
| <b>52</b>            | 68 | 22 | 45,7               | 78    | 10                          | 7 500           | 8 500          | 0,18 | <b>RNA 4909</b><br><b>RNA 4909 RS</b><br><b>RNA 4909.2RS</b><br><b>RNA 6909</b> |
|                      | 68 | 22 | 39,1               | 64    | 8                           | 7 500           | 3 800          | 0,16 |                                                                                 |
|                      | 68 | 22 | 39,1               | 64    | 8                           | –               | 3 800          | 0,16 |                                                                                 |
|                      | 68 | 40 | 70,4               | 137   | 17,3                        | 7 500           | 8 500          | 0,34 |                                                                                 |
| <b>55</b>            | 68 | 25 | 40,2               | 88    | 11,2                        | 7 500           | 8 500          | 0,18 | <b>NK 55/25</b><br><b>NK 55/35</b><br><b>NKS 55</b>                             |
|                      | 68 | 35 | 52,3               | 122   | 16                          | 7 500           | 8 500          | 0,25 |                                                                                 |
|                      | 72 | 22 | 44,6               | 78    | 10                          | 7 000           | 8 000          | 0,22 |                                                                                 |
| <b>58</b>            | 72 | 22 | 47,3               | 85    | 11                          | 7 000           | 8 000          | 0,16 | <b>RNA 4910</b><br><b>RNA 4910 RS</b><br><b>RNA 4910.2RS</b><br><b>RNA 6910</b> |
|                      | 72 | 22 | 40,2               | 69,5  | 8,8                         | 7 000           | 3 400          | 0,16 |                                                                                 |
|                      | 72 | 22 | 40,2               | 69,5  | 8,8                         | –               | 3 400          | 0,16 |                                                                                 |
|                      | 72 | 40 | 73,7               | 150   | 19                          | 7 000           | 8 000          | 0,31 |                                                                                 |
| <b>60</b>            | 72 | 25 | 46,8               | 110   | 13,4                        | 6 700           | 7 500          | 0,17 | <b>NK 60/25 TN</b><br><b>NK 60/35</b><br><b>NKS 60</b>                          |
|                      | 72 | 35 | 55                 | 134   | 17,6                        | 6 700           | 7 500          | 0,26 |                                                                                 |
|                      | 80 | 28 | 62,7               | 104   | 13,7                        | 6 300           | 7 500          | 0,34 |                                                                                 |
| <b>63</b>            | 80 | 25 | 57,2               | 106   | 13,7                        | 6 300           | 7 000          | 0,26 | <b>RNA 4911</b><br><b>RNA 6911</b>                                              |
|                      | 80 | 45 | 89,7               | 190   | 24                          | 6 300           | 7 000          | 0,47 |                                                                                 |
| <b>65</b>            | 78 | 25 | 44                 | 104   | 13,2                        | 6 300           | 7 000          | 0,22 | <b>NK 65/25</b><br><b>NK 65/35</b><br><b>NKS 65</b>                             |
|                      | 78 | 35 | 58,3               | 146   | 19,3                        | 6 300           | 7 000          | 0,31 |                                                                                 |
|                      | 85 | 28 | 66                 | 114   | 15                          | 6 000           | 6 700          | 0,36 |                                                                                 |
| <b>68</b>            | 82 | 25 | 44                 | 95    | 12                          | 6 000           | 6 700          | 0,24 | <b>NK 68/25</b><br><b>NK 68/35</b><br><b>RNA 4912</b><br><b>RNA 6912</b>        |
|                      | 82 | 35 | 60,5               | 146   | 19                          | 6 000           | 6 700          | 0,34 |                                                                                 |
|                      | 85 | 25 | 60,5               | 114   | 14,6                        | 6 000           | 6 700          | 0,28 |                                                                                 |
|                      | 85 | 45 | 93,5               | 204   | 26                          | 6 000           | 6 700          | 0,49 |                                                                                 |

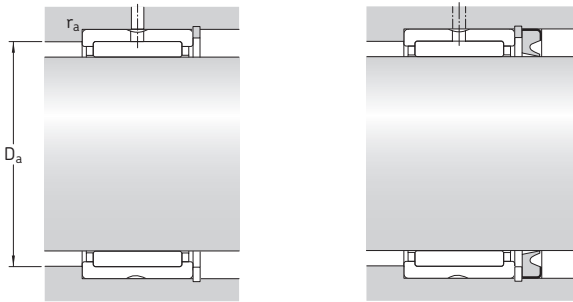

| Dimensions     |                         | Abutment and fillet dimensions |                       | Appropriate seal <sup>1)</sup><br>Designation |
|----------------|-------------------------|--------------------------------|-----------------------|-----------------------------------------------|
| F <sub>w</sub> | r <sub>1,2</sub><br>min | D <sub>a</sub><br>max          | r <sub>a</sub><br>max |                                               |
| mm             |                         | mm                             |                       | –                                             |
| 48             | 0,6                     | 58                             | 0,6                   | CR 48×62×8 CRW1 R                             |
|                | 0,6                     | 58                             | 0,6                   | –                                             |
|                | 0,6                     | 58                             | 0,6                   | –                                             |
|                | 0,6                     | 58                             | 0,6                   | –                                             |
| 50             | 0,6                     | 58                             | 0,6                   | G/SD 50×62×5                                  |
|                | 0,6                     | 58                             | 0,6                   | G/SD 50×62×5                                  |
|                | 1                       | 60                             | 1                     | CR 50×65×8 CRW1 R                             |
| 52             | 0,6                     | 64                             | 0,6                   | CR 52×68×8 CRW1 R                             |
|                | 0,6                     | 64                             | 0,6                   | –                                             |
|                | 0,6                     | 64                             | 0,6                   | –                                             |
|                | 0,6                     | 64                             | 0,6                   | –                                             |
| 55             | 0,6                     | 64                             | 0,6                   | –                                             |
|                | 0,6                     | 64                             | 0,6                   | –                                             |
|                | 1                       | 67                             | 1                     | CR 55×72×8 CRW1 R                             |
| 58             | 0,6                     | 68                             | 0,6                   | CR 58×72×8 CRW1 R                             |
|                | 0,6                     | 68                             | 0,6                   | –                                             |
|                | 0,6                     | 68                             | 0,6                   | –                                             |
|                | 0,6                     | 68                             | 0,6                   | –                                             |
| 60             | 0,6                     | 68                             | 0,6                   | –                                             |
|                | 0,6                     | 68                             | 0,6                   | –                                             |
|                | 1,1                     | 73,5                           | 1                     | –                                             |
| 63             | 1                       | 75                             | 1                     | CR 63×80×8 CRW1 R                             |
|                | 1                       | 75                             | 1                     | –                                             |
| 65             | 0,6                     | 74                             | 0,6                   | –                                             |
|                | 0,6                     | 74                             | 0,6                   | –                                             |
|                | 1,1                     | 78,5                           | 1                     | CR 65×85×8 CRW1 R                             |
| 68             | 0,6                     | 78                             | 0,6                   | –                                             |
|                | 0,6                     | 78                             | 0,6                   | –                                             |
|                | 1                       | 80                             | 1                     | CR 68×85×8 CRW1 R                             |
|                | 1                       | 80                             | 1                     | –                                             |

<sup>1)</sup> For additional information, refer to the section *Radial shaft seals with a low cross sectional height*, starting on **page 208**.  
For additional information about SKF seals, refer to the SKF catalogue *Industrial shaft seals*.

Needle roller bearings with machined rings with flanges, without an inner ring  
 $F_w$  70 – 100 mm

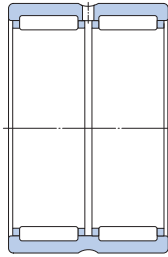
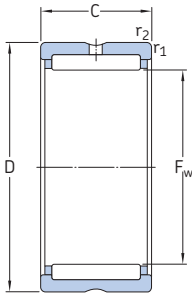

NK(S)  
RNA 49

RNA 69

| Principal dimensions |     |    | Basic load ratings |        | Fatigue load limit<br>$P_u$ | Speed ratings   |                | Mass | Designation |
|----------------------|-----|----|--------------------|--------|-----------------------------|-----------------|----------------|------|-------------|
| $F_w$                | D   | C  | dynamic            | static |                             | Reference speed | Limiting speed |      |             |
| mm                   |     |    | kN                 |        | kN                          | r/min           | kg             | –    |             |
| 70                   | 85  | 25 | 44,6               | 98     | 12,5                        | 6 000           | 6 700          | 0,26 | NK 70/25    |
|                      | 85  | 35 | 61,6               | 150    | 19,6                        | 6 000           | 6 700          | 0,37 | NK 70/35    |
|                      | 90  | 28 | 68,2               | 120    | 15,6                        | 5 600           | 6 300          | 0,38 | NKS 70      |
| 72                   | 90  | 25 | 61,6               | 120    | 15,3                        | 5 600           | 6 300          | 0,31 | RNA 4913    |
|                      | 90  | 45 | 95,2               | 212    | 27                          | 5 600           | 6 300          | 0,58 | RNA 6913    |
| 73                   | 90  | 25 | 52,8               | 106    | 13,7                        | 5 600           | 6 300          | 0,30 | NK 73/25    |
|                      | 90  | 35 | 73,7               | 163    | 21,6                        | 5 600           | 6 300          | 0,43 | NK 73/35    |
| 75                   | 92  | 25 | 53,9               | 110    | 14                          | 5 300           | 6 000          | 0,32 | NK 75/25    |
|                      | 92  | 35 | 74,8               | 170    | 22                          | 5 300           | 6 000          | 0,45 | NK 75/35    |
|                      | 95  | 28 | 70,4               | 132    | 17                          | 5 300           | 6 000          | 0,40 | NKS 75      |
| 80                   | 95  | 25 | 56,1               | 127    | 16                          | 5 000           | 5 600          | 0,30 | NK 80/25    |
|                      | 95  | 35 | 76,5               | 190    | 25                          | 5 000           | 5 600          | 0,43 | NK 80/35    |
|                      | 100 | 30 | 84,2               | 163    | 21,6                        | 5 000           | 5 600          | 0,46 | RNA 4914    |
|                      | 100 | 54 | 128                | 285    | 37,5                        | 5 000           | 5 600          | 0,86 | RNA 6914    |
| 85                   | 105 | 25 | 69,3               | 132    | 17                          | 4 800           | 5 300          | 0,43 | NK 85/25    |
|                      | 105 | 30 | 84,2               | 170    | 22,4                        | 4 800           | 5 300          | 0,49 | RNA 4915    |
|                      | 105 | 35 | 96,8               | 200    | 27                          | 4 800           | 5 300          | 0,60 | NK 85/35    |
|                      | 105 | 54 | 130                | 290    | 38                          | 4 800           | 5 300          | 0,94 | RNA 6915    |
| 90                   | 110 | 25 | 72,1               | 140    | 18,3                        | 4 500           | 5 000          | 0,45 | NK 90/25    |
|                      | 110 | 30 | 88                 | 183    | 24                          | 4 500           | 5 000          | 0,52 | RNA 4916    |
|                      | 110 | 35 | 101                | 216    | 29                          | 4 500           | 5 000          | 0,63 | NK 90/35    |
|                      | 110 | 54 | 134                | 315    | 41,5                        | 4 500           | 5 000          | 0,99 | RNA 6916    |
| 95                   | 115 | 26 | 73,7               | 146    | 19                          | 4 300           | 4 800          | 0,49 | NK 95/26    |
|                      | 115 | 36 | 105                | 232    | 30,5                        | 4 300           | 4 800          | 0,68 | NK 95/36    |
| 100                  | 120 | 26 | 76,5               | 156    | 19,6                        | 4 000           | 4 500          | 0,52 | NK 100/26   |
|                      | 120 | 35 | 108                | 250    | 32                          | 4 000           | 4 500          | 0,66 | RNA 4917    |
|                      | 120 | 36 | 108                | 250    | 32                          | 4 000           | 4 500          | 0,72 | NK 100/36   |
|                      | 120 | 63 | 165                | 425    | 54                          | 4 000           | 4 500          | 1,20 | RNA 6917    |

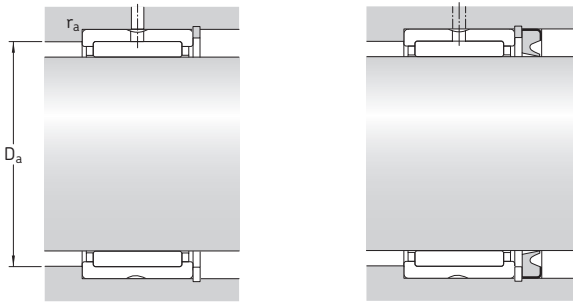

| Dimensions     |                         | Abutment and fillet dimensions |                       | Appropriate seal <sup>1)</sup> |
|----------------|-------------------------|--------------------------------|-----------------------|--------------------------------|
| F <sub>w</sub> | r <sub>1,2</sub><br>min | D <sub>a</sub><br>max          | r <sub>a</sub><br>max | Designation                    |
| mm             |                         | mm                             |                       | –                              |
| 70             | 0,6                     | 81                             | 0,6                   | CR 70×85×8 CRW1 R              |
|                | 0,6                     | 81                             | 0,6                   | CR 70×85×8 CRW1 R              |
|                | 1,1                     | 83,5                           | 1                     | CR 70×95×10 CRW1 R             |
| 72             | 1                       | 85                             | 1                     | CR 72×90×10 CRSH1 R            |
|                | 1                       | 85                             | 1                     | –                              |
| 73             | 1                       | 85                             | 1                     | –                              |
|                | 1                       | 85                             | 1                     | –                              |
| 75             | 1                       | 87                             | 1                     | –                              |
|                | 1                       | 87                             | 1                     | –                              |
|                | 1,1                     | 88,5                           | 1                     | CR 75×95×10 CRW1 R             |
| 80             | 1                       | 90                             | 1                     | –                              |
|                | 1                       | 90                             | 1                     | –                              |
|                | 1                       | 95                             | 1                     | CR 80×100×10 CRW1 R            |
|                | 1                       | 95                             | 1                     | –                              |
| 85             | 1                       | 100                            | 1                     | CR 85×105×10 CRW1 R            |
|                | 1                       | 100                            | 1                     | CR 85×105×10 CRW1 R            |
|                | 1                       | 100                            | 1                     | CR 85×105×10 CRW1 R            |
|                | 1                       | 100                            | 1                     | –                              |
| 90             | 1                       | 105                            | 1                     | CR 90×110×12 CRW1 R            |
|                | 1                       | 105                            | 1                     | CR 90×110×12 CRW1 R            |
|                | 1                       | 105                            | 1                     | CR 90×110×12 CRW1 R            |
|                | 1                       | 105                            | 1                     | –                              |
| 95             | 1                       | 110                            | 1                     | CR 95×115×12 CRW1 R            |
|                | 1                       | 110                            | 1                     | CR 95×115×12 CRW1 R            |
| 100            | 1                       | 115                            | 1                     | CR 100×120×12 CRW1 R           |
|                | 1,1                     | 113,5                          | 1                     | CR 100×120×12 CRW1 R           |
|                | 1                       | 115                            | 1                     | CR 100×120×12 CRW1 R           |
|                | 1,1                     | 113,5                          | 1                     | –                              |

<sup>1)</sup> For additional information, refer to the section *Radial shaft seals with a low cross sectional height*, starting on **page 208**.  
For additional information about SKF seals, refer to the SKF catalogue *Industrial shaft seals*.

## Needle roller bearings with machined rings with flanges, without an inner ring

$F_w$  105 – 210 mm

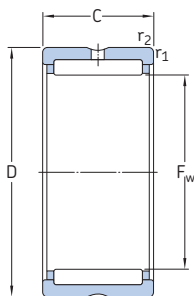

NK  
RNA 48  
RNA 49

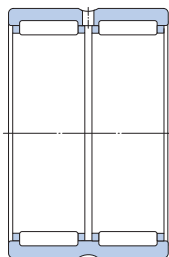

RNA 69

| Principal dimensions |     |    | Basic load ratings |        | Fatigue load limit<br>$P_u$ | Speed ratings   |                | Mass | Designation                                                                |
|----------------------|-----|----|--------------------|--------|-----------------------------|-----------------|----------------|------|----------------------------------------------------------------------------|
| $F_w$                | D   | C  | dynamic            | static |                             | Reference speed | Limiting speed |      |                                                                            |
| mm                   |     |    | kN                 | $C_0$  | kN                          | r/min           | kg             | –    |                                                                            |
| <b>105</b>           | 125 | 26 | 78,1               | 166    | 20,8                        | 3 800           | 4 300          | 0,54 | <b>NK 105/26</b><br><b>RNA 4918</b><br><b>NK 105/36</b><br><b>RNA 6918</b> |
|                      | 125 | 35 | 112                | 265    | 33,5                        | 3 800           | 4 300          | 0,75 |                                                                            |
|                      | 125 | 36 | 112                | 265    | 33,5                        | 3 800           | 4 300          | 0,71 |                                                                            |
|                      | 125 | 63 | 172                | 450    | 57                          | 3 800           | 4 300          | 1,35 |                                                                            |
| <b>110</b>           | 130 | 30 | 96,8               | 220    | 27,5                        | 3 600           | 4 000          | 0,65 | <b>NK 110/30</b><br><b>RNA 4919</b><br><b>NK 110/40</b><br><b>RNA 6919</b> |
|                      | 130 | 35 | 114                | 270    | 34                          | 3 600           | 4 000          | 0,72 |                                                                            |
|                      | 130 | 40 | 123                | 305    | 38                          | 3 600           | 4 000          | 0,83 |                                                                            |
|                      | 130 | 63 | 172                | 465    | 57                          | 3 600           | 4 000          | 1,45 |                                                                            |
| <b>115</b>           | 140 | 40 | 125                | 280    | 34,5                        | 3 400           | 4 000          | 1,15 | <b>RNA 4920</b>                                                            |
| <b>120</b>           | 140 | 30 | 93,5               | 232    | 27,5                        | 3 400           | 3 800          | 0,67 | <b>RNA 4822</b>                                                            |
| <b>125</b>           | 150 | 40 | 130                | 300    | 36,5                        | 3 200           | 3 600          | 1,25 | <b>RNA 4922</b>                                                            |
| <b>130</b>           | 150 | 30 | 99                 | 255    | 30                          | 3 200           | 3 600          | 0,73 | <b>RNA 4824</b>                                                            |
| <b>135</b>           | 165 | 45 | 176                | 405    | 47,5                        | 3 000           | 3 400          | 1,85 | <b>RNA 4924</b>                                                            |
| <b>145</b>           | 165 | 35 | 119                | 325    | 37,5                        | 2 800           | 3 200          | 0,99 | <b>RNA 4826</b>                                                            |
| <b>150</b>           | 180 | 50 | 198                | 480    | 55                          | 2 600           | 3 000          | 2,20 | <b>RNA 4926</b>                                                            |
| <b>155</b>           | 175 | 35 | 121                | 345    | 38                          | 2 600           | 3 000          | 1,05 | <b>RNA 4828</b>                                                            |
| <b>160</b>           | 190 | 50 | 205                | 510    | 58,5                        | 2 400           | 2 800          | 2,35 | <b>RNA 4928</b>                                                            |
| <b>165</b>           | 190 | 40 | 147                | 415    | 46,5                        | 2 400           | 2 800          | 1,60 | <b>RNA 4830</b>                                                            |
| <b>175</b>           | 200 | 40 | 157                | 450    | 50                          | 2 200           | 2 600          | 1,70 | <b>RNA 4832</b>                                                            |
| <b>185</b>           | 215 | 45 | 179                | 520    | 57                          | 2 200           | 2 400          | 2,55 | <b>RNA 4834</b>                                                            |
| <b>195</b>           | 225 | 45 | 190                | 570    | 60                          | 2 000           | 2 400          | 2,70 | <b>RNA 4836</b>                                                            |
| <b>210</b>           | 240 | 50 | 220                | 710    | 73,5                        | 1 900           | 2 200          | 3,20 | <b>RNA 4838</b>                                                            |



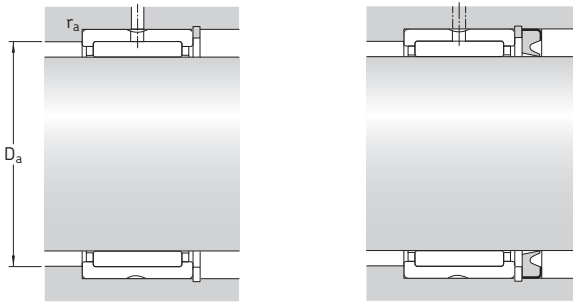

| Dimensions     |                      | Abutment and fillet dimensions |                    | Appropriate seal <sup>1)</sup> |
|----------------|----------------------|--------------------------------|--------------------|--------------------------------|
| F <sub>w</sub> | r <sub>1,2</sub> min | D <sub>a</sub> max             | r <sub>a</sub> max | Designation                    |
| mm             |                      | mm                             |                    | –                              |
| <b>105</b>     | 1                    | 120                            | 1                  | –                              |
|                | 1,1                  | 118,5                          | 1                  | –                              |
|                | 1                    | 120                            | 1                  | –                              |
|                | 1,1                  | 118,5                          | 1                  | –                              |
| <b>110</b>     | 1,1                  | 123,5                          | 1                  | CR 110×130×12 CRW1 R           |
|                | 1,1                  | 123,5                          | 1                  | –                              |
|                | 1,1                  | 123,5                          | 1                  | CR 110×130×12 CRW1 R           |
|                | 1,1                  | 123,5                          | 1                  | –                              |
| <b>115</b>     | 1,1                  | 133,5                          | 1                  | CR 115×140×12 CRW1 R           |
| <b>120</b>     | 1                    | 135                            | 1                  | CR 120×140×13 HMS4 R           |
| <b>125</b>     | 1,1                  | 143,5                          | 1                  | CR 125×150×12 CRW1 R           |
| <b>130</b>     | 1                    | 145                            | 1                  | –                              |
| <b>135</b>     | 1,1                  | 158,5                          | 1                  | –                              |
| <b>145</b>     | 1,1                  | 158,5                          | 1                  | CR 145×165×13 CRSH1 R          |
| <b>150</b>     | 1,5                  | 172                            | 1,5                | CR 150×180×12 HMS4 R           |
| <b>155</b>     | 1,1                  | 168,5                          | 1                  | –                              |
| <b>160</b>     | 1,5                  | 182                            | 1,5                | CR 160×190×15 CRW1 V           |
| <b>165</b>     | 1,1                  | 183,5                          | 1                  | –                              |
| <b>175</b>     | 1,1                  | 193,5                          | 1                  | –                              |
| <b>185</b>     | 1,1                  | 208,5                          | 1                  | –                              |
| <b>195</b>     | 1,1                  | 218,5                          | 1                  | –                              |
| <b>210</b>     | 1,5                  | 232                            | 1,5                | –                              |

<sup>1)</sup> For additional information, refer to the section *Radial shaft seals with a low cross sectional height*, starting on **page 208**.  
For additional information about SKF seals, refer to the SKF catalogue *Industrial shaft seals*.

Needle roller bearings with machined rings with flanges, without an inner ring  
 $F_w$  220 – 415 mm

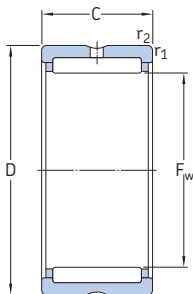

RNA 48

| Principal dimensions |     |     | Basic load ratings |                 | Fatigue load limit<br>$P_u$ | Speed ratings   |                | Mass | Designation     |
|----------------------|-----|-----|--------------------|-----------------|-----------------------------|-----------------|----------------|------|-----------------|
| $F_w$                | D   | C   | dynamic            | static<br>$C_0$ |                             | Reference speed | Limiting speed |      |                 |
| mm                   |     |     | kN                 |                 | kN                          | r/min           |                | kg   | –               |
| <b>220</b>           | 250 | 50  | 224                | 735             | 75                          | 1 800           | 2 000          | 3,35 | <b>RNA 4840</b> |
| <b>240</b>           | 270 | 50  | 238                | 815             | 81,5                        | 1 700           | 1 900          | 3,60 | <b>RNA 4844</b> |
| <b>265</b>           | 300 | 60  | 347                | 1 120           | 108                         | 1 500           | 1 700          | 5,40 | <b>RNA 4848</b> |
| <b>285</b>           | 320 | 60  | 358                | 1 200           | 114                         | 1 400           | 1 500          | 5,80 | <b>RNA 4852</b> |
| <b>305</b>           | 350 | 69  | 429                | 1 320           | 127                         | 1 300           | 1 400          | 9,30 | <b>RNA 4856</b> |
| <b>330</b>           | 380 | 80  | 594                | 1 800           | 170                         | 1 100           | 1 300          | 12,5 | <b>RNA 4860</b> |
| <b>350</b>           | 400 | 80  | 605                | 1 900           | 176                         | 1 100           | 1 200          | 13,5 | <b>RNA 4864</b> |
| <b>370</b>           | 420 | 80  | 616                | 1 960           | 180                         | 1 000           | 1 200          | 14,0 | <b>RNA 4868</b> |
| <b>390</b>           | 440 | 80  | 627                | 2 040           | 186                         | 950             | 1 100          | 15,0 | <b>RNA 4872</b> |
| <b>415</b>           | 480 | 100 | 968                | 3 000           | 265                         | 900             | 1 000          | 26,0 | <b>RNA 4876</b> |

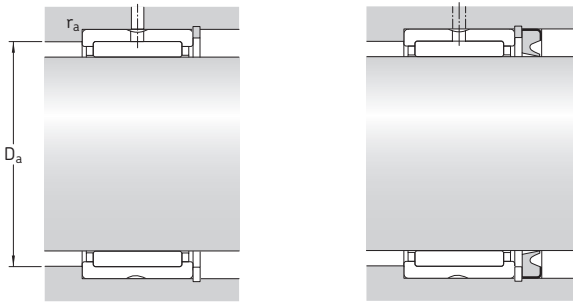

| Dimensions |                  | Abutment and fillet dimensions |              | Appropriate seal <sup>1)</sup><br>Designation |
|------------|------------------|--------------------------------|--------------|-----------------------------------------------|
| $F_w$      | $r_{1,2}$<br>min | $D_a$<br>max                   | $r_a$<br>max |                                               |
| mm         |                  | mm                             |              | –                                             |
| 220        | 1,5              | 242                            | 1,5          | CR 220×250×15 HMS4 R                          |
| 240        | 1,5              | 262                            | 1,5          | CR 240×270×16 HDS1 R                          |
| 265        | 2                | 291                            | 2            | –                                             |
| 285        | 2                | 311                            | 2            | –                                             |
| 305        | 2                | 341                            | 2            | –                                             |
| 330        | 2,1              | 369                            | 2            | –                                             |
| 350        | 2,1              | 389                            | 2            | CR 350×400×17 HDS1 R                          |
| 370        | 2,1              | 409                            | 2            | CR 370×420×25 HDS1 R                          |
| 390        | 2,1              | 429                            | 2            | –                                             |
| 415        | 2,1              | 469                            | 2            | –                                             |

<sup>1)</sup> For additional information, refer to the section *Radial shaft seals with a low cross sectional height*, starting on page 208. For additional information about SKF seals, refer to the SKF catalogue *Industrial shaft seals*.

**Needle roller bearings with machined rings with flanges, with an inner ring**  
**d 5 – 17 mm**

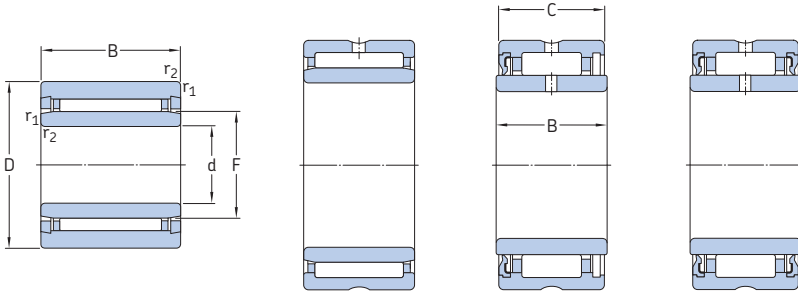

NKI (d ≤ 7 mm)

NKI(S) (d ≥ 9 mm)  
 NA 49  
 NA 69

NA 49..RS

NA 49...2RS

| Principal dimensions |    |    |    | Basic load ratings |                | Fatigue load limit | Speed ratings   |                | Mass  | Designation |
|----------------------|----|----|----|--------------------|----------------|--------------------|-----------------|----------------|-------|-------------|
| d                    | D  | B  | C  | C                  | C <sub>0</sub> | P <sub>u</sub>     | Reference speed | Limiting speed |       |             |
| mm                   |    |    |    | kN                 |                | kN                 | r/min           |                | kg    | –           |
| 5                    | 15 | 12 | –  | 3,8                | 4,25           | 0,465              | 32 000          | 36 000         | 0,012 | NKI 5/12 TN |
|                      | 15 | 16 | –  | 5,01               | 5,85           | 0,67               | 32 000          | 36 000         | 0,015 | NKI 5/16 TN |
| 6                    | 16 | 12 | –  | 4,4                | 5,2            | 0,57               | 30 000          | 34 000         | 0,014 | NKI 6/12 TN |
|                      | 16 | 16 | –  | 5,72               | 7,2            | 0,815              | 30 000          | 34 000         | 0,017 | NKI 6/16 TN |
| 7                    | 17 | 12 | –  | 4,57               | 5,7            | 0,63               | 28 000          | 32 000         | 0,014 | NKI 7/12 TN |
|                      | 17 | 16 | –  | 5,94               | 8              | 0,9                | 28 000          | 32 000         | 0,018 | NKI 7/16 TN |
| 9                    | 19 | 12 | –  | 6,71               | 8,15           | 0,965              | 26 000          | 30 000         | 0,017 | NKI 9/12    |
|                      | 19 | 16 | –  | 9,13               | 12             | 1,46               | 26 000          | 30 000         | 0,022 | NKI 9/16    |
| 10                   | 22 | 13 | –  | 8,8                | 10,4           | 1,25               | 24 000          | 28 000         | 0,023 | NA 4900     |
|                      | 22 | 14 | 13 | 7,37               | 8,15           | 0,95               | 13 000          | 12 000         | 0,025 | NA 4900 RS  |
|                      | 22 | 14 | 13 | 7,37               | 8,15           | 0,95               | –               | 12 000         | 0,025 | NA 4900.2RS |
|                      | 22 | 16 | –  | 10,2               | 12,5           | 1,53               | 24 000          | 28 000         | 0,029 | NKI 10/16   |
|                      | 22 | 20 | –  | 12,8               | 16,6           | 2,08               | 24 000          | 28 000         | 0,037 | NKI 10/20   |
| 12                   | 24 | 13 | –  | 9,9                | 12,2           | 1,46               | 22 000          | 26 000         | 0,026 | NA 4901     |
|                      | 24 | 14 | 13 | 8,09               | 9,65           | 1,14               | 22 000          | 11 000         | 0,028 | NA 4901 RS  |
|                      | 24 | 14 | 13 | 8,09               | 9,65           | 1,14               | –               | 11 000         | 0,028 | NA 4901.2RS |
|                      | 24 | 16 | –  | 11,7               | 15,3           | 1,86               | 22 000          | 26 000         | 0,033 | NKI 12/16   |
|                      | 24 | 20 | –  | 14,5               | 20             | 2,5                | 22 000          | 26 000         | 0,042 | NKI 12/20   |
|                      | 24 | 22 | –  | 16,1               | 23,2           | 2,9                | 22 000          | 26 000         | 0,046 | NA 6901     |
| 15                   | 27 | 16 | –  | 13,4               | 19             | 2,32               | 20 000          | 24 000         | 0,039 | NKI 15/16   |
|                      | 27 | 20 | –  | 16,5               | 25,5           | 3,2                | 20 000          | 24 000         | 0,049 | NKI 15/20   |
|                      | 28 | 13 | –  | 11,2               | 15,3           | 1,83               | 19 000          | 22 000         | 0,034 | NA 4902     |
|                      | 28 | 14 | 13 | 9,13               | 12             | 1,4                | 19 000          | 9 500          | 0,037 | NA 4902 RS  |
|                      | 28 | 14 | 13 | 9,13               | 12             | 1,4                | –               | 9 500          | 0,037 | NA 4902.2RS |
|                      | 28 | 23 | –  | 17,2               | 27             | 3,4                | 19 000          | 22 000         | 0,064 | NA 6902     |
|                      | 35 | 20 | –  | 24,6               | 30             | 3,9                | 16 000          | 19 000         | 0,092 | NKIS 15     |
| 17                   | 29 | 16 | –  | 13,8               | 20,4           | 2,5                | 19 000          | 22 000         | 0,042 | NKI 17/16   |
|                      | 29 | 20 | –  | 17,2               | 27             | 3,45               | 19 000          | 22 000         | 0,053 | NKI 17/20   |
|                      | 30 | 13 | –  | 11,4               | 16,3           | 1,96               | 18 000          | 20 000         | 0,037 | NA 4903     |
|                      | 30 | 14 | 13 | 9,52               | 12,9           | 1,5                | 18 000          | 9 000          | 0,040 | NA 4903 RS  |
|                      | 30 | 14 | 13 | 9,52               | 12,9           | 1,5                | –               | 9 000          | 0,040 | NA 4903.2RS |
|                      | 30 | 23 | –  | 18,7               | 30,5           | 3,9                | 18 000          | 20 000         | 0,072 | NA 6903     |
|                      | 37 | 20 | –  | 26                 | 33,5           | 4,25               | 15 000          | 17 000         | 0,098 | NKIS 17     |

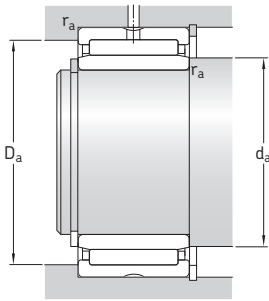

**Dimensions**

**Abutment and fillet dimensions**

| d         | F  | r <sub>1,2</sub><br>min | s <sup>1)</sup> | d <sub>a</sub><br>min | D <sub>a</sub><br>max | r <sub>a</sub><br>max |
|-----------|----|-------------------------|-----------------|-----------------------|-----------------------|-----------------------|
| mm        |    |                         | mm              |                       |                       |                       |
| <b>5</b>  | 8  | 0,3                     | 1,5             | 7                     | 13                    | 0,3                   |
|           | 8  | 0,3                     | 2               | 7                     | 13                    | 0,3                   |
| <b>6</b>  | 9  | 0,3                     | 1,5             | 8                     | 14                    | 0,3                   |
|           | 9  | 0,3                     | 2               | 8                     | 14                    | 0,3                   |
| <b>7</b>  | 10 | 0,3                     | 1,5             | 9                     | 15                    | 0,3                   |
|           | 10 | 0,3                     | 2               | 9                     | 15                    | 0,3                   |
| <b>9</b>  | 12 | 0,3                     | 1,5             | 11                    | 17                    | 0,3                   |
|           | 12 | 0,3                     | 2               | 11                    | 17                    | 0,3                   |
| <b>10</b> | 14 | 0,3                     | 0,5             | 12                    | 20                    | 0,3                   |
|           | 14 | 0,3                     | 0,5             | 12                    | 20                    | 0,3                   |
|           | 14 | 0,3                     | 0,5             | 12                    | 20                    | 0,3                   |
|           | 14 | 0,3                     | 0,5             | 12                    | 20                    | 0,3                   |
|           | 14 | 0,3                     | 0,5             | 12                    | 20                    | 0,3                   |
| <b>12</b> | 16 | 0,3                     | 0,5             | 14                    | 22                    | 0,3                   |
|           | 16 | 0,3                     | 0,5             | 14                    | 22                    | 0,3                   |
|           | 16 | 0,3                     | 0,5             | 14                    | 22                    | 0,3                   |
|           | 16 | 0,3                     | 0,5             | 14                    | 22                    | 0,3                   |
|           | 16 | 0,3                     | 0,5             | 14                    | 22                    | 0,3                   |
|           | 16 | 0,3                     | 1               | 14                    | 22                    | 0,3                   |
| <b>15</b> | 19 | 0,3                     | 0,5             | 17                    | 25                    | 0,3                   |
|           | 19 | 0,3                     | 0,5             | 17                    | 25                    | 0,3                   |
|           | 20 | 0,3                     | 0,5             | 17                    | 26                    | 0,3                   |
|           | 20 | 0,3                     | 0,5             | 17                    | 26                    | 0,3                   |
|           | 20 | 0,3                     | 0,5             | 17                    | 26                    | 0,3                   |
|           | 20 | 0,3                     | 1               | 17                    | 26                    | 0,3                   |
|           | 22 | 0,6                     | 0,5             | 19                    | 31                    | 0,6                   |
| <b>17</b> | 21 | 0,3                     | 0,5             | 19                    | 27                    | 0,3                   |
|           | 21 | 0,3                     | 0,5             | 19                    | 27                    | 0,3                   |
|           | 22 | 0,3                     | 0,5             | 19                    | 28                    | 0,3                   |
|           | 22 | 0,3                     | 0,5             | 19                    | 28                    | 0,3                   |
|           | 22 | 0,3                     | 0,5             | 19                    | 28                    | 0,3                   |
|           | 22 | 0,3                     | 0,5             | 19                    | 28                    | 0,3                   |
|           | 24 | 0,6                     | 0,5             | 21                    | 33                    | 0,6                   |

<sup>1)</sup> Permissible axial displacement from normal position of one bearing ring relative to the other

## Needle roller bearings with machined rings with flanges, with an inner ring d 20 – 32 mm

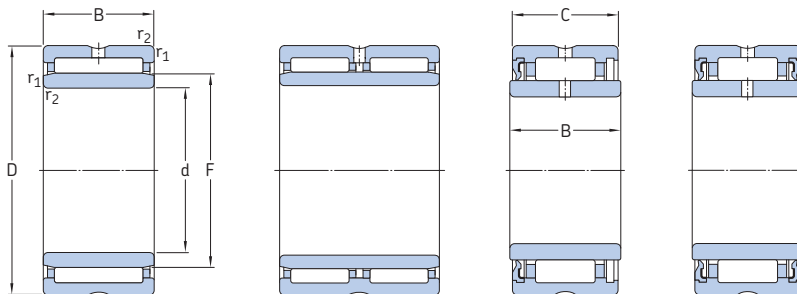

NKI(S)  
NA 49  
NA 69 (D ≤ 47 mm)

NA 69 (D ≥ 52 mm)

NA 49..RS

NA 49...2RS

| Principal dimensions |    |    |    |   | Basic load ratings |                | Fatigue load limit | Speed ratings   |                | Mass   | Designation  |
|----------------------|----|----|----|---|--------------------|----------------|--------------------|-----------------|----------------|--------|--------------|
|                      | d  | D  | B  | C | C                  | C <sub>0</sub> |                    | Reference speed | Limiting speed |        |              |
| mm                   |    |    |    |   | kN                 | kN             |                    | r/min           | kg             | –      |              |
| 20                   | 32 | 16 | –  | – | 15,4               | 24,5           | 3                  | 16 000          | 19 000         | 0,049  | NKI 20/16    |
|                      | 32 | 20 | –  | – | 19                 | 32,5           | 4,05               | 16 000          | 19 000         | 0,061  | NKI 20/20    |
|                      | 37 | 17 | –  | – | 21,6               | 28             | 3,55               | 15 000          | 17 000         | 0,075  | NA 4904      |
|                      | 37 | 18 | 17 | – | 19,4               | 22,4           | 2,75               | 15 000          | 7 500          | 0,080  | NA 4904 RS   |
|                      | 37 | 18 | 17 | – | 19,4               | 22,4           | 2,75               | –               | 7 500          | 0,080  | NA 4904.2RS  |
|                      | 37 | 30 | –  | – | 35,2               | 53             | 6,95               | 15 000          | 17 000         | 0,14   | NA 6904      |
|                      | 42 | 20 | –  | – | 28,6               | 39             | 5                  | 13 000          | 15 000         | 0,13   | NKI 20       |
|                      | 22 | 34 | 16 | – | –                  | 15,7           | 26                 | 3,2             | 15 000         | 17 000 | 0,052        |
| 34                   |    | 20 | –  | – | 19,4               | 34,5           | 4,3                | 15 000          | 17 000         | 0,065  | NKI 22/20    |
| 39                   |    | 17 | –  | – | 23,3               | 32             | 4,05               | 14 000          | 15 000         | 0,080  | NA 49/22     |
| 39                   |    | 30 | –  | – | 36,9               | 57             | 7,5                | 14 000          | 15 000         | 0,15   | NA 69/22     |
| 25                   |    | 38 | 20 | – | –                  | 24,6           | 42,5               | 5,2             | 14 000         | 15 000 | 0,076        |
|                      | 38 | 30 | –  | – | 31,9               | 60             | 7,8                | 14 000          | 15 000         | 0,12   | NKI 25/30    |
|                      | 42 | 17 | –  | – | 24,2               | 34,5           | 4,3                | 13 000          | 15 000         | 0,088  | NA 4905      |
|                      | 42 | 18 | 17 | – | 21,6               | 27,5           | 3,35               | 13 000          | 6 300          | 0,090  | NA 4905 RS   |
|                      | 42 | 18 | 17 | – | 21,6               | 27,5           | 3,35               | –               | 6 300          | 0,090  | NA 4905.2RS  |
|                      | 42 | 30 | –  | – | 38                 | 62             | 8,15               | 13 000          | 15 000         | 0,16   | NA 6905      |
|                      | 47 | 22 | –  | – | 34,1               | 46,5           | 6                  | 12 000          | 13 000         | 0,16   | NKI 25       |
|                      | 28 | 42 | 20 | – | –                  | 26,4           | 48                 | 6               | 12 000         | 14 000 | 0,093        |
| 42                   |    | 30 | –  | – | 34,1               | 65,5           | 8,65               | 12 000          | 14 000         | 0,15   | NKI 28/30    |
| 45                   |    | 17 | –  | – | 25,1               | 36,5           | 4,55               | 12 000          | 14 000         | 0,098  | NA 49/28     |
| 45                   |    | 30 | –  | – | 39,6               | 65,5           | 8,65               | 12 000          | 14 000         | 0,18   | NA 69/28     |
| 30                   | 45 | 20 | –  | – | 27,5               | 52             | 6,55               | 11 000          | 13 000         | 0,11   | NKI 30/20 TN |
|                      | 45 | 30 | –  | – | 40,2               | 85             | 10,6               | 11 000          | 13 000         | 0,17   | NKI 30/30 TN |
|                      | 47 | 17 | –  | – | 25,5               | 39             | 4,9                | 11 000          | 13 000         | 0,10   | NA 4906      |
|                      | 47 | 18 | 17 | – | 23,3               | 32             | 3,9                | 11 000          | 5 600          | 0,10   | NA 4906 RS   |
|                      | 47 | 18 | 17 | – | 23,3               | 32             | 3,9                | –               | 5 600          | 0,10   | NA 4906.2RS  |
|                      | 47 | 30 | –  | – | 42,9               | 75             | 9,8                | 11 000          | 13 000         | 0,19   | NA 6906      |
|                      | 52 | 22 | –  | – | 36                 | 54             | 6,95               | 10 000          | 12 000         | 0,18   | NKI 30       |
|                      | 32 | 47 | 20 | – | –                  | 25,1           | 46,5               | 5,85            | 11 000         | 12 000 | 0,12         |
| 47                   |    | 30 | –  | – | 36,9               | 76,5           | 10                 | 11 000          | 12 000         | 0,18   | NKI 32/30    |
| 52                   |    | 20 | –  | – | 30,8               | 51             | 6,55               | 10 000          | 11 000         | 0,16   | NA 49/32     |
| 52                   |    | 36 | –  | – | 47,3               | 90             | 11,2               | 10 000          | 11 000         | 0,29   | NA 69/32     |

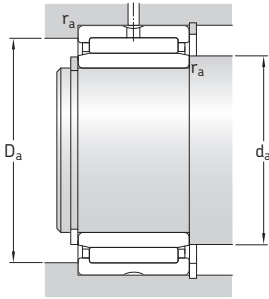

**Dimensions**

**Abutment and fillet dimensions**

| d         | F  | r <sub>1,2</sub><br>min | s <sup>1)</sup> | d <sub>a</sub><br>min | D <sub>a</sub><br>max | r <sub>a</sub><br>max |
|-----------|----|-------------------------|-----------------|-----------------------|-----------------------|-----------------------|
| mm        |    |                         |                 | mm                    |                       |                       |
| <b>20</b> | 24 | 0,3                     | 0,5             | 22                    | 30                    | 0,3                   |
|           | 24 | 0,3                     | 0,5             | 22                    | 30                    | 0,3                   |
|           | 25 | 0,3                     | 0,8             | 22                    | 35                    | 0,3                   |
|           | 25 | 0,3                     | 0,5             | 22                    | 35                    | 0,3                   |
|           | 25 | 0,3                     | 0,5             | 22                    | 35                    | 0,3                   |
|           | 25 | 0,3                     | 1               | 22                    | 35                    | 0,3                   |
|           | 28 | 0,6                     | 0,5             | 24                    | 38                    | 0,6                   |
| <b>22</b> | 26 | 0,3                     | 0,5             | 24                    | 32                    | 0,3                   |
|           | 26 | 0,3                     | 0,5             | 24                    | 32                    | 0,3                   |
|           | 28 | 0,3                     | 0,8             | 24                    | 37                    | 0,3                   |
|           | 28 | 0,3                     | 0,5             | 24                    | 37                    | 0,3                   |
| <b>25</b> | 29 | 0,3                     | 1               | 27                    | 36                    | 0,3                   |
|           | 29 | 0,3                     | 1,5             | 27                    | 36                    | 0,3                   |
|           | 30 | 0,3                     | 0,8             | 27                    | 40                    | 0,3                   |
|           | 30 | 0,3                     | 0,5             | 27                    | 40                    | 0,3                   |
|           | 30 | 0,3                     | 0,5             | 27                    | 40                    | 0,3                   |
|           | 30 | 0,3                     | 1               | 27                    | 40                    | 0,3                   |
|           | 32 | 0,6                     | 1               | 29                    | 43                    | 0,6                   |
| <b>28</b> | 32 | 0,3                     | 1               | 30                    | 40                    | 0,3                   |
|           | 32 | 0,3                     | 1,5             | 30                    | 40                    | 0,3                   |
|           | 32 | 0,3                     | 0,8             | 30                    | 43                    | 0,3                   |
|           | 32 | 0,3                     | 1               | 30                    | 43                    | 0,3                   |
| <b>30</b> | 35 | 0,3                     | 0,5             | 32                    | 43                    | 0,3                   |
|           | 35 | 0,3                     | 1               | 32                    | 43                    | 0,3                   |
|           | 35 | 0,3                     | 0,8             | 32                    | 45                    | 0,3                   |
|           | 35 | 0,3                     | 0,5             | 32                    | 45                    | 0,3                   |
|           | 35 | 0,3                     | 0,5             | 32                    | 45                    | 0,3                   |
|           | 35 | 0,3                     | 1               | 32                    | 45                    | 0,3                   |
|           | 37 | 0,6                     | 1               | 34                    | 48                    | 0,6                   |
| <b>32</b> | 37 | 0,3                     | 0,5             | 34                    | 45                    | 0,3                   |
|           | 37 | 0,3                     | 1               | 34                    | 45                    | 0,3                   |
|           | 40 | 0,6                     | 0,8             | 36                    | 48                    | 0,6                   |
|           | 40 | 0,6                     | 0,5             | 36                    | 48                    | 0,6                   |

<sup>1)</sup> Permissible axial displacement from normal position of one bearing ring in relation to the other

**Needle roller bearings with machined rings with flanges, with an inner ring**  
**d 35 – 50 mm**

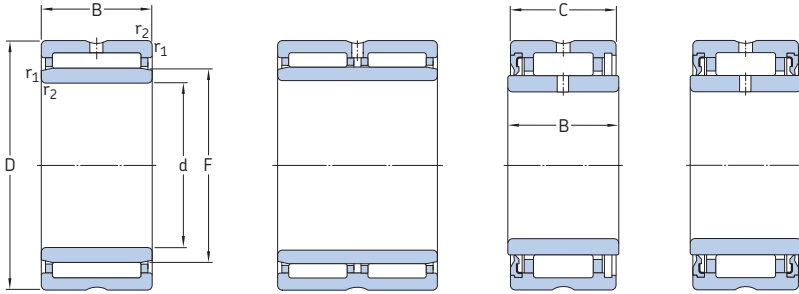

NKI(S)  
NA 49

NA 69

NA 49..RS

NA 49...2RS

| Principal dimensions |    |    |    | Basic load ratings |                | Fatigue load limit | Speed ratings   |                | Mass | Designation  |
|----------------------|----|----|----|--------------------|----------------|--------------------|-----------------|----------------|------|--------------|
| d                    | D  | B  | C  | C                  | C <sub>0</sub> | P <sub>U</sub>     | Reference speed | Limiting speed |      |              |
| mm                   |    |    |    | kN                 |                | kN                 | r/min           |                | kg   | –            |
| 35                   | 50 | 20 | –  | 30,3               | 61             | 7,5                | 10 000          | 11 000         | 0,13 | NKI 35/20 TN |
|                      | 50 | 30 | –  | 38                 | 83             | 10,8               | 10 000          | 11 000         | 0,19 | NKI 35/30    |
|                      | 55 | 20 | –  | 31,9               | 54             | 6,95               | 9 500           | 11 000         | 0,17 | NA 4907      |
|                      | 55 | 21 | 20 | 27                 | 43             | 5,4                | 9 500           | 5 400          | 0,18 | NA 4907 RS   |
|                      | 55 | 21 | 20 | 27                 | 43             | 5,4                | –               | 5 400          | 0,18 | NA 4907.2RS  |
|                      | 55 | 36 | –  | 48,4               | 93             | 11,8               | 9 500           | 11 000         | 0,31 | NA 6907      |
|                      | 58 | 22 | –  | 39,1               | 61             | 7,8                | 9 000           | 10 000         | 0,22 | NKIS 35      |
| 38                   | 53 | 20 | –  | 27,5               | 55             | 6,95               | 9 500           | 11 000         | 0,14 | NKI 38/20    |
|                      | 53 | 30 | –  | 40,2               | 90             | 11,6               | 9 500           | 11 000         | 0,21 | NKI 38/30    |
| 40                   | 55 | 20 | –  | 31,4               | 67             | 8,3                | 9 000           | 10 000         | 0,14 | NKI 40/20 TN |
|                      | 55 | 30 | –  | 45,7               | 108            | 13,4               | 9 000           | 10 000         | 0,22 | NKI 40/30 TN |
|                      | 62 | 22 | –  | 42,9               | 71             | 9,15               | 8 000           | 9 500          | 0,23 | NA 4908      |
|                      | 62 | 23 | 22 | 36,9               | 58,5           | 7,35               | 8 000           | 4 000          | 0,25 | NA 4908 RS   |
|                      | 62 | 23 | 22 | 36,9               | 58,5           | 7,35               | –               | 4 000          | 0,25 | NA 4908.2RS  |
|                      | 62 | 40 | –  | 67,1               | 125            | 16                 | 8 000           | 9 500          | 0,43 | NA 6908      |
|                      | 65 | 22 | –  | 42,9               | 72             | 9,15               | 8 000           | 9 000          | 0,28 | NKIS 40      |
| 42                   | 57 | 20 | –  | 29,2               | 61             | 7,65               | 8 500           | 10 000         | 0,15 | NKI 42/20    |
|                      | 57 | 30 | –  | 41,8               | 98             | 12,9               | 8 500           | 10 000         | 0,22 | NKI 42/30    |
| 45                   | 62 | 25 | –  | 42,9               | 93             | 11,2               | 8 000           | 9 000          | 0,22 | NKI 45/25 TN |
|                      | 62 | 35 | –  | 58,3               | 137            | 17                 | 8 000           | 9 000          | 0,31 | NKI 45/35 TN |
|                      | 68 | 22 | –  | 45,7               | 78             | 10                 | 7 500           | 8 500          | 0,27 | NA 4909      |
|                      | 68 | 23 | 22 | 39,1               | 64             | 8                  | 7 500           | 3 800          | 0,29 | NA 4909 RS   |
|                      | 68 | 23 | 22 | 39,1               | 64             | 8                  | –               | 3 800          | 0,29 | NA 4909.2RS  |
|                      | 68 | 40 | –  | 70,4               | 137            | 17,3               | 7 500           | 8 500          | 0,50 | NA 6909      |
|                      | 72 | 22 | –  | 44,6               | 78             | 10                 | 7 000           | 8 000          | 0,34 | NKIS 45      |
| 50                   | 68 | 25 | –  | 40,2               | 88             | 11,2               | 7 500           | 8 500          | 0,27 | NKI 50/25    |
|                      | 68 | 35 | –  | 52,3               | 122            | 16                 | 7 500           | 8 500          | 0,38 | NKI 50/35    |
|                      | 72 | 22 | –  | 47,3               | 85             | 11                 | 7 000           | 8 000          | 0,27 | NA 4910      |
|                      | 72 | 23 | 22 | 40,2               | 69,5           | 8,8                | 7 000           | 3 400          | 0,30 | NA 4910 RS   |
|                      | 72 | 23 | 22 | 40,2               | 69,5           | 8,8                | –               | 3 400          | 0,30 | NA 4910.2RS  |
|                      | 72 | 40 | –  | 73,7               | 150            | 19                 | 7 000           | 8 000          | 0,52 | NA 6910      |
|                      | 80 | 28 | –  | 62,7               | 104            | 13,7               | 6 300           | 7 500          | 0,52 | NKIS 50      |



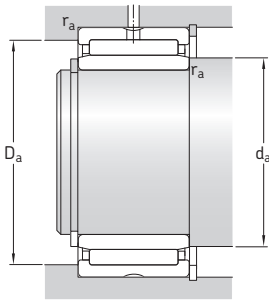

### Dimensions

### Abutment and fillet dimensions

| d  | F  | $r_{1,2}$<br>min | $s^1)$ | $d_a$<br>min | $D_a$<br>max | $r_a$<br>max |
|----|----|------------------|--------|--------------|--------------|--------------|
| mm |    |                  |        | mm           |              |              |
| 35 | 40 | 0,3              | 0,5    | 37           | 48           | 0,3          |
|    | 40 | 0,3              | 1      | 37           | 48           | 0,3          |
|    | 42 | 0,6              | 0,8    | 39           | 51           | 0,6          |
|    | 42 | 0,6              | 0,5    | 39           | 51           | 0,6          |
|    | 42 | 0,6              | 0,5    | 39           | 51           | 0,6          |
|    | 42 | 0,6              | 0,5    | 39           | 51           | 0,6          |
|    | 43 | 0,6              | 0,5    | 39           | 54           | 0,6          |
| 38 | 43 | 0,3              | 0,5    | 40           | 51           | 0,3          |
|    | 43 | 0,3              | 1      | 40           | 51           | 0,3          |
| 40 | 45 | 0,3              | 0,5    | 42           | 53           | 0,3          |
|    | 45 | 0,3              | 1      | 42           | 53           | 0,3          |
|    | 48 | 0,6              | 1      | 44           | 58           | 0,6          |
|    | 48 | 0,6              | 0,5    | 44           | 58           | 0,6          |
|    | 48 | 0,6              | 0,5    | 44           | 58           | 0,6          |
|    | 48 | 0,6              | 0,5    | 44           | 58           | 0,6          |
|    | 50 | 1                | 0,5    | 45           | 60           | 1            |
| 42 | 47 | 0,3              | 0,5    | 44           | 55           | 0,3          |
|    | 47 | 0,3              | 1      | 44           | 55           | 0,3          |
| 45 | 50 | 0,6              | 1,5    | 49           | 58           | 0,6          |
|    | 50 | 0,6              | 2      | 49           | 58           | 0,6          |
|    | 52 | 0,6              | 1      | 49           | 64           | 0,6          |
|    | 52 | 0,6              | 0,5    | 49           | 64           | 0,6          |
|    | 52 | 0,6              | 0,5    | 49           | 64           | 0,6          |
|    | 52 | 0,6              | 0,5    | 49           | 64           | 0,6          |
|    | 55 | 1                | 0,5    | 50           | 67           | 1            |
| 50 | 55 | 0,6              | 1,5    | 54           | 64           | 0,6          |
|    | 55 | 0,6              | 2      | 54           | 64           | 0,6          |
|    | 58 | 0,6              | 1      | 54           | 68           | 0,6          |
|    | 58 | 0,6              | 0,5    | 54           | 68           | 0,6          |
|    | 58 | 0,6              | 0,5    | 54           | 68           | 0,6          |
|    | 58 | 0,6              | 0,5    | 54           | 68           | 0,6          |
|    | 58 | 0,6              | 0,5    | 54           | 68           | 0,6          |
|    | 60 | 1,1              | 2      | 56,5         | 73,5         | 1            |

<sup>1)</sup> Permissible axial displacement from normal position of one bearing ring in relation to the other

**Needle roller bearings with machined rings with flanges, with an inner ring**  
**d 55 – 85 mm**

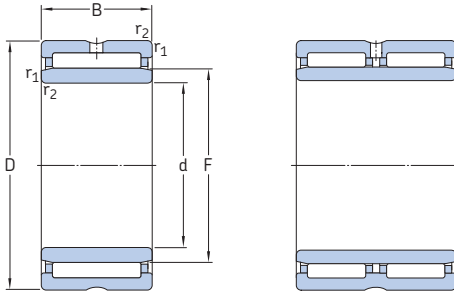

NKI(S)  
NA 49

NA 69

| Principal dimensions |     |    | Basic load ratings |                | Fatigue load limit | Speed ratings   |                | Mass | Designation         |
|----------------------|-----|----|--------------------|----------------|--------------------|-----------------|----------------|------|---------------------|
| d                    | D   | B  | dynamic            | static         |                    | Reference speed | Limiting speed |      |                     |
| mm                   |     |    | C                  | C <sub>0</sub> | P <sub>u</sub>     | r/min           |                | kg   | –                   |
| <b>55</b>            | 72  | 25 | 46,8               | 110            | 13,4               | 6 700           | 7 500          | 0,26 | <b>NKI 55/25 TN</b> |
|                      | 72  | 35 | 55                 | 134            | 17,6               | 6 700           | 7 500          | 0,38 | <b>NKI 55/35</b>    |
|                      | 80  | 25 | 57,2               | 106            | 13,7               | 6 300           | 7 000          | 0,39 | <b>NA 4911</b>      |
|                      | 80  | 45 | 89,7               | 190            | 24                 | 6 300           | 7 000          | 0,78 | <b>NA 6911</b>      |
|                      | 85  | 28 | 66                 | 114            | 15                 | 6 000           | 6 700          | 0,56 | <b>NKIS 55</b>      |
| <b>60</b>            | 82  | 25 | 44                 | 95             | 12                 | 6 000           | 6 700          | 0,39 | <b>NKI 60/25</b>    |
|                      | 82  | 35 | 60,5               | 146            | 19                 | 6 000           | 6 700          | 0,55 | <b>NKI 60/35</b>    |
|                      | 85  | 25 | 60,5               | 114            | 14,6               | 6 000           | 6 700          | 0,43 | <b>NA 4912</b>      |
|                      | 85  | 45 | 93,5               | 204            | 26                 | 6 000           | 6 700          | 0,81 | <b>NA 6912</b>      |
|                      | 90  | 28 | 68,2               | 120            | 15,6               | 5 600           | 6 300          | 0,56 | <b>NKIS 60</b>      |
| <b>65</b>            | 90  | 25 | 61,6               | 120            | 15,3               | 5 600           | 6 300          | 0,46 | <b>NA 4913</b>      |
|                      | 90  | 25 | 52,8               | 106            | 13,7               | 5 600           | 6 300          | 0,47 | <b>NKI 65/25</b>    |
|                      | 90  | 35 | 73,7               | 163            | 21,6               | 5 600           | 6 300          | 0,66 | <b>NKI 65/35</b>    |
|                      | 90  | 45 | 95,2               | 212            | 27                 | 5 600           | 6 300          | 0,83 | <b>NA 6913</b>      |
|                      | 95  | 28 | 70,4               | 132            | 17                 | 5 300           | 6 000          | 0,64 | <b>NKIS 65</b>      |
| <b>70</b>            | 95  | 25 | 56,1               | 127            | 16                 | 5 000           | 5 600          | 0,52 | <b>NKI 70/25</b>    |
|                      | 95  | 35 | 76,5               | 190            | 25                 | 5 000           | 5 600          | 0,74 | <b>NKI 70/35</b>    |
|                      | 100 | 30 | 84,2               | 163            | 21,6               | 5 000           | 5 600          | 0,73 | <b>NA 4914</b>      |
|                      | 100 | 54 | 128                | 285            | 37,5               | 5 000           | 5 600          | 1,35 | <b>NA 6914</b>      |
| <b>75</b>            | 105 | 25 | 69,3               | 132            | 17                 | 4 800           | 5 300          | 0,64 | <b>NKI 75/25</b>    |
|                      | 105 | 30 | 84,2               | 170            | 22,4               | 4 800           | 5 300          | 0,78 | <b>NA 4915</b>      |
|                      | 105 | 35 | 96,8               | 200            | 27                 | 4 800           | 5 300          | 0,91 | <b>NKI 75/35</b>    |
|                      | 105 | 54 | 130                | 290            | 38                 | 4 800           | 5 300          | 1,45 | <b>NA 6915</b>      |
| <b>80</b>            | 110 | 25 | 72,1               | 140            | 18,3               | 4 500           | 5 000          | 0,68 | <b>NKI 80/25</b>    |
|                      | 110 | 30 | 88                 | 183            | 24                 | 4 500           | 5 000          | 0,88 | <b>NA 4916</b>      |
|                      | 110 | 35 | 101                | 216            | 29                 | 4 500           | 5 000          | 0,96 | <b>NKI 80/35</b>    |
|                      | 110 | 54 | 134                | 315            | 41,5               | 4 500           | 5 000          | 1,50 | <b>NA 6916</b>      |
| <b>85</b>            | 115 | 26 | 73,7               | 146            | 19                 | 4 300           | 4 800          | 0,74 | <b>NKI 85/26</b>    |
|                      | 115 | 36 | 105                | 232            | 30,5               | 4 300           | 4 800          | 1,05 | <b>NKI 85/36</b>    |
|                      | 120 | 35 | 108                | 250            | 32                 | 4 000           | 4 500          | 1,25 | <b>NA 4917</b>      |
|                      | 120 | 63 | 165                | 425            | 54                 | 4 000           | 4 500          | 2,20 | <b>NA 6917</b>      |

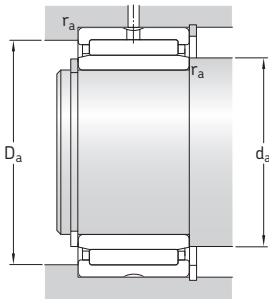

### Dimensions

### Abutment and fillet dimensions

| d         | F   | $r_{1,2}$<br>min | $s^1)$ | $d_a$<br>min | $D_a$<br>max | $r_a$<br>max |
|-----------|-----|------------------|--------|--------------|--------------|--------------|
| mm        |     |                  |        | mm           |              |              |
| <b>55</b> | 60  | 0,6              | 1,5    | 59           | 68           | 0,6          |
|           | 60  | 0,6              | 2      | 59           | 68           | 0,6          |
|           | 63  | 1                | 1,5    | 60           | 75           | 1            |
|           | 63  | 1                | 1,5    | 60           | 75           | 1            |
|           | 65  | 1,1              | 2      | 61,5         | 78,5         | 1            |
| <b>60</b> | 68  | 0,6              | 1      | 64           | 78           | 0,6          |
|           | 68  | 0,6              | 1      | 64           | 78           | 0,6          |
|           | 68  | 1                | 1,5    | 65           | 80           | 1            |
|           | 68  | 1                | 1,5    | 65           | 80           | 1            |
|           | 70  | 1,1              | 2      | 66,5         | 83,5         | 1            |
| <b>65</b> | 72  | 1                | 1,5    | 70           | 85           | 1            |
|           | 73  | 1                | 1      | 70           | 85           | 1            |
|           | 73  | 1                | 1      | 70           | 85           | 1            |
|           | 72  | 1                | 1,5    | 70           | 85           | 1            |
|           | 75  | 1,1              | 2      | 71,5         | 88,5         | 1            |
| <b>70</b> | 80  | 1                | 0,8    | 75           | 90           | 1            |
|           | 80  | 1                | 0,8    | 75           | 90           | 1            |
|           | 80  | 1                | 1,5    | 75           | 95           | 1            |
|           | 80  | 1                | 1      | 75           | 95           | 1            |
| <b>75</b> | 85  | 1                | 1      | 80           | 100          | 1            |
|           | 85  | 1                | 1,5    | 80           | 100          | 1            |
|           | 85  | 1                | 1      | 80           | 100          | 1            |
|           | 85  | 1                | 1      | 80           | 100          | 1            |
| <b>80</b> | 90  | 1                | 1      | 85           | 105          | 1            |
|           | 90  | 1                | 1,5    | 85           | 105          | 1            |
|           | 90  | 1                | 1      | 85           | 105          | 1            |
|           | 90  | 1                | 1      | 85           | 105          | 1            |
| <b>85</b> | 95  | 1                | 1,5    | 90           | 110          | 1            |
|           | 95  | 1                | 1,5    | 90           | 110          | 1            |
|           | 100 | 1,1              | 1      | 91,5         | 113,5        | 1            |
|           | 100 | 1,1              | 1      | 91,5         | 113,5        | 1            |

<sup>1)</sup> Permissible axial displacement from normal position of one bearing ring in relation to the other

**Needle roller bearings with machined rings with flanges, with an inner ring**  
**d 90 – 220 mm**

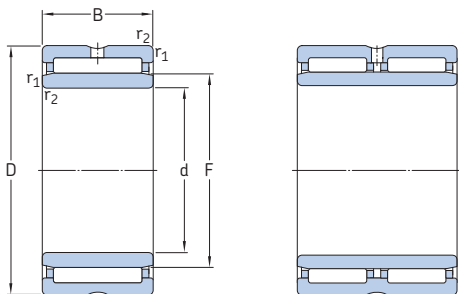

NKI  
 NA 48  
 NA 49

NA 69

| Principal dimensions |     |    | Basic load ratings |                | Fatigue load limit | Speed ratings   |                | Mass | Designation       |
|----------------------|-----|----|--------------------|----------------|--------------------|-----------------|----------------|------|-------------------|
| d                    | D   | B  | dynamic            | static         |                    | Reference speed | Limiting speed |      |                   |
| mm                   |     |    | C                  | C <sub>0</sub> | P <sub>u</sub>     | r/min           |                | kg   | –                 |
| <b>90</b>            | 120 | 26 | 76,5               | 156            | 19,6               | 4 000           | 4 500          | 0,78 | <b>NKI 90/26</b>  |
|                      | 120 | 36 | 108                | 250            | 32                 | 4 000           | 4 500          | 1,10 | <b>NKI 90/36</b>  |
|                      | 125 | 35 | 112                | 265            | 33,5               | 3 800           | 4 300          | 1,30 | <b>NA 4918</b>    |
|                      | 125 | 63 | 172                | 450            | 57                 | 3 800           | 4 300          | 2,30 | <b>NA 6918</b>    |
| <b>95</b>            | 125 | 26 | 78,1               | 166            | 20,8               | 3 800           | 4 300          | 0,82 | <b>NKI 95/26</b>  |
|                      | 125 | 36 | 112                | 265            | 33,5               | 3 800           | 4 300          | 1,15 | <b>NKI 95/36</b>  |
|                      | 130 | 35 | 114                | 270            | 34                 | 3 600           | 4 000          | 1,35 | <b>NA 4919</b>    |
|                      | 130 | 63 | 172                | 465            | 57                 | 3 600           | 4 000          | 2,50 | <b>NA 6919</b>    |
| <b>100</b>           | 130 | 30 | 96,8               | 220            | 27,5               | 3 600           | 4 000          | 0,99 | <b>NKI 100/30</b> |
|                      | 130 | 40 | 123                | 305            | 38                 | 3 600           | 4 000          | 1,35 | <b>NKI 100/40</b> |
|                      | 140 | 40 | 125                | 280            | 34,5               | 3 400           | 4 000          | 1,90 | <b>NA 4920</b>    |
| <b>110</b>           | 140 | 30 | 93,5               | 232            | 27,5               | 3 400           | 3 800          | 1,10 | <b>NA 4822</b>    |
|                      | 150 | 40 | 130                | 300            | 36,5               | 3 200           | 3 600          | 2,05 | <b>NA 4922</b>    |
| <b>120</b>           | 150 | 30 | 99                 | 255            | 30                 | 3 200           | 3 600          | 1,15 | <b>NA 4824</b>    |
|                      | 165 | 45 | 176                | 405            | 47,5               | 3 000           | 3 400          | 2,85 | <b>NA 4924</b>    |
| <b>130</b>           | 165 | 35 | 119                | 325            | 37,5               | 2 800           | 3 200          | 1,80 | <b>NA 4826</b>    |
|                      | 180 | 50 | 198                | 480            | 55                 | 2 600           | 3 000          | 3,90 | <b>NA 4926</b>    |
| <b>140</b>           | 175 | 35 | 121                | 345            | 38                 | 2 600           | 3 000          | 1,90 | <b>NA 4828</b>    |
|                      | 190 | 50 | 205                | 510            | 58,5               | 2 400           | 2 800          | 4,15 | <b>NA 4928</b>    |
| <b>150</b>           | 190 | 40 | 147                | 415            | 46,5               | 2 400           | 2 800          | 2,70 | <b>NA 4830</b>    |
| <b>160</b>           | 200 | 40 | 157                | 450            | 50                 | 2 200           | 2 600          | 2,90 | <b>NA 4832</b>    |
| <b>170</b>           | 215 | 45 | 179                | 520            | 57                 | 2 200           | 2 400          | 3,95 | <b>NA 4834</b>    |
| <b>180</b>           | 225 | 45 | 190                | 570            | 60                 | 2 000           | 2 400          | 4,20 | <b>NA 4836</b>    |
| <b>190</b>           | 240 | 50 | 220                | 710            | 73,5               | 1 900           | 2 200          | 5,60 | <b>NA 4838</b>    |
| <b>200</b>           | 250 | 50 | 224                | 735            | 75                 | 1 800           | 2 000          | 5,85 | <b>NA 4840</b>    |
| <b>220</b>           | 270 | 50 | 238                | 815            | 81,5               | 1 700           | 1 900          | 6,40 | <b>NA 4844</b>    |

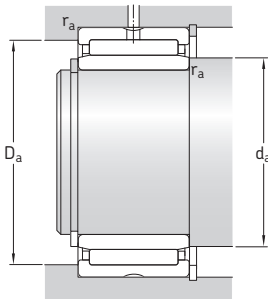

### Dimensions

### Abutment and fillet dimensions

| d          | F   | $r_{1,2}$<br>min | $s^1)$ | $d_a$<br>min | $D_a$<br>max | $r_a$<br>max |
|------------|-----|------------------|--------|--------------|--------------|--------------|
| mm         |     |                  |        | mm           |              |              |
| <b>90</b>  | 100 | 1                | 1,5    | 95           | 115          | 1            |
|            | 100 | 1                | 1,5    | 95           | 115          | 1            |
|            | 105 | 1,1              | 1      | 96,5         | 118,5        | 1            |
|            | 105 | 1,1              | 1      | 96,5         | 118,5        | 1            |
|            | 105 | 1,1              | 1      | 96,5         | 118,5        | 1            |
| <b>95</b>  | 105 | 1                | 1,5    | 100          | 120          | 1            |
|            | 105 | 1                | 1,5    | 100          | 120          | 1            |
|            | 110 | 1,1              | 1      | 101,5        | 123,5        | 1            |
|            | 110 | 1,1              | 1      | 101,5        | 123,5        | 1            |
|            | 110 | 1,1              | 1      | 101,5        | 123,5        | 1            |
| <b>100</b> | 110 | 1,1              | 1,5    | 106,5        | 123,5        | 1            |
|            | 110 | 1,1              | 2      | 106,5        | 123,5        | 1            |
|            | 115 | 1,1              | 2      | 106,5        | 133,5        | 1            |
| <b>110</b> | 120 | 1                | 0,8    | 115          | 135          | 1            |
|            | 125 | 1,1              | 2      | 116,5        | 143,5        | 1            |
| <b>120</b> | 130 | 1                | 0,8    | 125          | 145          | 1            |
|            | 135 | 1,1              | 2      | 126,5        | 158,5        | 1            |
| <b>130</b> | 145 | 1,1              | 1      | 136,5        | 158,5        | 1            |
|            | 150 | 1,5              | 1,5    | 138          | 172          | 1,5          |
| <b>140</b> | 155 | 1,1              | 1      | 146,5        | 168,5        | 1            |
|            | 160 | 1,5              | 1,5    | 148          | 182          | 1,5          |
| <b>150</b> | 165 | 1,1              | 1,5    | 156,5        | 183,5        | 1            |
| <b>160</b> | 175 | 1,1              | 1,5    | 166,5        | 193,5        | 1            |
| <b>170</b> | 185 | 1,1              | 1,5    | 176,5        | 208,5        | 1            |
| <b>180</b> | 195 | 1,1              | 1,5    | 186,5        | 218,5        | 1            |
| <b>190</b> | 210 | 1,5              | 1,5    | 198          | 232          | 1,5          |
| <b>200</b> | 220 | 1,5              | 1,5    | 208          | 242          | 1,5          |
| <b>220</b> | 240 | 1,5              | 1,5    | 228          | 262          | 1,5          |

<sup>1)</sup> Permissible axial displacement from normal position of one bearing ring in relation to the other

**Needle roller bearings with machined rings with flanges, with an inner ring**  
**d 240 – 380 mm**

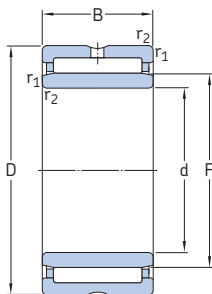

NA 48

| Principal dimensions |     |     | Basic load ratings |        | Fatigue load limit | Speed ratings   |                | Mass | Designation    |
|----------------------|-----|-----|--------------------|--------|--------------------|-----------------|----------------|------|----------------|
| d                    | D   | B   | dynamic            | static |                    | Reference speed | Limiting speed |      |                |
| mm                   |     |     | kN                 |        | kN                 | r/min           |                | kg   | –              |
| <b>240</b>           | 300 | 60  | 347                | 1 120  | 108                | 1 500           | 1 700          | 10,0 | <b>NA 4848</b> |
| <b>260</b>           | 320 | 60  | 358                | 1 200  | 114                | 1 400           | 1 500          | 10,5 | <b>NA 4852</b> |
| <b>280</b>           | 350 | 69  | 429                | 1 320  | 127                | 1 300           | 1 400          | 15,5 | <b>NA 4856</b> |
| <b>300</b>           | 380 | 80  | 594                | 1 800  | 170                | 1 100           | 1 300          | 22,0 | <b>NA 4860</b> |
| <b>320</b>           | 400 | 80  | 605                | 1 900  | 176                | 1 100           | 1 200          | 23,0 | <b>NA 4864</b> |
| <b>340</b>           | 420 | 80  | 616                | 1 960  | 180                | 1 000           | 1 200          | 24,0 | <b>NA 4868</b> |
| <b>360</b>           | 440 | 80  | 627                | 2 040  | 186                | 950             | 1 100          | 25,5 | <b>NA 4872</b> |
| <b>380</b>           | 480 | 100 | 968                | 3 000  | 265                | 900             | 1 000          | 42,5 | <b>NA 4876</b> |

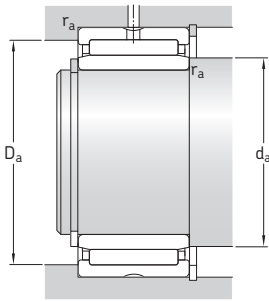

#### Dimensions

#### Abutment and fillet dimensions

| d   | F   | $r_{1,2}$<br>min | $s^1)$ | $d_a$<br>min | $D_a$<br>max | $r_a$<br>max |
|-----|-----|------------------|--------|--------------|--------------|--------------|
| mm  |     |                  |        | mm           |              |              |
| 240 | 265 | 2                | 2      | 249          | 291          | 2            |
| 260 | 285 | 2                | 2      | 269          | 311          | 2            |
| 280 | 305 | 2                | 2,5    | 289          | 341          | 2            |
| 300 | 330 | 2,1              | 2      | 311          | 369          | 2            |
| 320 | 350 | 2,1              | 2      | 331          | 389          | 2            |
| 340 | 370 | 2,1              | 2      | 351          | 409          | 2            |
| 360 | 390 | 2,1              | 2      | 371          | 429          | 2            |
| 380 | 415 | 2,1              | 2      | 391          | 469          | 2            |

<sup>1)</sup> Permissible axial displacement from normal position of one bearing ring in relation to the other

# Needle roller bearings with machined rings without flanges, without an inner ring

$F_w$  5 – 30 mm

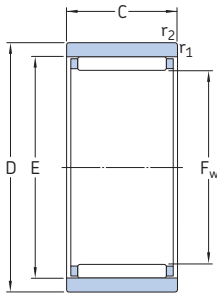

RNAO

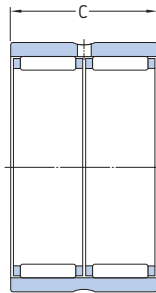

RNAO  
(double row)

| Principal dimensions |    |    | Basic load ratings |        | Fatigue load limit | Speed ratings   |                | Mass  | Designation                 |
|----------------------|----|----|--------------------|--------|--------------------|-----------------|----------------|-------|-----------------------------|
| $F_w$                | D  | C  | dynamic            | static | $P_u$              | Reference speed | Limiting speed |       |                             |
| mm                   |    |    | C                  | $C_0$  | kN                 | r/min           |                | kg    | –                           |
| 5                    | 10 | 8  | 2,29               | 2      | 0,212              | 36 000          | 40 000         | 0,003 | RNAO 5×10×8 TN              |
| 6                    | 13 | 8  | 2,55               | 2,36   | 0,25               | 34 000          | 38 000         | 0,006 | RNAO 6×13×8 TN              |
| 7                    | 14 | 8  | 2,81               | 2,75   | 0,29               | 32 000          | 36 000         | 0,006 | RNAO 7×14×8 TN              |
| 8                    | 15 | 10 | 3,8                | 4,25   | 0,465              | 32 000          | 36 000         | 0,008 | RNAO 8×15×10 TN             |
| 10                   | 17 | 10 | 4,57               | 5,7    | 0,63               | 28 000          | 32 000         | 0,010 | RNAO 10×17×10 TN            |
| 12                   | 22 | 12 | 9,52               | 10     | 1,18               | 26 000          | 30 000         | 0,019 | RNAO 12×22×12 TN            |
| 15                   | 23 | 13 | 8,09               | 10,8   | 1,25               | 24 000          | 28 000         | 0,020 | RNAO 15×23×13               |
| 16                   | 24 | 13 | 8,58               | 12     | 1,37               | 24 000          | 26 000         | 0,021 | RNAO 16×24×13               |
|                      | 28 | 12 | 11                 | 12,5   | 1,5                | 22 000          | 26 000         | 0,032 | RNAO 16×28×12               |
| 17                   | 25 | 13 | 10,1               | 14,6   | 1,73               | 22 000          | 26 000         | 0,022 | RNAO 17×25×13               |
| 18                   | 30 | 24 | 20,9               | 30     | 3,6                | 20 000          | 24 000         | 0,069 | RNAO 18×30×24 <sup>1)</sup> |
| 20                   | 28 | 13 | 9,52               | 14,6   | 1,66               | 20 000          | 22 000         | 0,025 | RNAO 20×28×13               |
|                      | 28 | 26 | 16,1               | 29     | 3,35               | 20 000          | 22 000         | 0,050 | RNAO 20×28×26 <sup>1)</sup> |
|                      | 32 | 12 | 12,8               | 16,3   | 1,96               | 19 000          | 22 000         | 0,038 | RNAO 20×32×12               |
| 22                   | 30 | 13 | 10,1               | 16,3   | 1,86               | 18 000          | 20 000         | 0,027 | RNAO 22×30×13               |
|                      | 35 | 16 | 19,4               | 25,5   | 3,05               | 17 000          | 19 000         | 0,059 | RNAO 22×35×16               |
| 25                   | 35 | 17 | 14,2               | 26,5   | 3,1                | 16 000          | 18 000         | 0,053 | RNAO 25×35×17               |
|                      | 35 | 26 | 18,7               | 37,5   | 4,3                | 16 000          | 18 000         | 0,076 | RNAO 25×35×26 <sup>1)</sup> |
|                      | 37 | 16 | 20,1               | 28     | 3,35               | 15 000          | 17 000         | 0,060 | RNAO 25×37×16               |
| 30                   | 40 | 17 | 18,7               | 34     | 4,05               | 13 000          | 15 000         | 0,060 | RNAO 30×40×17               |
|                      | 42 | 16 | 22                 | 33,5   | 4                  | 13 000          | 15 000         | 0,059 | RNAO 30×42×16               |
|                      | 42 | 32 | 38                 | 67     | 8                  | 13 000          | 15 000         | 0,14  | RNAO 30×42×32 <sup>1)</sup> |

<sup>1)</sup> Double row, outer ring with a lubrication hole and an annular groove



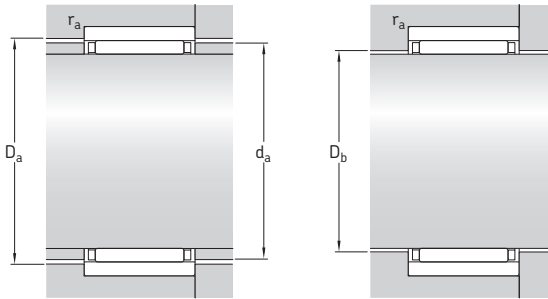

### Dimensions

### Abutment and fillet dimensions

| F <sub>w</sub> | E  | r <sub>1,2</sub><br>min | d <sub>a</sub> | D <sub>a</sub> | D <sub>b</sub> | r <sub>a</sub><br>max |
|----------------|----|-------------------------|----------------|----------------|----------------|-----------------------|
| mm             |    |                         | mm             |                |                |                       |
| 5              | 8  | 0,15                    | 7,7            | 8,3            | 5,3            | 0,1                   |
| 6              | 9  | 0,3                     | 8,7            | 9,3            | 6,3            | 0,3                   |
| 7              | 10 | 0,3                     | 9,7            | 10,3           | 7,3            | 0,3                   |
| 8              | 11 | 0,3                     | 10,7           | 11,3           | 8,3            | 0,3                   |
| 10             | 13 | 0,3                     | 12,7           | 13,3           | 10,3           | 0,3                   |
| 12             | 18 | 0,3                     | 17,6           | 18,3           | 12,3           | 0,3                   |
| 15             | 19 | 0,3                     | 18,6           | 19,3           | 15,4           | 0,3                   |
| 16             | 20 | 0,3                     | 19,6           | 20,3           | 16,4           | 0,3                   |
|                | 22 | 0,3                     | 21,6           | 22,3           | 16,4           | 0,3                   |
| 17             | 21 | 0,3                     | 20,6           | 21,3           | 17,4           | 0,3                   |
| 18             | 24 | 0,3                     | 23,6           | 24,5           | 18,4           | 0,3                   |
| 20             | 24 | 0,3                     | 23,6           | 24,3           | 20,4           | 0,3                   |
|                | 24 | 0,3                     | 23,6           | 24,3           | 20,4           | 0,3                   |
|                | 26 | 0,3                     | 25,6           | 26,5           | 20,4           | 0,3                   |
| 22             | 26 | 0,3                     | 25,6           | 26,3           | 22,4           | 0,3                   |
|                | 29 | 0,3                     | 28,4           | 29,5           | 22,4           | 0,3                   |
| 25             | 30 | 0,3                     | 29,4           | 30,5           | 25,6           | 0,3                   |
|                | 30 | 0,3                     | 29,4           | 30,5           | 25,6           | 0,3                   |
|                | 32 | 0,3                     | 31,4           | 32,5           | 25,6           | 0,3                   |
| 30             | 35 | 0,3                     | 34,4           | 35,5           | 30,6           | 0,3                   |
|                | 37 | 0,3                     | 36,4           | 37,5           | 30,6           | 0,3                   |
|                | 37 | 0,3                     | 36,4           | 37,5           | 30,6           | 0,3                   |

# Needle roller bearings with machined rings without flanges, without an inner ring

$F_w$  35 – 100 mm

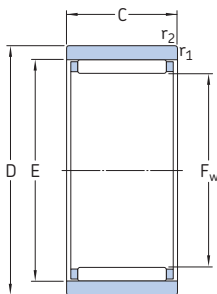

RNAO

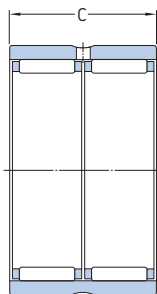

RNAO  
(double row)

| Principal dimensions |     |    | Basic load ratings |        | Fatigue load limit | Speed ratings   |                | Mass  | Designation                 |
|----------------------|-----|----|--------------------|--------|--------------------|-----------------|----------------|-------|-----------------------------|
| $F_w$                | D   | C  | dynamic            | static | $P_u$              | Reference speed | Limiting speed |       |                             |
| mm                   |     |    | C                  | $C_0$  | kN                 | r/min           |                | kg    | –                           |
| 35                   | 45  | 13 | 15,4               | 28     | 3,25               | 12 000          | 13 000         | 0,053 | RNAO 35×45×13               |
|                      | 45  | 17 | 19,8               | 39     | 4,65               | 12 000          | 13 000         | 0,069 | RNAO 35×45×17               |
|                      | 45  | 26 | 26,4               | 56     | 6,55               | 12 000          | 13 000         | 0,091 | RNAO 35×45×26 <sup>1)</sup> |
|                      | 47  | 16 | 23,3               | 37,5   | 4,5                | 11 000          | 13 000         | 0,078 | RNAO 35×47×16               |
|                      | 47  | 18 | 26,4               | 44     | 5,3                | 11 000          | 13 000         | 0,089 | RNAO 35×47×18               |
|                      | 47  | 32 | 40,2               | 75     | 9                  | 11 000          | 13 000         | 0,16  | RNAO 35×47×32 <sup>1)</sup> |
| 40                   | 50  | 17 | 20,5               | 41,5   | 5                  | 10 000          | 12 000         | 0,074 | RNAO 40×50×17               |
|                      | 50  | 34 | 35,2               | 83     | 10                 | 10 000          | 12 000         | 0,15  | RNAO 40×50×34 <sup>1)</sup> |
|                      | 55  | 20 | 31,4               | 57     | 6,95               | 10 000          | 11 000         | 0,15  | RNAO 40×55×20               |
|                      | 55  | 40 | 59,4               | 118    | 14,6               | 10 000          | 11 000         | 0,28  | RNAO 40×55×40 <sup>1)</sup> |
| 45                   | 55  | 17 | 21,6               | 46,5   | 5,6                | 9 000           | 10 000         | 0,083 | RNAO 45×55×17               |
|                      | 62  | 40 | 64,4               | 137    | 16,6               | 9 000           | 10 000         | 0,38  | RNAO 45×62×40 <sup>1)</sup> |
| 50                   | 62  | 20 | 25,5               | 60     | 7,2                | 8 500           | 9 500          | 0,14  | RNAO 50×62×20               |
|                      | 65  | 20 | 34,1               | 62     | 7,65               | 8 000           | 9 000          | 0,17  | RNAO 50×65×20               |
|                      | 65  | 40 | 58,3               | 125    | 15,3               | 8 000           | 9 000          | 0,36  | RNAO 50×65×40 <sup>1)</sup> |
| 55                   | 68  | 20 | 27                 | 67     | 8,15               | 7 500           | 8 500          | 0,17  | RNAO 55×68×20               |
| 60                   | 78  | 20 | 41,8               | 86,5   | 10,6               | 6 700           | 7 500          | 0,26  | RNAO 60×78×20               |
|                      | 78  | 40 | 72,1               | 173    | 21,2               | 6 700           | 7 500          | 0,44  | RNAO 60×78×40 <sup>1)</sup> |
| 65                   | 85  | 30 | 53,9               | 125    | 15,6               | 6 300           | 7 000          | 0,46  | RNAO 65×85×30               |
| 70                   | 90  | 30 | 57,2               | 137    | 17                 | 6 000           | 6 700          | 0,50  | RNAO 70×90×30               |
| 80                   | 100 | 30 | 68,2               | 176    | 22                 | 5 000           | 6 000          | 0,58  | RNAO 80×100×30              |
| 90                   | 105 | 26 | 58,3               | 150    | 18,6               | 4 500           | 5 300          | 0,37  | RNAO 90×105×26              |
|                      | 110 | 30 | 64,4               | 173    | 21,6               | 4 500           | 5 300          | 0,61  | RNAO 90×110×30              |
| 100                  | 120 | 30 | 67,1               | 190    | 23,6               | 4 000           | 4 800          | 0,69  | RNAO 100×120×30             |

<sup>1)</sup> Double row, outer ring with a lubrication hole and an annular groove

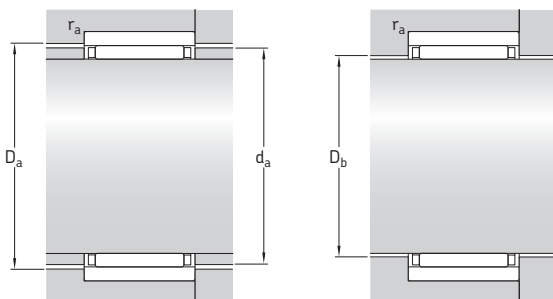

| Dimensions |     |                  | Abutment and fillet dimensions |       |       |              |
|------------|-----|------------------|--------------------------------|-------|-------|--------------|
| $F_w$      | E   | $r_{1,2}$<br>min | $d_a$                          | $D_a$ | $D_b$ | $r_a$<br>max |
| mm         |     |                  | mm                             |       |       |              |
| 35         | 40  | 0,3              | 39,4                           | 40,5  | 35,6  | 0,3          |
|            | 40  | 0,3              | 39,4                           | 40,5  | 35,6  | 0,3          |
|            | 40  | 0,3              | 39,4                           | 40,5  | 35,6  | 0,3          |
|            | 42  | 0,3              | 41,4                           | 42,5  | 35,8  | 0,3          |
|            | 42  | 0,3              | 41,4                           | 42,5  | 35,6  | 0,3          |
|            | 42  | 0,3              | 41,4                           | 42,5  | 35,6  | 0,3          |
| 40         | 45  | 0,3              | 44,4                           | 45,5  | 40,6  | 0,3          |
|            | 45  | 0,3              | 44,4                           | 45,5  | 40,6  | 0,3          |
|            | 47  | 0,3              | 46,2                           | 47,5  | 40,6  | 0,3          |
|            | 48  | 0,3              | 47,2                           | 47,5  | 40,6  | 0,3          |
| 45         | 50  | 0,3              | 49,4                           | 50,5  | 45,6  | 0,3          |
|            | 53  | 0,3              | 52,2                           | 53,5  | 46    | 0,3          |
| 50         | 55  | 0,3              | 54,4                           | 55,8  | 50,6  | 0,3          |
|            | 58  | 0,3              | 57,2                           | 58,5  | 51    | 0,3          |
|            | 58  | 0,3              | 57,2                           | 58,5  | 51    | 0,3          |
| 55         | 60  | 0,3              | 59,4                           | 60,8  | 55,6  | 0,3          |
| 60         | 68  | 1                | 67,2                           | 68,8  | 61    | 1            |
|            | 68  | 1                | 67,2                           | 68,8  | 61    | 1            |
| 65         | 73  | 1                | 72,2                           | 73,8  | 66    | 1            |
| 70         | 78  | 1                | 77,2                           | 78,8  | 71    | 1            |
| 80         | 88  | 1                | 87,2                           | 89    | 81    | 1            |
| 90         | 98  | 1                | 97,2                           | 99    | 91    | 1            |
|            | 98  | 1                | 97,2                           | 99    | 91    | 1            |
| 100        | 108 | 1                | 107,2                          | 109   | 101   | 1            |

# Needle roller bearings with machined rings without flanges, with an inner ring d 6 – 90 mm

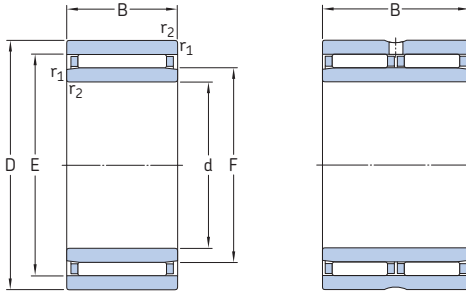

NAO

NAO  
(double row)

| Principal dimensions |                      |                      | Basic load ratings           |                        | Fatigue load limit         | Speed ratings                        |                                      | Mass                         | Designation                                                                |
|----------------------|----------------------|----------------------|------------------------------|------------------------|----------------------------|--------------------------------------|--------------------------------------|------------------------------|----------------------------------------------------------------------------|
| d                    | D                    | B                    | dynamic                      | static                 |                            | Reference speed                      | Limiting speed                       |                              |                                                                            |
| mm                   |                      |                      | C                            | C <sub>0</sub>         | P <sub>u</sub>             | r/min                                | kg                                   | –                            |                                                                            |
| 6                    | 17                   | 10                   | 4,57                         | 5,7                    | 0,63                       | 28 000                               | 32 000                               | 0,014                        | NAO 6×17×10 TN <sup>2)</sup>                                               |
| 9                    | 22                   | 12                   | 9,52                         | 10                     | 1,18                       | 26 000                               | 28 000                               | 0,024                        | NAO 9×22×12 TN                                                             |
| 12                   | 24<br>28             | 13<br>12             | 8,58<br>11                   | 12<br>12,5             | 1,37<br>1,5                | 24 000<br>22 000                     | 26 000<br>26 000                     | 0,030<br>0,040               | NAO 12×24×13<br>NAO 12×28×12 <sup>2)</sup>                                 |
| 15                   | 28<br>32             | 13<br>12             | 9,52<br>12,8                 | 14,6<br>16,3           | 1,66<br>1,96               | 20 000<br>19 000                     | 22 000<br>22 000                     | 0,029<br>0,050               | NAO 15×28×13<br>NAO 15×32×12 <sup>2)</sup>                                 |
| 17                   | 30<br>35             | 13<br>16             | 10,1<br>19,4                 | 16,3<br>25,5           | 1,86<br>3,05               | 18 000<br>17 000                     | 20 000<br>19 000                     | 0,042<br>0,078               | NAO 17×30×13<br>NAO 17×35×16                                               |
| 20                   | 35<br>37             | 17<br>16             | 14,2<br>20,1                 | 26,5<br>28             | 3,1<br>3,35                | 16 000<br>15 000                     | 18 000<br>17 000                     | 0,076<br>0,082               | NAO 20×35×17<br>NAO 20×37×16                                               |
| 25                   | 40<br>42<br>42       | 17<br>16<br>32       | 18,7<br>22<br>38             | 34<br>33,5<br>68       | 4,05<br>4<br>8,15          | 13 000<br>13 000<br>12 000           | 15 000<br>15 000<br>14 000           | 0,088<br>0,086<br>0,19       | NAO 25×40×17<br>NAO 25×42×16 <sup>2)</sup><br>NAO 25×42×32 <sup>2)</sup>   |
| 30                   | 45<br>45<br>47<br>47 | 17<br>26<br>16<br>18 | 19,8<br>26,4<br>23,3<br>26,4 | 39<br>56<br>37,5<br>44 | 4,65<br>6,55<br>4,5<br>5,3 | 12 000<br>12 000<br>11 000<br>11 000 | 13 000<br>13 000<br>13 000<br>13 000 | 0,10<br>0,16<br>0,11<br>0,12 | NAO 30×45×17<br>NAO 30×45×26 <sup>1)</sup><br>NAO 30×47×16<br>NAO 30×47×18 |
| 35                   | 50<br>55             | 17<br>20             | 20,5<br>31,4                 | 41,5<br>57             | 5<br>6,95                  | 10 000<br>10 000                     | 12 000<br>11 000                     | 0,11<br>0,19                 | NAO 35×50×17<br>NAO 35×55×20                                               |
| 40                   | 55                   | 17                   | 21,6                         | 46,5                   | 5,6                        | 9 000                                | 10 000                               | 0,13                         | NAO 40×55×17                                                               |
| 50                   | 68                   | 20                   | 27                           | 67                     | 8,15                       | 7 500                                | 8 500                                | 0,23                         | NAO 50×68×20 <sup>2)</sup>                                                 |
| 70                   | 100                  | 30                   | 68,2                         | 176                    | 22                         | 5 000                                | 6 000                                | 0,85                         | NAO 70×100×30                                                              |
| 80                   | 110                  | 30                   | 64,4                         | 173                    | 21,6                       | 4 500                                | 5 300                                | 0,92                         | NAO 80×110×30                                                              |
| 90                   | 120                  | 30                   | 67,1                         | 190                    | 23,6                       | 4 000                                | 4 800                                | 1,05                         | NAO 90×120×30                                                              |

<sup>1)</sup> Double row, outer ring with a lubrication hole and an annular groove

<sup>2)</sup> One lubrication hole in the inner ring

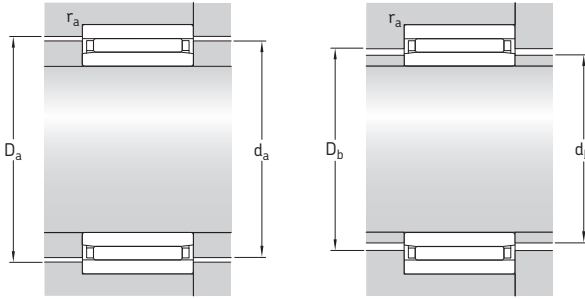

| Dimensions |     |     |                         |                 | Abutment and fillet dimensions |                |                |                |                       |
|------------|-----|-----|-------------------------|-----------------|--------------------------------|----------------|----------------|----------------|-----------------------|
| d          | E   | F   | r <sub>1,2</sub><br>min | s <sup>3)</sup> | d <sub>a</sub>                 | d <sub>b</sub> | D <sub>a</sub> | D <sub>b</sub> | r <sub>a</sub><br>max |
| mm         |     |     |                         |                 | mm                             |                |                | –              |                       |
| <b>6</b>   | 13  | 10  | 0,3                     | 0,5             | 12,7                           | 9,7            | 13,3           | 10,3           | 0,3                   |
| <b>9</b>   | 18  | 12  | 0,3                     | 0,5             | 17,6                           | 11,7           | 18,3           | 12,3           | 0,3                   |
| <b>12</b>  | 20  | 16  | 0,3                     | 0,5             | 19,6                           | 15,7           | 20,3           | 16,4           | 0,3                   |
|            | 22  | 16  | 0,3                     | 0,5             | 21,6                           | 15,7           | 22,3           | 16,6           | 0,3                   |
| <b>15</b>  | 24  | 20  | 0,3                     | 0,5             | 23,6                           | 19,5           | 24,3           | 20,4           | 0,3                   |
|            | 26  | 20  | 0,3                     | 0,5             | 25,6                           | 19,5           | 26,5           | 20,6           | 0,3                   |
| <b>17</b>  | 26  | 22  | 0,3                     | 0,5             | 25,6                           | 21,5           | 26,3           | 22,4           | 0,3                   |
|            | 29  | 22  | 0,3                     | 0,5             | 28,4                           | 21,5           | 29,5           | 22,6           | 0,3                   |
| <b>20</b>  | 30  | 25  | 0,3                     | 0,5             | 29,4                           | 24,5           | 30,5           | 25,6           | 0,3                   |
|            | 32  | 25  | 0,3                     | 0,5             | 31,4                           | 24,5           | 32,5           | 25,6           | 0,3                   |
| <b>25</b>  | 35  | 30  | 0,3                     | 0,8             | 34,4                           | 29,5           | 35,5           | 30,6           | 0,3                   |
|            | 37  | 30  | 0,3                     | 0,8             | 36,4                           | 29,5           | 37,5           | 30,6           | 0,3                   |
|            | 37  | 30  | 0,3                     | 0,8             | 36,4                           | 29,5           | 37,5           | 30,6           | 0,3                   |
| <b>30</b>  | 40  | 35  | 0,3                     | 0,8             | 39,4                           | 34,5           | 40,5           | 35,6           | 0,3                   |
|            | 40  | 35  | 0,3                     | 0,8             | 39,4                           | 34,5           | 40,5           | 35,6           | 0,3                   |
|            | 42  | 35  | 0,3                     | 0,8             | 41,4                           | 34,5           | 42,5           | 35,6           | 0,3                   |
|            | 42  | 35  | 0,3                     | 0,8             | 41,4                           | 34,5           | 42,5           | 35,6           | 0,3                   |
| <b>35</b>  | 45  | 40  | 0,3                     | 0,8             | 44,4                           | 39,5           | 45,5           | 40,6           | 0,3                   |
|            | 48  | 40  | 0,3                     | 0,8             | 46,2                           | 39,5           | 47,5           | 40,6           | 0,3                   |
| <b>40</b>  | 50  | 45  | 0,3                     | 0,8             | 49,2                           | 44,5           | 50,5           | 45,6           | 0,3                   |
| <b>50</b>  | 60  | 55  | 0,6                     | 1               | 59,2                           | 54,5           | 60,8           | 55,8           | 0,6                   |
| <b>70</b>  | 88  | 80  | 1                       | 1               | 87,2                           | 79,3           | 89             | 81             | 1                     |
| <b>80</b>  | 98  | 90  | 1                       | 1               | 97,2                           | 89,3           | 99             | 91             | 1                     |
| <b>90</b>  | 108 | 100 | 1                       | 1               | 107,2                          | 99,3           | 109            | 101            | 1                     |

<sup>3)</sup> Permissible axial displacement from normal position of one bearing ring relative to the other



# Alignment needle roller bearings

|                                                                 |     |
|-----------------------------------------------------------------|-----|
| <b>Dimensions</b> .....                                         | 142 |
| <b>Tolerances</b> .....                                         | 143 |
| <b>Internal clearance</b> .....                                 | 143 |
| <b>Misalignment</b> .....                                       | 143 |
| <b>Permissible operating temperature</b> .....                  | 143 |
| <b>Cages</b> .....                                              | 144 |
| <b>Shaft and housing tolerances</b> .....                       | 144 |
| <b>Mounting instructions</b> .....                              | 145 |
| <b>Product tables</b> .....                                     | 146 |
| 5.1 Alignment needle roller bearings without an inner ring..... | 146 |
| 5.2 Alignment needle roller bearings with an inner ring.....    | 148 |

## Alignment needle roller bearings

Alignment needle roller bearings have an outer ring with a convex sphered outside surface. Two polymer seating rings with a concave sphered inside surface that is encased in a drawn sheet steel sleeve are fitted over the outer ring, enabling the bearing to align itself. Alignment needle roller bearings are therefore insensitive to static misalignment of the shaft relative to the housing.

SKF supplies alignment needle roller bearings without an inner ring (→ **fig. 1**) and with an inner ring (→ **fig. 2**). Bearings without an inner ring provide the optimum solution for compact arrangements if the shaft can be hardened and ground. In applications where it is not possible or uneconomical to harden and grind the shaft, bearings with an inner ring should be used.

Bearings with an inner ring permit axial displacement of the shaft relative to the housing within certain limits (→ **product table**). If greater axial displacements are anticipated, extended inner rings that are wider than standard inner rings can be used.

See chapter *Needle roller bearing inner rings*, starting on **page 196**.

The bearings are supplied without grease and not sealed. Depending on the application, they can be grease or oil lubricated.

The ends of the needle rollers are slightly relieved. The resulting modified line contact between the rollers and raceways means that the load distribution in the bearing is improved.

## Dimensions

The dimensions of alignment needle roller bearings have not been standardized. However, with the exception of bearings with a 52 mm outside diameter, the inner ring bore and outside diameter are standardized, in accordance with ISO 15:1998, as follows:

- bearings with an outside diameter  $D \leq 47$  mm follow Diameter Series 0
- bearings with an outside diameter  $D \geq 55$  mm follow Diameter Series 9

Fig. 1

Alignment needle roller bearing without an inner ring

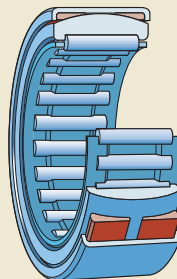

RPNA series

Fig. 2

Alignment needle roller bearing with an inner ring

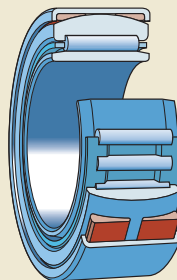

PNA series



# Tolerances

Inner rings, as well as outer rings with a sphered outside surface are manufactured to Normal tolerances in accordance with ISO 492:2002.

The tolerance for the width of the external drawn sheet steel sleeve is  $\pm 0,5$  mm.

## Internal clearance

SKF alignment needle roller bearings with an inner ring have Normal radial internal clearance as standard. The clearance values are listed in **table 7** on **page 42** and are in accordance with ISO 5753-1:2009. They are valid for unmounted bearings under zero measuring load.

SKF alignment needle roller bearings without an inner ring have an inside diameter  $F_w$  that lies within F6 tolerance class when the bearing is unmounted and the rollers are in contact with the outer ring raceway. If the recommended tolerance classes ( $\rightarrow$  **table 1**) are applied, the operational clearance will reach a value in the range of C2 to Normal radial internal clearance ( $\rightarrow$  **table 7, page 42**).

## Misalignment

Alignment needle roller bearings can compensate static misalignment up to  $3^\circ$  between the shaft and housing. These bearings are unable to accommodate any dynamic misalignment.

## Permissible operating temperature

Due to the polymer seating ring material, the permissible operating temperature range for alignment needle roller bearings is  $-30$  to  $+100$  °C.

Table 1

### Shaft and housing tolerance classes

| Housing material | Tolerance classes |                       |               |
|------------------|-------------------|-----------------------|---------------|
|                  | Housing bore seat | Shaft inner ring seat | Shaft raceway |
| Steel, cast iron | N6                | k5                    | h5            |
|                  | N7                | j6                    | h6            |
| Light alloy      | R6                | k5                    | h5            |
|                  | R7                | j6                    | h6            |

### Cages

SKF alignment needle roller bearings are fitted with a machined steel (→ **fig. 3**) or a sheet steel cage (→ **fig. 4**), with adequate free space for lubricant.

### Shaft and housing tolerances

Alignment needle roller bearings are mounted with an interference fit in the housing bore. Therefore, shoulders or snap rings are not required to locate the bearing axially so the design of the housing bore is simple and can be produced economically.

If the recommended housing bore tolerance classes listed in **table 1** on **page 143** are applied, alignment movements between the outer ring and the sleeve will be possible. These tolerances, together with the tolerance classes recommended for the inner ring shaft seats or for raceways on the shaft, will reach an operational clearance value in the range of C2 to Normal radial internal clearance (→ **table 7**, **page 42**).

Fig. 3

Machined steel cage



Fig. 4

Sheet steel cage



## Mounting instructions

When mounting alignment needle roller bearings, the inner ring should be mounted separately. The outer ring and the polymer seating rings with sleeve and needle roller and cage assembly should be mounted with a mounting dolly (→ **fig. 5**). An O-ring provides a simple means of retaining the bearing on the mounting dolly. The stamped side face should abut the flange of the mounting dolly.

### Note

When using grease, the bearing should be lubricated before mounting. Special care should be taken to prevent the sleeve from skewing or tilting when it is being pressed into the housing. Otherwise the rollers and raceways could easily be damaged.

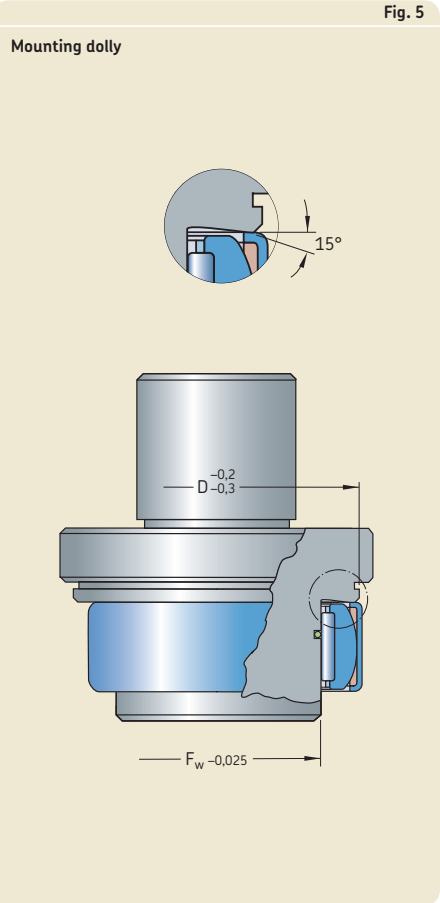

## Alignment needle roller bearings without an inner ring

$F_w$  15 – 45 mm

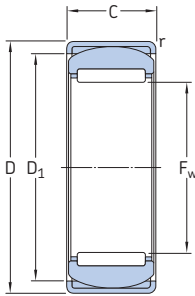

RPNA

| Principal dimensions |    |    | Basic load ratings |                 | Fatigue load limit<br>$P_u$ | Speed ratings      |                   | Mass<br>kg | Designation       |
|----------------------|----|----|--------------------|-----------------|-----------------------------|--------------------|-------------------|------------|-------------------|
| $F_w$                | D  | C  | dynamic<br>C       | static<br>$C_0$ |                             | Reference<br>speed | Limiting<br>speed |            |                   |
| mm                   |    |    | kN                 |                 | kN                          | r/min              |                   |            | –                 |
| <b>15</b>            | 28 | 12 | 7,37               | 9,15            | 1,08                        | 24 000             | 28 000            | 0,032      | <b>RPNA 15/28</b> |
| <b>18</b>            | 32 | 16 | 12,8               | 17,6            | 2,12                        | 22 000             | 24 000            | 0,052      | <b>RPNA 18/32</b> |
| <b>20</b>            | 35 | 16 | 13,2               | 19,3            | 2,28                        | 19 000             | 22 000            | 0,062      | <b>RPNA 20/35</b> |
| <b>25</b>            | 42 | 20 | 19                 | 32,5            | 4                           | 16 000             | 18 000            | 0,11       | <b>RPNA 25/42</b> |
| <b>28</b>            | 44 | 20 | 22                 | 36,5            | 4,55                        | 14 000             | 16 000            | 0,11       | <b>RPNA 28/44</b> |
| <b>30</b>            | 47 | 20 | 22,9               | 38              | 4,8                         | 13 000             | 15 000            | 0,13       | <b>RPNA 30/47</b> |
| <b>35</b>            | 52 | 20 | 24,6               | 45              | 5,6                         | 11 000             | 13 000            | 0,13       | <b>RPNA 35/52</b> |
| <b>40</b>            | 55 | 20 | 26,4               | 51              | 6,3                         | 10 000             | 11 000            | 0,14       | <b>RPNA 40/55</b> |
| <b>45</b>            | 62 | 20 | 27,5               | 57              | 7,1                         | 9 000              | 10 000            | 0,18       | <b>RPNA 45/62</b> |

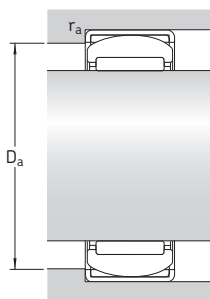

### Dimensions

### Abutment and fillet dimensions

| $F_w$ | $D_1$ | $r_{\min}$ | $D_a$<br>min | $D_a$<br>max | $r_a$<br>max |
|-------|-------|------------|--------------|--------------|--------------|
| mm    |       |            | mm           |              |              |
| 15    | 24,5  | 1          | 23,5         | 24,5         | 1            |
| 18    | 27    | 1          | 26           | 27           | 1            |
| 20    | 30,5  | 1          | 29,5         | 30,5         | 1            |
| 25    | 36,5  | 1          | 35           | 37           | 1            |
| 28    | 38,5  | 1          | 37,5         | 39           | 1            |
| 30    | 42    | 1          | 41           | 42           | 1            |
| 35    | 47,5  | 1          | 46,5         | 47,5         | 1            |
| 40    | 50,5  | 1          | 49,5         | 50,5         | 1            |
| 45    | 58    | 1          | 57           | 58           | 1            |

**Alignment needle roller bearings with an inner ring**  
**d 12 – 40 mm**

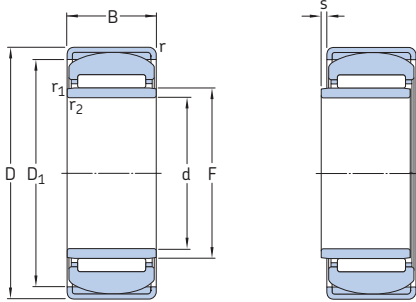

PNA

PNA

| Principal dimensions |    |    | Basic load ratings |        | Fatigue load limit | Speed ratings   |                | Mass  | Designation      |
|----------------------|----|----|--------------------|--------|--------------------|-----------------|----------------|-------|------------------|
| d                    | D  | B  | dynamic            | static |                    | Reference speed | Limiting speed |       |                  |
| mm                   |    |    | kN                 |        | kN                 | r/min           | kg             | –     |                  |
| <b>12</b>            | 28 | 12 | 7,37               | 9,15   | 1,08               | 24 000          | 28 000         | 0,037 | <b>PNA 12/28</b> |
| <b>15</b>            | 32 | 16 | 12,8               | 17,6   | 2,12               | 22 000          | 24 000         | 0,062 | <b>PNA 15/32</b> |
| <b>17</b>            | 35 | 16 | 13,2               | 19,3   | 2,28               | 19 000          | 22 000         | 0,073 | <b>PNA 17/35</b> |
| <b>20</b>            | 42 | 20 | 19                 | 32,5   | 4                  | 16 000          | 18 000         | 0,14  | <b>PNA 20/42</b> |
| <b>22</b>            | 44 | 20 | 22                 | 36,5   | 4,55               | 14 000          | 16 000         | 0,15  | <b>PNA 22/44</b> |
| <b>25</b>            | 47 | 20 | 22,9               | 38     | 4,8                | 13 000          | 15 000         | 0,16  | <b>PNA 25/47</b> |
| <b>30</b>            | 52 | 20 | 24,6               | 45     | 5,6                | 11 000          | 13 000         | 0,18  | <b>PNA 30/52</b> |
| <b>35</b>            | 55 | 20 | 26,4               | 51     | 6,3                | 10 000          | 11 000         | 0,18  | <b>PNA 35/55</b> |
| <b>40</b>            | 62 | 20 | 27,5               | 57     | 7,1                | 9 000           | 10 000         | 0,23  | <b>PNA 40/62</b> |

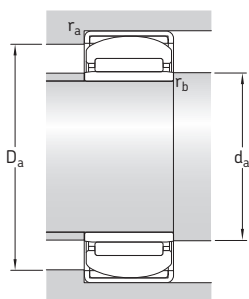

| Dimensions |    |                |                  |                      |                 | Abutment and fillet dimensions |                    |                    |                    |                    |
|------------|----|----------------|------------------|----------------------|-----------------|--------------------------------|--------------------|--------------------|--------------------|--------------------|
| d          | F  | D <sub>1</sub> | r <sub>min</sub> | r <sub>1,2 min</sub> | s <sup>1)</sup> | d <sub>a min</sub>             | D <sub>a min</sub> | D <sub>a max</sub> | r <sub>a max</sub> | r <sub>b max</sub> |
| mm         |    |                |                  |                      |                 | mm                             |                    |                    |                    |                    |
| 12         | 15 | 24,5           | 1                | 0,3                  | 0,5             | 14                             | 23,5               | 24,5               | 1                  | 0,3                |
| 15         | 18 | 27             | 1                | 0,3                  | 0,5             | 17                             | 26                 | 27                 | 1                  | 0,3                |
| 17         | 20 | 30,5           | 1                | 0,3                  | 0,5             | 19                             | 29,5               | 30,5               | 1                  | 0,3                |
| 20         | 25 | 36,5           | 1                | 0,3                  | 0,5             | 22                             | 35                 | 37                 | 1                  | 0,3                |
| 22         | 28 | 38,5           | 1                | 0,3                  | 0,5             | 24                             | 37,5               | 39                 | 1                  | 0,3                |
| 25         | 30 | 42             | 1                | 0,3                  | 0,5             | 25                             | 41                 | 42                 | 1                  | 0,3                |
| 30         | 35 | 47,5           | 1                | 0,3                  | 0,5             | 32                             | 46,5               | 47,5               | 1                  | 0,3                |
| 35         | 40 | 50,5           | 1                | 0,3                  | 0,5             | 37                             | 49,5               | 50,5               | 1                  | 0,3                |
| 40         | 45 | 58             | 1                | 0,3                  | 0,5             | 42                             | 57                 | 58                 | 1                  | 0,3                |

<sup>1)</sup> Permissible axial displacement from normal position of one bearing ring in relation to the other





# Needle roller thrust bearings and bearing washers

|                                                                                        |            |
|----------------------------------------------------------------------------------------|------------|
| Needle roller and cage thrust assemblies, AXK series.....                              | 153        |
| Needle roller thrust bearings with a centring spigot, AXW series .....                 | 154        |
| Bearing washers .....                                                                  | 154        |
| Dimensions.....                                                                        | 157        |
| Tolerances .....                                                                       | 157        |
| Misalignment.....                                                                      | 157        |
| Cages .....                                                                            | 158        |
| Design of associated components .....                                                  | 159        |
| Raceways on a shaft and in a housing .....                                             | 160        |
| Supplementary designations.....                                                        | 160        |
| <b>Product tables</b> .....                                                            | <b>162</b> |
| 6.1 Needle roller and cage thrust assemblies and appropriate washers .....             | 162        |
| 6.2 Needle roller thrust bearings with a centring spigot and appropriate washers ..... | 166        |

## Needle roller thrust bearings and bearing washers

SKF needle roller thrust bearings are fitted with a form-stable cage to reliably guide and retain a large number of needle rollers. The diameter deviations of the rollers within one assembly are within  $2\ \mu\text{m}$ , enabling these bearings to accommodate heavy axial loads and shock loads. These bearings provide a high degree of stiffness within a minimum axial space. In applications where the faces of adjacent machine components can serve as raceways, needle roller thrust bearings will take up no more space than a conventional thrust washer. They can accommodate axial loads acting in one direction only. SKF supplies needle roller thrust bearings in two designs:

- needle roller and cage thrust assemblies, AXK series (→ **fig. 1**)
- needle roller thrust bearings with a centring spigot, AXW series (→ **fig. 2**)

For applications where adjacent components cannot serve as raceways, the assemblies can also be combined with washers of various designs.

Fig. 1

Needle roller and cage thrust assembly

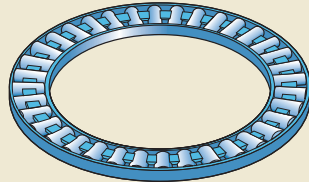

AXK series

Fig. 2

Needle roller thrust bearing with a centring spigot

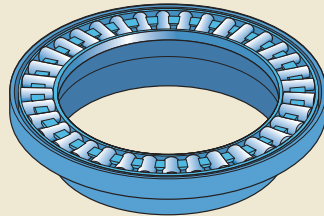

AXW series

## Needle roller and cage thrust assemblies, AXK series

SKF needle roller and cage thrust assemblies in the AXK series (→ **fig. 1**) range from a 4 to 160 mm bore. If required, washers in the LS, AS, GS 811 or WS 811 series can be used with these assemblies.

### Double direction bearings

A double direction needle roller thrust bearing can be created by combining two needle roller and cage thrust assemblies and bearing washers with an intermediate washer. Depending on the design of the intermediate washer, the bearing has internal centring (→ **fig. 3**) or external centring (→ **fig. 4**).

The intermediate washers must have the same surface finish and hardness as the bearing washers. For additional information, refer to the section *Design of associated components*, starting on **page 48**. SKF does not supply intermediate washers, but recommendations about suitable dimensions of the washers can be supplied on request.

Fig. 3

Double direction bearing arrangement with internal centring

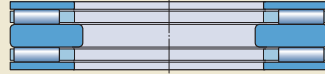
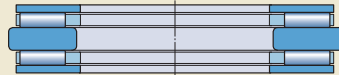

Fig. 4

Double direction bearing arrangement with external centring



## Needle roller thrust bearings with a centring spigot, AXW series

SKF needle roller thrust bearings in the AXW series (→ **fig. 2**, **page 152**) consist of a needle roller and cage thrust assembly and a thrust washer with a centring spigot. The spigot facilitates the mounting process of the thrust bearing and provides an accurate radial centring of the housing washer. Available bore sizes for the thrust assembly range from 10 to 50 mm.

### Combination with radial needle roller bearings

To accommodate combined radial and axial loads, AXW series needle roller thrust bearings can be combined with the following radial needle roller bearings:

- drawn cup needle roller bearings with a closed end or with open ends (→ **fig. 5**)
- needle roller bearings with machined rings (→ **fig. 6**)

These arrangements provide an economical and compact solution for combined loads.

## Bearing washers

SKF bearing washers are required in cases where adjacent machine components cannot serve as raceways.

Available bore sizes for washers in the LS series range from 6 to 160 mm and in the AS series from 4 to 160 mm.

Washers in the LS and AS series can be used as a shaft washer (for AXK or AXW series needle roller thrust assemblies) or housing washer (for AXK series needle roller thrust assemblies).

Because of all the possible combinations, the appropriate washers must be ordered separately.

### Raceway washers, LS series

Raceway washers in the LS series (→ **fig. 7**) are made of carbon chromium (rolling bearing) steel and are hardened. The raceway is ground and the bore and outside diameter are turned. These

Fig. 5

Needle roller thrust bearing, AXW series, combined with a drawn cup needle roller bearing

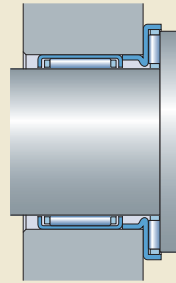

Fig. 6

Needle roller thrust bearings, AXW series, combined with a needle roller bearing with machined rings

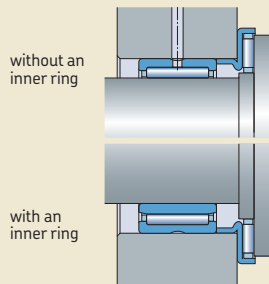
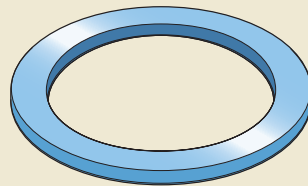

Fig. 7

Raceway washer



LS series

washers are used for bearing arrangements where accurate centring of the washers is not necessary or where low speeds are involved. The side face with the smaller chamfers is the raceway, and should face the rollers.

### Thrust washers, AS series

Thrust washers in the AS series (→ **fig. 8**) are made of spring steel and are 1 mm thick. Both sides of these washers, which are hardened and polished, can be used as raceways. If adjacent machine components are not hardened but have adequate stiffness and the running accuracy requirements are moderate, washers in the AS series can be used to provide a cost-effective bearing arrangement.

### Shaft and housing washers, WS 811 and GS 811 series

Shaft washers in the WS 811 series (→ **fig. 9**) and housing washers in the GS 811 series (→ **fig. 10**) are developed primarily for applications with cylindrical roller and cage thrust assemblies, but they can also be combined with needle roller and cage thrust assemblies. These washers, made of carbon chromium bearing steel are hardened and have precision machined raceways. Therefore, SKF recommends using these shaft and housing washers in high-speed applications where accurate centring of the bearing washers is required. WS 811 series shaft washers, which have a ground bore, are available in bore sizes ranging from 15 to 630 mm. When combined with needle roller and cage thrust assemblies, bore sizes up to 160 mm are used. GS 811 series housing washers, which have a ground outside diameter, are available for housing bore diameters ranging from 28 mm to 750 mm. When combined with needle roller and cage thrust assemblies, outside diameter sizes up to 200 mm are used.

Fig. 8

Thrust washer

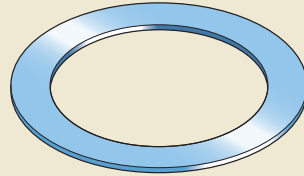

AS series

Fig. 9

Shaft washer

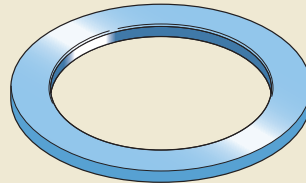

WS 811 series

Fig. 10

Housing washer

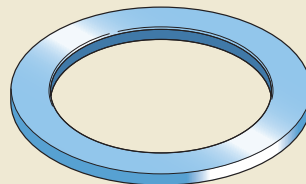

GS 811 series

Table 1

Tolerances for needle roller thrust bearings

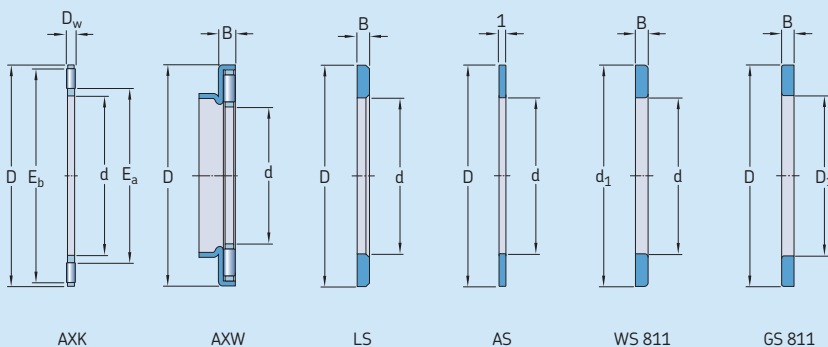

| Bearing component                                                | Tolerance, tolerance class |                        |
|------------------------------------------------------------------|----------------------------|------------------------|
| Dimensions                                                       |                            |                        |
| <b>Needle roller and cage thrust assemblies, AXK</b>             |                            |                        |
| Bore diameter                                                    | d                          | E12                    |
| Outside diameter                                                 | D                          | c13                    |
| Roller diameter                                                  | D <sub>w</sub>             | Grade 2, ISO 3096:1996 |
| <b>Needle roller thrust bearings with a centring spigot, AXW</b> |                            |                        |
| Bore diameter                                                    | d                          | E12                    |
| Outside diameter                                                 | D                          | -                      |
| Thickness                                                        | B                          | 0/-0,2 mm              |
| Roller diameter                                                  | D <sub>w</sub>             | Grade 2, ISO 3096:1996 |
| <b>Raceway washers, LS</b>                                       |                            |                        |
| Bore diameter                                                    | d                          | E12                    |
| Outside diameter                                                 | D                          | a12                    |
| Thickness                                                        | B                          | h11                    |
| Axial runout                                                     | s <sub>i</sub>             | Normal, ISO 199:2005   |
| <b>Thrust washers, AS</b>                                        |                            |                        |
| Bore diameter                                                    | d                          | E13                    |
| Outside diameter                                                 | D                          | e13                    |
| Thickness                                                        | B <sub>1</sub>             | ±0,05 mm               |
| <b>Shaft washers, WS 811</b>                                     |                            |                        |
| Bore diameter                                                    | d                          | Normal, ISO 199:2005   |
| Outside diameter                                                 | d <sub>1</sub>             | -                      |
| Thickness                                                        | B                          | h11                    |
| Axial runout                                                     | s <sub>i</sub>             | Normal, ISO 199:2005   |
| <b>Housing washer, GS 811</b>                                    |                            |                        |
| Outside diameter                                                 | D                          | Normal, ISO 199:2005   |
| Bore diameter                                                    | D <sub>1</sub>             | -                      |
| Thickness                                                        | B                          | h11                    |
| Axial runout                                                     | s <sub>e</sub>             | Normal, ISO 199:2005   |

Table 2

## ISO tolerance classes

| Nominal dimension | incl.      | a12 Deviations |        | c13 Deviations |      | e13 Deviations |      | h11 Deviations |      | E12 Deviations |      | E13 Deviations |      |
|-------------------|------------|----------------|--------|----------------|------|----------------|------|----------------|------|----------------|------|----------------|------|
|                   |            | high           | low    | high           | low  | high           | low  | high           | low  | high           | low  | high           | low  |
| mm                |            | µm             |        | µm             |      | µm             |      | µm             |      | µm             |      | µm             |      |
| –                 | <b>3</b>   | –270           | –370   | –60            | –200 | –14            | –154 | 0              | –60  | +114           | +14  | +154           | +14  |
| <b>3</b>          | <b>6</b>   | –270           | –390   | –70            | –250 | –20            | –200 | 0              | –75  | +140           | +20  | +200           | +20  |
| <b>6</b>          | <b>10</b>  | –280           | –430   | –80            | –300 | –25            | –245 | 0              | –90  | +175           | +25  | +245           | +25  |
| <b>10</b>         | <b>18</b>  | –290           | –470   | –95            | –365 | –32            | –302 | 0              | –110 | +212           | +32  | +302           | +32  |
| <b>18</b>         | <b>30</b>  | –300           | –510   | –110           | –440 | –40            | –370 | 0              | –130 | +250           | +40  | +370           | +40  |
| <b>30</b>         | <b>40</b>  | –310           | –560   | –120           | –510 | –50            | –440 | 0              | –160 | +300           | +50  | +440           | +50  |
| <b>40</b>         | <b>50</b>  | –320           | –570   | –130           | –520 | –50            | –440 | 0              | –160 | +300           | +50  | +440           | +50  |
| <b>50</b>         | <b>65</b>  | –340           | –640   | –140           | –600 | –60            | –520 | 0              | –190 | +360           | +60  | +520           | +60  |
| <b>65</b>         | <b>80</b>  | –360           | –660   | –150           | –610 | –60            | –520 | 0              | –190 | +360           | +60  | +520           | +60  |
| <b>80</b>         | <b>100</b> | –380           | –730   | –170           | –710 | –72            | –612 | 0              | –220 | +422           | +72  | +612           | +72  |
| <b>100</b>        | <b>120</b> | –410           | –760   | –180           | –720 | –72            | –612 | 0              | –220 | +422           | +72  | +612           | +72  |
| <b>120</b>        | <b>140</b> | –460           | –860   | –200           | –830 | –85            | –715 | 0              | –250 | +485           | +85  | +715           | +85  |
| <b>140</b>        | <b>160</b> | –520           | –920   | –210           | –840 | –85            | –715 | 0              | –250 | +485           | +85  | +715           | +85  |
| <b>160</b>        | <b>180</b> | –580           | –980   | –230           | –860 | –85            | –715 | 0              | –250 | +485           | +85  | +715           | +85  |
| <b>180</b>        | <b>200</b> | –660           | –1 120 | –240           | –960 | –100           | –820 | 0              | –290 | +560           | +100 | +820           | +100 |

## Dimensions

The dimensions of needle roller and cage thrust assemblies and thrust washers in the AS series are in accordance with ISO 3031:2000.

The bore and outside diameters of the other bearing washers are in accordance with ISO 104:2002 for Diameter Series 1 thrust bearings.

## Tolerances

Needle roller and cage thrust assemblies, needle roller thrust bearings with a spigot, and bearing washers are manufactured to the tolerance classes listed in **table 1**. The values for the dimension deviations of the various ISO tolerance classes mentioned in **table 1** are listed in **table 2**.

## Misalignment

Needle roller thrust bearings cannot tolerate any angular misalignment between the shaft and the housing, or any misalignment between the shaft and the axial support surfaces in the housing.

The ends of the needle rollers are relieved slightly to modify the line contact between the raceways and the rollers. This provides favourable load distribution in the bearing and minimizes damaging edge stresses.

### Cages

SKF needle roller and cage thrust assemblies are fitted as standard with a form-stable, machined steel cage (→ **fig. 11**) or a sheet steel cage (→ **fig. 12**), except for those identified by the designation suffix TN. These assemblies have an injection moulded, glass fibre reinforced, polyamide 66 cage (→ **fig. 13**).

The complete range of needle roller thrust bearings with a centring spigot in the AXW series are fitted exclusively with steel cages.

#### Note

Assemblies with a polyamide 66 cage can be used at temperatures up to +120 °C.

The lubricants generally used for rolling bearings do not have a detrimental effect on cage properties. Exceptions are a few synthetic oils and greases with a synthetic oil base and lubricants containing a high proportion of EP additives when used at high temperatures.

For bearing arrangements that will operate at continuously high temperatures or under arduous conditions, SKF recommends using needle roller and cage thrust assemblies with a steel cage.

For detailed information about the temperature resistance and the applicability of cages, refer to the section *Cage materials*, starting on **page 44**.

Fig. 11

Needle roller and cage thrust assembly with a machined steel cage



Fig. 12

Needle roller and cage thrust assembly with a sheet steel cage



Fig. 13

Needle roller and cage thrust assembly with a polyamide 66 cage





Table 3

## Shaft and housing tolerance classes

| Thrust bearing component                 | Series | Shaft tolerance class<br>Internal guidance/<br>centring | Housing tolerance class<br>External guidance/<br>centring |
|------------------------------------------|--------|---------------------------------------------------------|-----------------------------------------------------------|
| Needle roller and cage thrust assemblies | AXK    | h8                                                      | –                                                         |
| Raceway washers                          | LS     | h8<br>radial space                                      | radial space<br>H9                                        |
| Thrust washers                           | AS     | h8<br>radial space                                      | radial space<br>H9                                        |
| Shaft washers                            | WS 811 | h8                                                      | –                                                         |
| Housing washers                          | GS 811 | –                                                       | H9                                                        |

## Design of associated components

The support surfaces in the housing and on the shaft must be at right angles to the shaft axis and should provide uninterrupted support for the bearing washers across the entire width of the raceways. When using thrust washers in the AS series, the dimensions  $E_a$  and  $E_b$  listed in the product tables should be applied.

To provide satisfactory radial guidance for the individual thrust bearing components, suitable tolerance classes for shafts and housings are listed in **table 3**. Radial space between the shaft and the bore is required for washers that are externally guided in the housing. For washers that are internally guided on the shaft, radial space in the housing bore is required.

When SKF needle roller and cage thrust assemblies in the AXW series are combined with drawn cup needle roller bearings or needle roller bearings, the same housing tolerance must be selected for the centring spigot as for the radial bearing.

Needle roller and cage thrust assemblies are generally guided radially on the shaft in order to obtain the lowest possible sliding speed against the guiding surfaces. At high speeds, radial guidance must be provided by the shaft and the guiding surface must be ground.

## Raceways on a shaft and in a housing

For detailed information about suitable materials as well as surface hardness and surface finish, refer to the section *Raceways on shafts and in housings*, starting on **page 50**.

Raceways machined on the shaft or in the housing should have the same axial runout as is common for shaft or housing washers. The values for the permissible axial runout for the shaft and housing washers of thrust bearings are listed in **table 4**.

## Supplementary designations

The designation suffixes used to identify certain features of SKF needle roller thrust bearings are explained in the following.

**TN** Injection moulded cage of glass fibre reinforced polyamide 66

Table 4

## Normal tolerances for thrust bearings

## Shaft washer, WS 811

| d          | over       | incl. | $\Delta_{dmp}$ |     | $V_{dp}$      | $S_f^{1)}$    | $\Delta_{Ts}^{1)}$ |      |
|------------|------------|-------|----------------|-----|---------------|---------------|--------------------|------|
|            |            |       | high           | low | max           | max           | high               | low  |
| mm         |            |       | $\mu\text{m}$  |     | $\mu\text{m}$ | $\mu\text{m}$ | $\mu\text{m}$      |      |
| –          | <b>18</b>  |       | 0              | –8  | 6             | 10            | +20                | –250 |
| <b>18</b>  | <b>30</b>  |       | 0              | –10 | 8             | 10            | +20                | –250 |
| <b>30</b>  | <b>50</b>  |       | 0              | –12 | 9             | 10            | +20                | –250 |
| <b>50</b>  | <b>80</b>  |       | 0              | –15 | 11            | 10            | +20                | –300 |
| <b>80</b>  | <b>120</b> |       | 0              | –20 | 15            | 15            | +25                | –300 |
| <b>120</b> | <b>180</b> |       | 0              | –25 | 19            | 15            | +25                | –400 |

<sup>1)</sup> Also valid where raceway washers in the LS series are used

## Housing washer, GS 811

| D          | over       | incl. | $\Delta_{Dmp}$ |     | $V_{Dp}$      | $S_e$         |
|------------|------------|-------|----------------|-----|---------------|---------------|
|            |            |       | high           | low | max           |               |
| mm         |            |       | $\mu\text{m}$  |     | $\mu\text{m}$ | $\mu\text{m}$ |
| <b>18</b>  | <b>30</b>  |       | 0              | –13 | 10            | 10            |
| <b>30</b>  | <b>50</b>  |       | 0              | –16 | 12            | 10            |
| <b>50</b>  | <b>80</b>  |       | 0              | –19 | 14            | 10            |
| <b>80</b>  | <b>120</b> |       | 0              | –22 | 17            | 15            |
| <b>120</b> | <b>180</b> |       | 0              | –25 | 19            | 15            |
| <b>180</b> | <b>250</b> |       | 0              | –30 | 23            | 20            |

**Needle roller and cage thrust assemblies and appropriate washers**  
**d 4 – 80 mm**

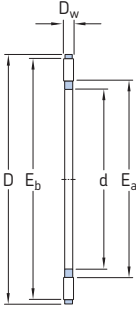

AXK

| Dimensions |     |                |                |                | Basic load ratings |                | Fatigue load limit | Speed ratings   |                | Mass | Designation        |
|------------|-----|----------------|----------------|----------------|--------------------|----------------|--------------------|-----------------|----------------|------|--------------------|
| d          | D   | D <sub>w</sub> | E <sub>a</sub> | E <sub>b</sub> | dynamic            | static         |                    | Reference speed | Limiting speed |      |                    |
| mm         |     |                |                |                | C                  | C <sub>0</sub> | P <sub>u</sub>     | r/min           | g              | -    |                    |
| 4          | 14  | 2              | 5              | 13             | 4,15               | 8,3            | 0,865              | 7 500           | 15 000         | 0,7  | <b>AXK 0414 TN</b> |
| 5          | 15  | 2              | 6              | 14             | 4,5                | 9,5            | 1                  | 6 700           | 14 000         | 0,8  | <b>AXK 0515 TN</b> |
| 6          | 19  | 2              | 7              | 18             | 6,3                | 16             | 1,75               | 6 000           | 12 000         | 1    | <b>AXK 0619 TN</b> |
| 8          | 21  | 2              | 9              | 20             | 7,2                | 20             | 2,2                | 5 600           | 11 000         | 2    | <b>AXK 0821 TN</b> |
| 10         | 24  | 2              | 12             | 23             | 8,5                | 26             | 2,85               | 5 300           | 10 000         | 3    | <b>AXK 1024</b>    |
| 12         | 26  | 2              | 14             | 25             | 9,15               | 30             | 3,25               | 5 000           | 10 000         | 3    | <b>AXK 1226</b>    |
| 15         | 28  | 2              | 17             | 27             | 10,4               | 37,5           | 4,15               | 4 800           | 9 500          | 4    | <b>AXK 1528</b>    |
| 17         | 30  | 2              | 19             | 29             | 11                 | 40,5           | 4,5                | 4 500           | 9 500          | 4    | <b>AXK 1730</b>    |
| 20         | 35  | 2              | 22             | 34             | 12                 | 47,5           | 5,3                | 4 300           | 8 500          | 5    | <b>AXK 2035</b>    |
| 25         | 42  | 2              | 29             | 41             | 13,4               | 60             | 6,7                | 3 800           | 7 500          | 7    | <b>AXK 2542</b>    |
| 30         | 47  | 2              | 34             | 46             | 15                 | 72             | 8                  | 3 600           | 7 000          | 8    | <b>AXK 3047</b>    |
| 35         | 52  | 2              | 39             | 51             | 16,6               | 83             | 9,3                | 3 200           | 6 300          | 10   | <b>AXK 3552</b>    |
| 40         | 60  | 3              | 45             | 58             | 25                 | 114            | 13,7               | 2 800           | 5 600          | 16   | <b>AXK 4060</b>    |
| 45         | 65  | 3              | 50             | 63             | 27                 | 127            | 15,3               | 2 600           | 5 300          | 18   | <b>AXK 4565</b>    |
| 50         | 70  | 3              | 55             | 68             | 28,5               | 143            | 17                 | 2 400           | 5 000          | 20   | <b>AXK 5070</b>    |
| 55         | 78  | 3              | 60             | 76             | 34,5               | 186            | 22,4               | 2 200           | 4 300          | 28   | <b>AXK 5578</b>    |
| 60         | 85  | 3              | 65             | 83             | 37,5               | 232            | 28,5               | 2 200           | 4 300          | 33   | <b>AXK 6085</b>    |
| 65         | 90  | 3              | 70             | 88             | 39                 | 255            | 31                 | 2 000           | 4 000          | 35   | <b>AXK 6590</b>    |
| 70         | 95  | 4              | 74             | 93             | 49                 | 255            | 30,5               | 1 800           | 3 600          | 60   | <b>AXK 7095</b>    |
| 75         | 100 | 4              | 79             | 98             | 50                 | 265            | 32                 | 1 700           | 3 400          | 61   | <b>AXK 75100</b>   |
| 80         | 105 | 4              | 84             | 103            | 51                 | 280            | 33,5               | 1 700           | 3 400          | 63   | <b>AXK 80105</b>   |

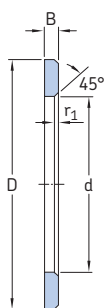

LS



AS

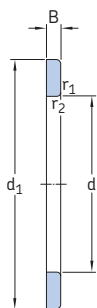

WS 811



GS 811

**Dimensions**  
Washers

d

d<sub>1</sub>

D

D<sub>1</sub>

B

r<sub>1,2</sub>  
min
**Masses**  
Washers  
LS,  
WS,  
GS

AS

**Designations**  
Raceway  
washer
Thrust  
washerShaft  
washerHousing  
washer

mm

g

-

|    |     |     |    |      |     |     |    |          |          |          |          |
|----|-----|-----|----|------|-----|-----|----|----------|----------|----------|----------|
| 4  | -   | 14  | -  | -    | -   | -   | 1  | -        | AS 0414  | -        | -        |
| 5  | -   | 15  | -  | -    | -   | -   | 1  | -        | AS 0515  | -        | -        |
| 6  | -   | 19  | -  | 2,75 | 0,3 | 6   | 2  | LS 0619  | AS 0619  | -        | -        |
| 8  | -   | 21  | -  | 2,75 | 0,3 | 6   | 2  | LS 0821  | AS 0821  | -        | -        |
| 10 | -   | 24  | -  | 2,75 | 0,3 | 8   | 3  | LS 1024  | AS 1024  | -        | -        |
| 12 | -   | 26  | -  | 2,75 | 0,3 | 9   | 3  | LS 1226  | AS 1226  | -        | -        |
| 15 | 28  | 28  | 16 | 2,75 | 0,3 | 9   | 3  | LS 1528  | AS 1528  | WS 81102 | GS 81102 |
| 17 | 30  | 30  | 18 | 2,75 | 0,3 | 10  | 4  | LS 1730  | AS 1730  | WS 81103 | GS 81103 |
| 20 | 35  | 35  | 21 | 2,75 | 0,3 | 14  | 5  | LS 2035  | AS 2035  | WS 81104 | GS 81104 |
| 25 | 42  | 42  | 26 | 3,00 | 0,6 | 21  | 7  | LS 2542  | AS 2542  | WS 81105 | GS 81105 |
| 30 | 47  | 47  | 32 | 3,00 | 0,6 | 24  | 8  | LS 3047  | AS 3047  | WS 81106 | GS 81106 |
| 35 | 52  | 52  | 37 | 3,50 | 0,6 | 32  | 9  | LS 3552  | AS 3552  | WS 81107 | GS 81107 |
| 40 | 60  | 60  | 42 | 3,50 | 0,6 | 43  | 12 | LS 4060  | AS 4060  | WS 81108 | GS 81108 |
| 45 | 65  | 65  | 47 | 4,00 | 0,6 | 54  | 13 | LS 4565  | AS 4565  | WS 81109 | GS 81109 |
| 50 | 70  | 70  | 52 | 4,00 | 0,6 | 59  | 14 | LS 5070  | AS 5070  | WS 81110 | GS 81110 |
| 55 | 78  | 78  | 57 | 5,00 | 0,6 | 94  | 18 | LS 5578  | AS 5578  | WS 81111 | GS 81111 |
| 60 | 85  | 85  | 62 | 4,75 | 1   | 110 | 22 | LS 6085  | AS 6085  | WS 81112 | GS 81112 |
| 65 | 90  | 90  | 67 | 5,25 | 1   | 120 | 24 | LS 6590  | AS 6590  | WS 81113 | GS 81113 |
| 70 | 95  | 95  | 72 | 5,25 | 1   | 130 | 25 | LS 7095  | AS 7095  | WS 81114 | GS 81114 |
| 75 | 100 | 100 | 77 | 5,75 | 1   | 150 | 27 | LS 75100 | AS 75100 | WS 81115 | GS 81115 |
| 80 | 105 | 105 | 82 | 5,75 | 1   | 160 | 28 | LS 80105 | AS 80105 | WS 81116 | GS 81116 |

Needle roller and cage thrust assemblies and appropriate washers  
d 85 – 160 mm

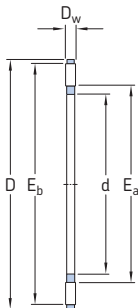

AXK

| Dimensions |     |                |                |                | Basic load ratings |                | Fatigue load limit | Speed ratings   |                | Mass | Designation       |
|------------|-----|----------------|----------------|----------------|--------------------|----------------|--------------------|-----------------|----------------|------|-------------------|
| d          | D   | D <sub>w</sub> | E <sub>a</sub> | E <sub>b</sub> | dynamic            | static         |                    | Reference speed | Limiting speed |      |                   |
| mm         |     |                |                |                | C                  | C <sub>0</sub> | P <sub>u</sub>     |                 |                | g    | –                 |
|            |     |                |                |                | kN                 |                | kN                 | r/min           |                |      |                   |
| <b>85</b>  | 110 | 4              | 89             | 108            | 52                 | 290            | 34,5               | 1 700           | 3 400          | 67   | <b>AXK 85110</b>  |
| <b>90</b>  | 120 | 4              | 94             | 118            | 65,5               | 405            | 48                 | 1 500           | 3 000          | 86   | <b>AXK 90120</b>  |
| <b>100</b> | 135 | 4              | 105            | 133            | 76,5               | 560            | 65,5               | 1 400           | 2 800          | 100  | <b>AXK 100135</b> |
| <b>110</b> | 145 | 4              | 115            | 143            | 81,5               | 620            | 71                 | 1 400           | 2 800          | 120  | <b>AXK 110145</b> |
| <b>120</b> | 155 | 4              | 125            | 153            | 86,5               | 680            | 76,5               | 1 300           | 2 600          | 130  | <b>AXK 120155</b> |
| <b>130</b> | 170 | 5              | 136            | 167            | 112                | 830            | 93                 | 1 100           | 2 200          | 210  | <b>AXK 130170</b> |
| <b>140</b> | 180 | 5              | 146            | 177            | 116                | 900            | 98,6               | 1 000           | 2 000          | 220  | <b>AXK 140180</b> |
| <b>150</b> | 190 | 5              | 156            | 187            | 120                | 950            | 102                | 1 000           | 2 000          | 230  | <b>AXK 150190</b> |
| <b>160</b> | 200 | 5              | 166            | 197            | 125                | 1000           | 106                | 950             | 1 900          | 250  | <b>AXK 160200</b> |

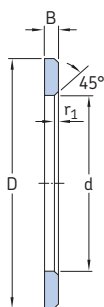

LS

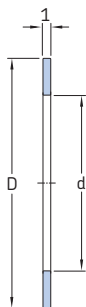

AS

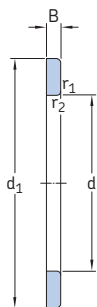

WS 811



GS 811

**Dimensions**  
Washers

d  
mm

d<sub>1</sub>

D

D<sub>1</sub>

B

r<sub>1,2</sub>  
min

**Masses**  
Washers  
LS, AS  
WS, GS

g

**Designations**  
Raceway  
washer

Thrust  
washer

Shaft  
washer

Housing  
washer

-

| Dimensions | Dimensions     | Dimensions | Dimensions     | Dimensions | Masses                  | Masses | Designations      | Designations     | Designations    | Designations      |
|------------|----------------|------------|----------------|------------|-------------------------|--------|-------------------|------------------|-----------------|-------------------|
| d          | d <sub>1</sub> | D          | D <sub>1</sub> | B          | r <sub>1,2</sub><br>min | LS, AS | Raceway<br>washer | Thrust<br>washer | Shaft<br>washer | Housing<br>washer |
| mm         |                |            |                |            |                         | g      | -                 |                  |                 |                   |
| 85         | 110            | 110        | 87             | 5,75       | 1                       | 170 29 | LS 85110          | AS 85110         | WS 81117        | GS 81117          |
| 90         | 120            | 120        | 92             | 6,50       | 1                       | 250 39 | LS 90120          | AS 90120         | WS 81118        | GS 81118          |
| 100        | 135            | 135        | 102            | 7,00       | 1                       | 350 50 | LS 100135         | AS 100135        | WS 81120        | GS 81120          |
| 110        | 145            | 145        | 112            | 7,00       | 1                       | 380 55 | LS 110145         | AS 110145        | WS 81122        | GS 81122          |
| 120        | 155            | 155        | 122            | 7,00       | 1                       | 410 59 | LS 120155         | AS 120155        | WS 81124        | GS 81124          |
| 130        | 170            | 170        | 132            | 9,00       | 1                       | 660 65 | LS 130170         | AS 130170        | WS 81126        | GS 81126          |
| 140        | 178            | 180        | 142            | 9,50       | 1                       | 700 79 | LS 140180         | AS 140180        | WS 81128        | GS 81128          |
| 150        | 188            | 190        | 152            | 9,50       | 1                       | 750 84 | LS 150190         | AS 150190        | WS 81130        | GS 81130          |
| 160        | 198            | 200        | 162            | 9,50       | 1                       | 790 89 | LS 160200         | AS 160200        | WS 81132        | GS 81132          |

**Needle roller thrust bearings with a centring spigot and appropriate washers**  
**d 10 – 50 mm**

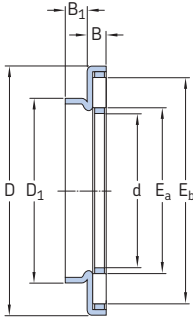

AXW

| Dimensions |    |                |     |                |                |                |         | Basic load ratings |                 | Fatigue load limit<br>$P_u$ | Speed ratings  |     | Mass          | Designation |
|------------|----|----------------|-----|----------------|----------------|----------------|---------|--------------------|-----------------|-----------------------------|----------------|-----|---------------|-------------|
| d          | D  | D <sub>1</sub> | B   | B <sub>1</sub> | E <sub>a</sub> | E <sub>b</sub> | dynamic | static             | Reference speed |                             | Limiting speed |     |               |             |
| mm         |    |                |     |                |                |                |         | kN                 |                 | kN                          | r/min          |     | g             | –           |
| <b>10</b>  | 27 | 14             | 3,2 | 3              | 12             | 23             | 8,5     | 26                 | 2,85            | 5 300                       | 10 000         | 8,3 | <b>AXW 10</b> |             |
| <b>12</b>  | 29 | 16             | 3,2 | 3              | 14             | 25             | 9,15    | 30                 | 3,25            | 5 000                       | 10 000         | 9,1 | <b>AXW 12</b> |             |
| <b>15</b>  | 31 | 21             | 3,2 | 3,5            | 17             | 27             | 10,4    | 37,5               | 4,15            | 4 800                       | 9 500          | 10  | <b>AXW 15</b> |             |
| <b>17</b>  | 33 | 23             | 3,2 | 3,5            | 19             | 29             | 11      | 40,5               | 4,5             | 4 500                       | 9 500          | 11  | <b>AXW 17</b> |             |
| <b>20</b>  | 38 | 26             | 3,2 | 3,5            | 22             | 34             | 12      | 47,5               | 5,3             | 4 300                       | 8 500          | 14  | <b>AXW 20</b> |             |
| <b>25</b>  | 45 | 32             | 3,2 | 4              | 29             | 41             | 13,4    | 60                 | 6,7             | 3 800                       | 7 500          | 20  | <b>AXW 25</b> |             |
| <b>30</b>  | 50 | 37             | 3,2 | 4              | 34             | 46             | 15      | 72                 | 8               | 3 600                       | 7 000          | 22  | <b>AXW 30</b> |             |
| <b>35</b>  | 55 | 42             | 3,2 | 4              | 39             | 51             | 16,6    | 83                 | 9,3             | 3 200                       | 6 300          | 27  | <b>AXW 35</b> |             |
| <b>40</b>  | 63 | 47             | 4,2 | 4              | 45             | 58             | 25      | 114                | 13,7            | 2 800                       | 5 600          | 39  | <b>AXW 40</b> |             |
| <b>45</b>  | 68 | 52             | 4,2 | 4              | 50             | 63             | 27      | 127                | 15,3            | 2 600                       | 5 300          | 43  | <b>AXW 45</b> |             |
| <b>50</b>  | 73 | 58             | 4,2 | 4,5            | 55             | 68             | 28,5    | 143                | 17              | 2 400                       | 5 000          | 49  | <b>AXW 50</b> |             |



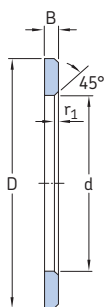

LS



AS

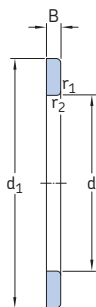

WS 811

**Dimensions**  
Washers

**Masses**  
Washers  
LS, WS AS

**Designations**  
Raceway washer

Thrust washer

Shaft washer

d d<sub>1</sub>, D B r<sub>1,2</sub>  
min

mm

g

–

|    |    |      |     |    |    |         |         |          |
|----|----|------|-----|----|----|---------|---------|----------|
| 10 | 24 | 2,75 | 0,3 | 8  | 3  | LS 1024 | AS 1024 | –        |
| 12 | 26 | 2,75 | 0,3 | 9  | 3  | LS 1226 | AS 1226 | –        |
| 15 | 28 | 2,75 | 0,3 | 9  | 3  | LS 1528 | AS 1528 | WS 81102 |
| 17 | 30 | 2,75 | 0,3 | 10 | 4  | LS 1730 | AS 1730 | WS 81103 |
| 20 | 35 | 2,75 | 0,3 | 14 | 5  | LS 2035 | AS 2035 | WS 81104 |
| 25 | 42 | 3,00 | 0,6 | 21 | 7  | LS 2542 | AS 2542 | WS 81105 |
| 30 | 47 | 3,00 | 0,6 | 24 | 8  | LS 3047 | AS 3047 | WS 81106 |
| 35 | 52 | 3,50 | 0,6 | 32 | 9  | LS 3552 | AS 3552 | WS 81107 |
| 40 | 60 | 3,50 | 0,6 | 43 | 12 | LS 4060 | AS 4060 | WS 81108 |
| 45 | 65 | 4,00 | 0,6 | 54 | 13 | LS 4565 | AS 4565 | WS 81109 |
| 50 | 70 | 4,00 | 0,6 | 59 | 14 | LS 5070 | AS 5070 | WS 81110 |



# Combined needle roller bearings

|                                                                               |            |
|-------------------------------------------------------------------------------|------------|
| <b>Needle roller / angular contact ball bearings</b> .....                    | <b>170</b> |
| Needle roller / angular contact ball bearings, NKIA series .....              | 170        |
| Needle roller / angular contact ball bearings, NKIB series.....               | 170        |
| Dimensions.....                                                               | 171        |
| Tolerances.....                                                               | 171        |
| Internal clearance.....                                                       | 171        |
| Misalignment.....                                                             | 171        |
| Cages.....                                                                    | 172        |
| Shaft and housing tolerances .....                                            | 172        |
| Lubrication.....                                                              | 173        |
| Product tables.....                                                           | 174        |
| 7.1 Needle roller / angular contact ball bearings .....                       | 174        |
| <b>Needle roller / thrust ball bearings</b> .....                             | <b>178</b> |
| Needle roller / thrust ball bearings, NX series .....                         | 179        |
| Needle roller / thrust ball bearings, NKX series .....                        | 180        |
| Dimensions.....                                                               | 180        |
| Tolerances.....                                                               | 180        |
| Shaft and housing tolerances .....                                            | 180        |
| Internal clearance.....                                                       | 181        |
| Misalignment.....                                                             | 181        |
| Cages.....                                                                    | 182        |
| Lubrication.....                                                              | 182        |
| Design of associated components .....                                         | 183        |
| Application recommendations.....                                              | 183        |
| Supplementary designations.....                                               | 183        |
| Product tables.....                                                           | 184        |
| 7.2 Needle roller / thrust ball bearings, full complement thrust bearing..... | 184        |
| 7.3 Needle roller / thrust ball bearings, thrust bearing with a cage.....     | 186        |
| <b>Needle roller / cylindrical roller thrust bearings</b> .....               | <b>188</b> |
| Needle roller / cylindrical roller thrust bearings, NKXR series .....         | 188        |
| Needle roller / cylindrical roller thrust bearings, NKXR .. Z series.....     | 188        |
| Dimensions.....                                                               | 189        |
| Tolerances.....                                                               | 189        |
| Shaft and housing tolerances .....                                            | 189        |
| Internal clearance.....                                                       | 189        |
| Misalignment.....                                                             | 190        |
| Cages.....                                                                    | 190        |
| Lubrication.....                                                              | 190        |
| Design of associated components .....                                         | 191        |
| Application recommendations.....                                              | 191        |
| Supplementary designations.....                                               | 191        |
| Product tables.....                                                           | 192        |
| 7.4 Needle roller / cylindrical roller thrust bearings.....                   | 192        |

## Needle roller / angular contact ball bearings

Combined needle roller bearings consist of a radial needle roller bearing combined with a thrust bearing and are consequently able to accommodate both radial and axial loads. Combined needle roller bearings provide the means to produce locating bearing arrangements where radial space is limited. They are particularly suitable for applications where other types of locating bearings occupy too much space, or where the axial loads are too heavy, the speeds are too high, or the lubricant is inadequate for simple thrust washers. SKF supplies combined needle roller bearings in the following designs:

- needle roller / angular contact ball bearings
- needle roller / thrust ball bearings
- needle roller / cylindrical roller thrust bearings

## Needle roller / angular contact ball bearings

Needle roller / angular contact ball bearings combine a radial needle roller bearing with a radial angular contact ball bearing to produce a low cross section bearing that can operate at high speeds and accommodate heavy radial and light axial loads. The radial loads are accommodated exclusively by the needle roller bearing. SKF supplies these bearings in the following two series:

- NKIA series (→ **fig. 1**), accommodates axial loads in one direction
- NKIB series (→ **fig. 2**), accommodates axial loads in both directions

### Note

Bearings of both series are separable. In other words, the inner ring can be mounted separately from the outer ring, roller and cage assemblies. However, the bearings must be kept together as supplied – e.g. the outer ring, roller and cage assembly from one bearing are not interchangeable with the the roller and cage assembly from another seemingly identical bearing.

### Needle roller / angular contact ball bearings, NKIA series

SKF needle roller / angular contact ball bearings in the NKIA 59 series (→ **fig. 1**) can accommodate axial loads acting in one direction and can therefore locate the shaft in one direction.

For short shafts, where changes in length as a result of thermal expansion are relatively minor, two bearings in the NKIA 59 series can be used in a back-to-back (mirrored) arrangement (→ **fig. 3**).

### Needle roller / angular contact ball bearings, NKIB series

Needle roller / angular contact ball bearings in the NKIB 59 series (→ **fig. 2**) are able to locate

Fig. 1

Needle roller / angular contact ball bearing

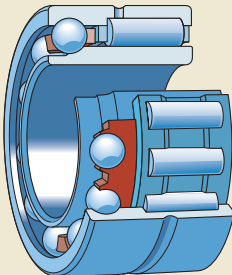

NKIA 59 series

Fig. 2

Needle roller / angular contact ball bearing

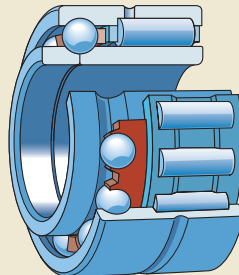

NKIB 59 series

a shaft in both directions with an axial play between 0,08 and 0,25 mm. To facilitate mounting, the bearing has a two-piece inner ring. When mounting the inner ring, it is important that the two pieces are mounted immediately adjacent to each other without any gap between them.

## Dimensions

The boundary dimensions of bearings in the NKIA 59 series are in accordance with Dimension Series 59 of ISO 15:1998.

With the exception of the inner ring width, which is extended on one side, the boundary dimensions of bearings in the NKIB 59 series are in accordance with Dimension Series 59 of ISO 15:1998.

## Tolerances

SKF supplies needle roller / angular contact ball bearings to Normal tolerances in accordance with ISO 492:2002 as standard.

The following tolerances in the NKIB 59 series are exceptions:

- The bore diameter of the narrow part of the inner ring is slightly larger.
- The width tolerances of the complete inner ring is 0/-0,3 mm for all sizes.

## Internal clearance

SKF supplies needle roller / angular contact ball bearings with Normal radial internal clearance as standard.

The values for radial internal clearance are listed in **table 7** on **page 42** and are in accordance with ISO 5753-1:2009. They are valid for unmounted bearings under zero measuring load.

## Misalignment

SKF needle rollers are relieved slightly toward their ends. The modified line contact achieved between the raceways and the needle rollers provides favourable load distribution in the bearing and minimizes damaging edge stresses. It also enables needle roller / angular contact ball bearings to accommodate a minimum amount of misalignment. The detrimental effect of misalignment increases with increasing bearing width and load. Needle roller / angular contact ball bearings are sensitive to misalignment. If misalignment can not be avoided, contact the SKF application engineering service.

Fig. 3

NKIA 59 series, back-to-back arrangement

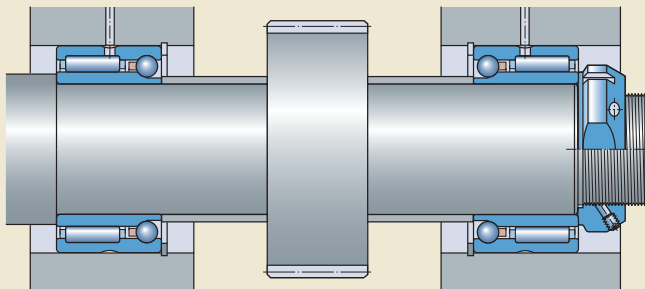

## Needle roller / angular contact ball bearings

### Cages

The radial needle roller bearing is fitted as standard with a machined steel cage (→ **fig. 4**) or a sheet steel cage (→ **fig. 5**). The balls of the angular contact ball bearing are retained in an injection moulded cage made of glass fibre reinforced polyamide 66 (→ **fig. 6**).

### Note

Limited by the polyamide 66 cage, needle roller / angular contact ball bearings should not be operated at temperatures above 120 °C.

The lubricants generally used for rolling bearings do not have a detrimental effect on cage properties. Exceptions are a few synthetic oils and greases with a synthetic oil base and lubricants containing a high proportion of EP additives when used at high temperatures.

For detailed information about the temperature resistance and the applicability of cages, refer to the section *Cage materials*, starting on **page 44**.

### Shaft and housing tolerances

For needle roller / angular contact ball bearings SKF recommends machining the shaft seat to a k5 tolerance class, and the housing bore seat to an M6 tolerance class.

Tighter fits than those achieved with these tolerance classes should be avoided as they could have a negative influence on bearing performance.

In addition to their interference fit on the shaft and in the housing, the bearing rings should be located axially by a shaft shoulder or snap ring.

Fig. 4

Machined steel cage of the radial bearing

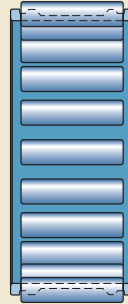

Fig. 5

Sheet steel cage of the radial bearing



Fig. 6

Polyamide 66 cage of the angular contact ball bearing



## Lubrication

To facilitate efficient lubrication, the needle roller bearing has an annular groove with one lubrication hole in the outer ring. Depending on the application, needle roller / angular contact ball bearings can be grease or oil lubricated. In the case of grease lubrication, both the needle roller bearing and ball bearing should be filled with the same lubricant. If grease lubrication is going to be used, the bearing should be lubricated before mounting.

Relubrication intervals for the needle roller and angular contact ball bearing must be calculated separately. The lower of the two intervals should be used.

For additional information about lubrication, refer to the section *Lubrication*, starting on **page 52**.

Needle roller / angular contact ball bearings  
d 12 – 60 mm

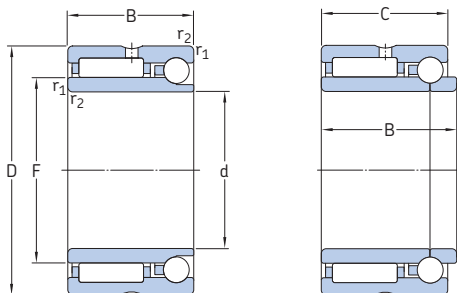

NKIA

NKIB

| Principal dimensions |    |      |    | Basic load ratings |                       |                 |                       | Fatigue load limits   |                      | Speed ratings   |                | Mass  | Designation |
|----------------------|----|------|----|--------------------|-----------------------|-----------------|-----------------------|-----------------------|----------------------|-----------------|----------------|-------|-------------|
| d                    | D  | B    | C  | radial dynamic C   | static C <sub>0</sub> | axial dynamic C | static C <sub>0</sub> | radial P <sub>u</sub> | axial P <sub>u</sub> | Reference speed | Limiting speed | kg    | –           |
| mm                   |    |      |    | kN                 |                       |                 |                       | kN                    |                      | r/min           |                | kg    | –           |
| 12                   | 24 | 16   | –  | 8,25               | 10                    | 2,07            | 1,92                  | 1,14                  | 0,083                | 22 000          | 26 000         | 0,04  | NKIA 5901   |
|                      | 24 | 17,5 | 16 | 8,25               | 10                    | 2,07            | 1,92                  | 1,14                  | 0,083                | 22 000          | 26 000         | 0,043 | NKIB 5901   |
| 15                   | 28 | 18   | –  | 11,4               | 15,6                  | 2,27            | 2,37                  | 1,83                  | 0,099                | 19 000          | 22 000         | 0,05  | NKIA 5902   |
|                      | 28 | 20   | 18 | 11,4               | 15,6                  | 2,27            | 2,37                  | 1,83                  | 0,099                | 19 000          | 22 000         | 0,052 | NKIB 5902   |
| 17                   | 30 | 18   | –  | 11,7               | 17                    | 2,24            | 2,74                  | 1,96                  | 0,116                | 18 000          | 20 000         | 0,056 | NKIA 5903   |
|                      | 30 | 20   | 18 | 11,7               | 17                    | 2,24            | 2,74                  | 1,96                  | 0,116                | 18 000          | 20 000         | 0,058 | NKIB 5903   |
| 20                   | 37 | 23   | –  | 21,6               | 28                    | 3,79            | 4,21                  | 3,35                  | 0,176                | 15 000          | 17 000         | 0,1   | NKIA 5904   |
|                      | 37 | 25   | 23 | 21,6               | 28                    | 3,79            | 4,21                  | 3,35                  | 0,176                | 15 000          | 17 000         | 0,11  | NKIB 5904   |
| 22                   | 39 | 23   | –  | 23,3               | 32                    | 4,14            | 4,93                  | 3,9                   | 0,205                | 14 000          | 15 000         | 0,12  | NKIA 59/22  |
|                      | 39 | 25   | 23 | 23,3               | 32                    | 4,14            | 4,93                  | 3,9                   | 0,205                | 14 000          | 15 000         | 0,12  | NKIB 59/22  |
| 25                   | 42 | 23   | –  | 24,2               | 34,5                  | 4,24            | 5,26                  | 4,15                  | 0,224                | 13 000          | 15 000         | 0,13  | NKIA 5905   |
|                      | 42 | 25   | 23 | 24,2               | 34,5                  | 4,24            | 5,26                  | 4,15                  | 0,224                | 13 000          | 15 000         | 0,13  | NKIB 5905   |
| 30                   | 47 | 23   | –  | 25,5               | 39                    | 4,54            | 6,32                  | 4,65                  | 0,268                | 11 000          | 13 000         | 0,15  | NKIA 5906   |
|                      | 47 | 25   | 23 | 25,5               | 39                    | 4,54            | 6,32                  | 4,65                  | 0,268                | 11 000          | 13 000         | 0,15  | NKIB 5906   |
| 35                   | 55 | 27   | –  | 31,9               | 54                    | 5,83            | 8,42                  | 6,7                   | 0,355                | 9 500           | 11 000         | 0,24  | NKIA 5907   |
|                      | 55 | 30   | 27 | 31,9               | 54                    | 5,83            | 8,42                  | 6,7                   | 0,355                | 9 500           | 11 000         | 0,25  | NKIB 5907   |
| 40                   | 62 | 30   | –  | 42,9               | 71                    | 7,17            | 10,9                  | 8,8                   | 0,467                | 8 000           | 9 500          | 0,32  | NKIA 5908   |
|                      | 62 | 34   | 30 | 42,9               | 71                    | 7,17            | 10,9                  | 8,8                   | 0,467                | 8 000           | 9 500          | 0,32  | NKIB 5908   |
| 45                   | 68 | 30   | –  | 45,7               | 78                    | 7,47            | 12                    | 9,65                  | 0,513                | 7 500           | 8 500          | 0,38  | NKIA 5909   |
|                      | 68 | 34   | 30 | 45,7               | 78                    | 7,47            | 12                    | 9,65                  | 0,513                | 7 500           | 8 500          | 0,38  | NKIB 5909   |
| 50                   | 72 | 30   | –  | 47,3               | 85                    | 7,74            | 13,7                  | 10,6                  | 0,579                | 7 000           | 8 000          | 0,38  | NKIA 5910   |
|                      | 72 | 34   | 30 | 47,3               | 85                    | 7,74            | 13,7                  | 10,6                  | 0,579                | 7 000           | 8 000          | 0,39  | NKIB 5910   |
| 55                   | 80 | 34   | –  | 57,2               | 104                   | 9,27            | 16,7                  | 13,2                  | 0,697                | 6 300           | 7 000          | 0,55  | NKIA 5911   |
|                      | 80 | 38   | 34 | 57,2               | 104                   | 9,27            | 16,7                  | 13,2                  | 0,697                | 6 300           | 7 000          | 0,56  | NKIB 5911   |
| 60                   | 85 | 34   | –  | 59,4               | 114                   | 9,58            | 18                    | 14,3                  | 0,77                 | 6 000           | 6 700          | 0,59  | NKIA 5912   |
|                      | 85 | 38   | 34 | 59,4               | 114                   | 9,58            | 18                    | 14,3                  | 0,77                 | 6 000           | 6 700          | 0,6   | NKIB 5912   |



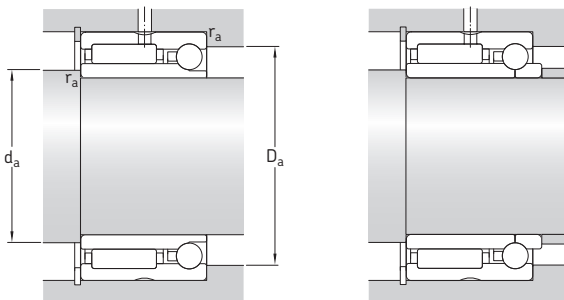

### Dimensions

### Abutment and fillet dimensions

| d  | F  | $r_{1,2}$<br>min | $d_a$<br>min | $D_a$<br>max | $r_a$<br>max |
|----|----|------------------|--------------|--------------|--------------|
| mm |    |                  | mm           |              |              |
| 12 | 16 | 0,3              | 14           | 22           | 0,3          |
|    | 16 | 0,3              | 14           | 22           | 0,3          |
| 15 | 20 | 0,3              | 17           | 26           | 0,3          |
|    | 20 | 0,3              | 17           | 26           | 0,3          |
| 17 | 22 | 0,3              | 19           | 28           | 0,3          |
|    | 22 | 0,3              | 19           | 28           | 0,3          |
| 20 | 25 | 0,3              | 22           | 35           | 0,3          |
|    | 25 | 0,3              | 22           | 35           | 0,3          |
| 22 | 28 | 0,3              | 24           | 37           | 0,3          |
|    | 28 | 0,3              | 24           | 37           | 0,3          |
| 25 | 30 | 0,3              | 27           | 40           | 0,3          |
|    | 30 | 0,3              | 27           | 40           | 0,3          |
| 30 | 35 | 0,3              | 32           | 45           | 0,3          |
|    | 35 | 0,3              | 32           | 45           | 0,3          |
| 35 | 42 | 0,6              | 39           | 51           | 0,6          |
|    | 42 | 0,6              | 39           | 51           | 0,6          |
| 40 | 48 | 0,6              | 44           | 58           | 0,6          |
|    | 48 | 0,6              | 44           | 58           | 0,6          |
| 45 | 52 | 0,6              | 49           | 64           | 0,6          |
|    | 52 | 0,6              | 49           | 64           | 0,6          |
| 50 | 58 | 0,6              | 54           | 68           | 0,6          |
|    | 58 | 0,6              | 54           | 68           | 0,6          |
| 55 | 63 | 1                | 60           | 75           | 1            |
|    | 63 | 1                | 60           | 75           | 1            |
| 60 | 68 | 1                | 65           | 80           | 1            |
|    | 68 | 1                | 65           | 80           | 1            |

Needle roller / angular contact ball bearings  
d 65 – 70 mm

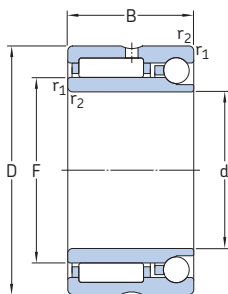

NKIA

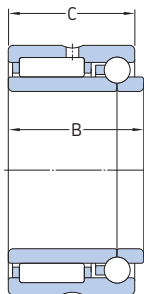

NKIB

| Principal dimensions |     |    |    | Basic load ratings |                       |                 |                       | Fatigue load limits   |                      | Speed ratings   |                | Mass | Designation |
|----------------------|-----|----|----|--------------------|-----------------------|-----------------|-----------------------|-----------------------|----------------------|-----------------|----------------|------|-------------|
| d                    | D   | B  | C  | radial dynamic C   | static C <sub>0</sub> | axial dynamic C | static C <sub>0</sub> | radial P <sub>u</sub> | axial P <sub>u</sub> | Reference speed | Limiting speed | kg   |             |
| mm                   |     |    |    | kN                 |                       |                 |                       | kN                    |                      | r/min           |                | kg   | –           |
| 65                   | 90  | 34 | –  | 60,5               | 118                   | 9,96            | 19,2                  | 14,6                  | 0,816                | 5 600           | 6 300          | 0,64 | NKIA 5913   |
|                      | 90  | 38 | 34 | 60,5               | 118                   | 9,96            | 19,2                  | 14,6                  | 0,816                | 5 600           | 6 300          | 0,64 | NKIB 5913   |
| 70                   | 100 | 40 | –  | 84,2               | 163                   | 13,2            | 25                    | 20,8                  | 1,05                 | 5 000           | 5 600          | 0,98 | NKIA 5914   |
|                      | 100 | 45 | 40 | 84,2               | 163                   | 13,2            | 25                    | 20,8                  | 1,05                 | 5 000           | 5 600          | 0,99 | NKIB 5914   |

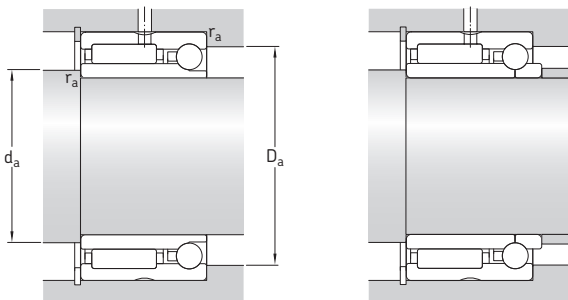

**Dimensions**

**Abutment and fillet dimensions**

| d         | F  | $r_{1,2}$<br>min | $d_a$<br>min | $D_a$<br>max | $r_a$<br>max |
|-----------|----|------------------|--------------|--------------|--------------|
| mm        |    |                  | mm           |              |              |
| <b>65</b> | 72 | 1                | 70           | 85           | 1            |
|           | 72 | 1                | 70           | 85           | 1            |
| <b>70</b> | 80 | 1                | 75           | 95           | 1            |
|           | 80 | 1                | 75           | 95           | 1            |

## Needle roller / thrust ball bearings

Needle roller / thrust ball bearings combine a radial needle roller bearing and a thrust ball bearing. SKF supplies these bearings in the following two series:

- NX series (→ **fig. 7**), a needle roller bearing with a full complement thrust ball bearing
- NKX series (→ **fig. 8**), a needle roller bearing with a thrust ball bearing with a cage

SKF supplies the bearings in both series without an inner ring. However, for applications where it is not possible to harden and grind the shaft, the needle roller bearing can be combined with an inner ring (→ **fig. 9**). Appropriate inner rings are listed in the product tables and can be ordered separately.

Fig. 7

Needle roller / thrust ball bearing

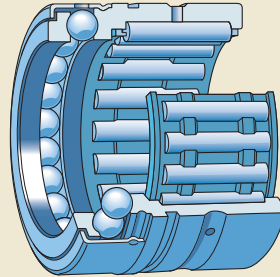

NX series

Fig. 8

Needle roller / thrust ball bearing

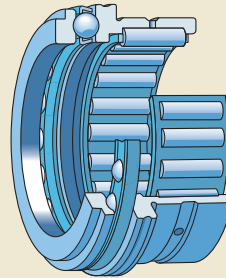

NKX series

Fig. 9

Needle roller / thrust ball bearing, combined with an inner ring

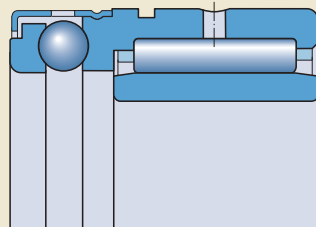

NX series

## Needle roller / thrust ball bearings, NX series

SKF needle roller / full complement thrust ball bearings in the NX series are suitable for applications where there are moderate radial loads and lighter, single direction axial loads. Their extremely low sectional height enables shaft centrelines to be positioned close together as is the case for multi-spindle drilling machines.

For axial support, the bearings may be mounted against a shoulder or snap ring in the housing bore. The snap ring groove in the outer ring provides a cost-effective and axially space-saving arrangement (→ **fig. 10**). The appropriate snap rings are listed in the product tables.

Needle roller / thrust ball bearings in the NX series have a stamped steel cover that extends over the shaft washer of the thrust ball bearing and is firmly attached to the radial needle roller bearing. These bearings are therefore non-separable. Bearings in the NX series have lubrication holes in the cover (→ **fig. 11**) and are intended for oil lubrication.

Bearings in the NX .. Z series (→ **fig. 12**) should be grease lubricated. SKF supplies the thrust ball bearing in this series filled, as standard, with a high-quality grease with good rust-inhibiting properties. The cover, which has no lubrication holes, forms a gap-type seal with the shaft washer to retain the grease in the bearing.

Fig. 10

NX series mounted with a snap ring

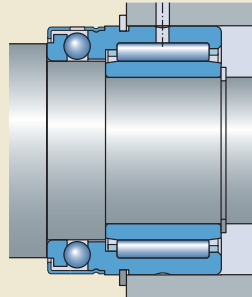
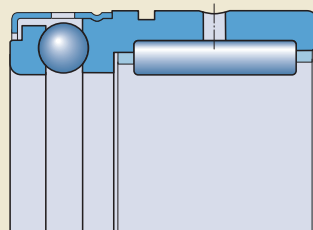

Fig. 11

Needle roller / thrust ball bearing, with lubrication holes in the cover



NX series

Fig. 12

Needle roller / thrust ball bearing, no lubrication holes in the cover

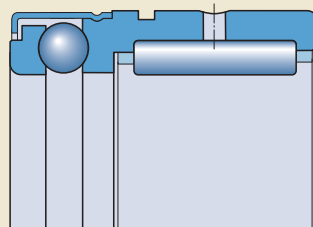

NX .. Z series

## Needle roller / thrust ball bearings

### Needle roller / thrust ball bearings, NKX series

SKF needle roller / thrust ball bearings in the NKX series combine a radial needle roller bearing and a thrust ball bearing based on the 511 series. They are able to support single-direction axial loads in addition to radial loads. They also permit relatively high-speed operation.

NKX series needle roller / thrust ball bearings (→ **fig. 13**) do not have a cover around the thrust ball bearing. As a result, both the ball and cage assembly and shaft washer can be mounted separately from the rest of the bearing.

NKX .. Z series needle roller / thrust ball bearings (→ **fig. 14**) are non-separable. They have a stamped steel cover that extends over the shaft washer of the thrust ball bearing. It is firmly attached to the housing washer that is integral to the needle roller bearing outer ring. The cover makes these bearings non-separable. SKF supplies the thrust ball bearing in this series filled, as standard, with a high-quality grease that has good rust inhibiting properties. The cover, which has no lubrication holes, forms a gap-type seal with the shaft washer to retain the grease in the bearing.

### Dimensions

The boundary dimensions of needle roller / thrust ball bearings in the NKX and NKX .. Z series are in accordance with DIN 5429-1:2005-08.

The dimensions of bearings in the NX and NX .. Z series are not standardized, but are common in the market.

### Tolerances

SKF needle roller / thrust ball bearings are manufactured to the tolerances and tolerance classes listed in **table 1**. The radial runout values are in accordance with ISO 492:2002 and the Normal axial runout values are in accordance with ISO 199:2005.

The values for the deviations from the nominal diameter of the ISO tolerance classes F6 and E8 in **table 1** are listed in **table 2**.

### Shaft and housing tolerances

SKF recommends machining the shaft seat to a k5 tolerance class for bearings with or without an inner ring.

For the housing bore seat, SKF recommends a K6 tolerance class. For stiff bearing arrangements, SKF recommends an M6 housing bore tolerance class.

In addition to their interference fit on the shaft and in the housing, the bearing rings must be axially located by a shoulder or snap ring.

Fig. 13

Needle roller / thrust ball bearing

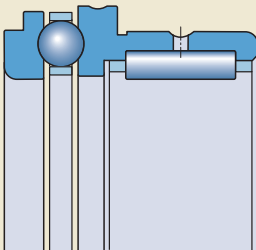

NKX series

Fig. 14

Needle roller / thrust ball bearing

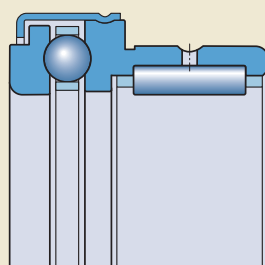

NKX .. Z series

## Internal clearance

SKF needle roller / thrust ball bearings combined with the appropriate inner ring, as listed in the product tables, have Normal radial internal clearance as standard. The clearance values are listed in **table 7** on **page 42** and are in accordance with ISO 5753-1:2009. They are valid for unmounted bearings under zero measuring load.

The radial internal clearance for SKF needle roller / thrust ball bearings without an inner ring depends on the shaft tolerance. If the recommended k5 shaft tolerance class is applied, the tolerance for the inside diameter  $F_w$  will provide an internal clearance that is slightly less than the Normal radial internal clearance.

## Misalignment

SKF needle roller / thrust ball bearings in the NX and NKX series cannot tolerate any angular misalignment between the shaft and the housing or any misalignment between the shaft and the axial support surfaces in the housing.

Table 1

### Needle roller / thrust ball bearing tolerances

| Dimension <sup>1)</sup>                     |       | Tolerance, tolerance class |
|---------------------------------------------|-------|----------------------------|
| Outside diameter                            | D     | Normal, ISO 492:1994       |
| Inside diameter of needle roller complement | $F_w$ | F6                         |
| Bore diameter                               | d     | E8                         |
| Width                                       | C     | 0/-0,25 mm                 |
| Width <sup>2)</sup>                         | $C_1$ | 0/-0,20 mm                 |

<sup>1)</sup> Refer to the illustrations in the product tables, starting on **page 184**.

<sup>2)</sup> Applicable to bearings in the NKX and NKX .. Z series only

Table 2

### ISO tolerance classes

| Nominal diameter | over incl. | E8              |     | F6              |     |
|------------------|------------|-----------------|-----|-----------------|-----|
|                  |            | Deviations high | low | Deviations high | low |
| mm               |            | $\mu\text{m}$   |     | $\mu\text{m}$   |     |
| 6                | 10         | +47             | +25 | +22             | +13 |
| 10               | 18         | +59             | +32 | +27             | +16 |
| 18               | 30         | +73             | +40 | +33             | +20 |
| 30               | 50         | +89             | +50 | +41             | +25 |
| 50               | 80         | +106            | +60 | +49             | +30 |

## Needle roller / thrust ball bearings

### Cages

The radial needle roller bearing is fitted as standard with a machined steel (→ **fig. 4, page 172**) or a sheet steel cage (→ **fig. 5, page 172**), no designation suffix. However, some small bearings are fitted as standard with an injection moulded cage of glass fibre reinforced polyamide 66 (→ **fig. 15**), designation suffix TN.

The cage, that retains the balls of the thrust ball bearing (NKX series), is made of sheet steel (→ **fig. 16**).

### Note

Needle roller / thrust ball bearings with a polyamide 66 cage should not be operated at temperatures above 120 °C.

The lubricants generally used for rolling bearings do not have a detrimental effect on cage properties. Exceptions are a few synthetic oils and greases with a synthetic oil base and lubricants containing a high proportion of EP additives when used at high temperatures.

For bearing arrangements that will operate at continuously high temperatures or under arduous conditions, SKF recommends using needle roller / thrust ball bearings with steel cages.

For detailed information about the temperature resistance and the applicability of cages, refer to the section *Cage materials*, starting on **page 44**.

### Lubrication

To facilitate efficient lubrication, the needle roller bearing has an annular groove with one lubrication hole in the outer ring.

The shielded thrust bearing of needle roller / thrust ball bearings with the designation suffix Z is filled at the factory with a high-quality grease that has good corrosion inhibiting properties. For relubrication, SKF recommends SKF LGWA 2 grease. For additional information about greases, refer to the section *Lubrication*, starting on **page 52**.

Bearings in the NKX and NX series without the designation suffix Z should be oil lubricated whenever possible, as oil facilitates an adequate supply of lubricant to the bearing.

Fig. 15

Polyamide 66 cage of the radial bearing

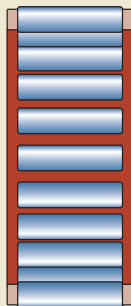

Fig. 16

Sheet steel cage of the thrust ball bearing, NKX series



Relubrication intervals for the axial and radial components must be calculated separately. The lower of the two intervals should be used. A calculation is needed for both oil and grease lubrication.



## Design of associated components

The diameter of the support surface for the integral housing washer of a needle roller / thrust ball bearing must always be at least 0,5 mm larger than the dimension  $D_1$  or  $D_2$  (→ fig. 17) to obtain a clearance fit. The values for the diameters  $D_1$  and  $D_2$  are listed in the product table.

## Application recommendations

SKF needle roller / thrust ball bearings can locate a shaft axially in one direction only. For short shafts, where changes in length as a result of thermal expansion are relatively minor, two bearings can be used in a back-to-back (mirrored) arrangement (→ fig. 18). In these cases SKF recommends elastically preloading the thrust ball bearings with cup springs (belleville washers). This elastic preload helps to avoid skidding of the balls when one of the thrust bearings is unloaded and facilitates proper and quiet performance of the thrust ball bearing.

## Supplementary designations

The designation suffixes used to identify certain features of SKF needle roller / thrust ball bearings are explained in the following.

- Z Thrust ball bearing with a cover over the outside diameter without lubrication holes. Filled at the factory with a high-quality lithium base NLGI 2 grease.

Fig. 17

Clearance fit for the integral housing washer

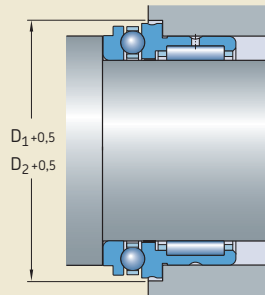
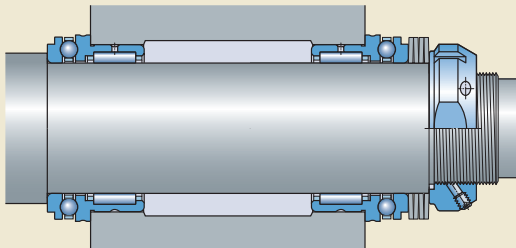

Fig. 18

NKX series, back-to-back arrangement, incorporating belleville washers



# Needle roller / thrust ball bearings, full complement thrust bearing

F<sub>w</sub> 7 – 35 mm

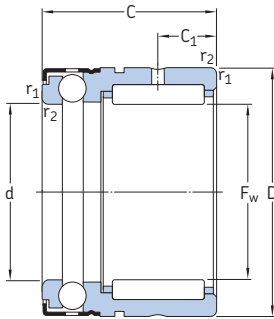

NX

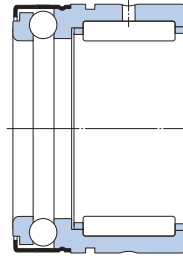

NX..Z

| Principal dimensions | Basic load ratings |    |      |          |                        |                       | Fatigue load limits   |                      | Min. load factor A | Speed ratings   |                | Mass  | Designation            |
|----------------------|--------------------|----|------|----------|------------------------|-----------------------|-----------------------|----------------------|--------------------|-----------------|----------------|-------|------------------------|
|                      | F <sub>w</sub>     | D  | C    | radial C | dynamic C <sub>0</sub> | static C <sub>0</sub> | radial P <sub>u</sub> | axial P <sub>u</sub> |                    | Reference speed | Limiting speed |       |                        |
| mm                   | kN                 |    |      |          |                        |                       | kN                    |                      | –                  | r/min           |                | kg    | –                      |
| 7                    | 14                 | 18 | 2,81 | 2,75     | 3,45                   | 5                     | 0,29                  | 0,186                | 0,13               | 10 000          | 11 000         | 0,014 | NX 7 TN <sup>1)</sup>  |
|                      | 14                 | 18 | 2,81 | 2,75     | 3,45                   | 5                     | 0,29                  | 0,186                | 0,13               | 10 000          | 6 000          | 0,014 | NX 7 ZTN <sup>1)</sup> |
| 10                   | 19                 | 18 | 4,68 | 4,15     | 5,07                   | 8,5                   | 0,475                 | 0,31                 | 0,38               | 8 500           | 9 500          | 0,025 | NX 10                  |
|                      | 19                 | 18 | 4,68 | 4,15     | 5,07                   | 8,5                   | 0,475                 | 0,31                 | 0,38               | 8 500           | 5 600          | 0,025 | NX 10 Z                |
| 12                   | 21                 | 18 | 5,5  | 5,4      | 5,27                   | 9,65                  | 0,61                  | 0,355                | 0,48               | 8 000           | 9 000          | 0,028 | NX 12                  |
|                      | 21                 | 18 | 5,5  | 5,4      | 5,27                   | 9,65                  | 0,61                  | 0,355                | 0,48               | 8 000           | 5 300          | 0,028 | NX 12 Z                |
| 15                   | 24                 | 28 | 11,2 | 14       | 6,18                   | 12,2                  | 1,66                  | 0,45                 | 0,77               | 7 500           | 8 500          | 0,048 | NX 15                  |
|                      | 24                 | 28 | 11,2 | 14       | 6,18                   | 12,2                  | 1,66                  | 0,45                 | 0,77               | 7 500           | 5 300          | 0,048 | NX 15 Z                |
| 17                   | 26                 | 28 | 12,3 | 16,6     | 6,37                   | 13,4                  | 1,96                  | 0,5                  | 0,93               | 7 000           | 8 500          | 0,053 | NX 17                  |
|                      | 26                 | 28 | 12,3 | 16,6     | 6,37                   | 13,4                  | 1,96                  | 0,5                  | 0,93               | 7 000           | 5 000          | 0,053 | NX 17 Z                |
| 20                   | 30                 | 28 | 13,4 | 19,6     | 7,8                    | 17,3                  | 2,28                  | 0,64                 | 1,6                | 6 300           | 7 500          | 0,068 | NX 20                  |
|                      | 30                 | 28 | 13,4 | 19,6     | 7,8                    | 17,3                  | 2,28                  | 0,64                 | 1,6                | 6 300           | 4 500          | 0,068 | NX 20 Z                |
| 25                   | 37                 | 30 | 15,4 | 25       | 12,4                   | 28,5                  | 2,9                   | 1,06                 | 4,2                | 5 600           | 6 300          | 0,12  | NX 25                  |
|                      | 37                 | 30 | 15,4 | 25       | 12,4                   | 28,5                  | 2,9                   | 1,06                 | 4,2                | 5 600           | 3 800          | 0,12  | NX 25 Z                |
| 30                   | 42                 | 30 | 22,9 | 39       | 12,7                   | 32,5                  | 4,8                   | 1,2                  | 5,5                | 5 300           | 6 000          | 0,13  | NX 30                  |
|                      | 42                 | 30 | 22,9 | 39       | 12,7                   | 32,5                  | 4,8                   | 1,2                  | 5,5                | 5 300           | 3 600          | 0,13  | NX 30 Z                |
| 35                   | 47                 | 30 | 24,6 | 45       | 13,5                   | 38                    | 5,6                   | 1,4                  | 7,5                | 5 000           | 5 600          | 0,16  | NX 35                  |
|                      | 47                 | 30 | 24,6 | 45       | 13,5                   | 38                    | 5,6                   | 1,4                  | 7,5                | 5 000           | 3 400          | 0,16  | NX 35 Z                |

<sup>1)</sup> Radial bearing with inserted closure ring

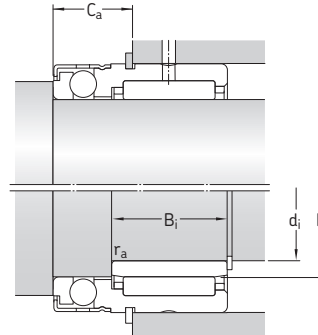
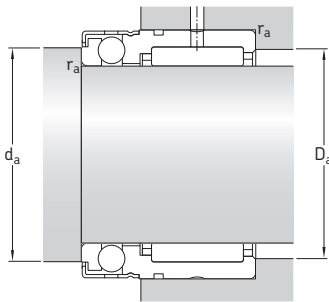

| Dimensions     |                |    |                      | Abutment and fillet dimensions |                    |                |                    | Appropriate inner ring <sup>2)</sup> Dimensions |    |                |                 | Appropriate snap ring <sup>3)</sup> Designation |
|----------------|----------------|----|----------------------|--------------------------------|--------------------|----------------|--------------------|-------------------------------------------------|----|----------------|-----------------|-------------------------------------------------|
| F <sub>w</sub> | C <sub>1</sub> | d  | r <sub>1,2</sub> min | d <sub>a</sub>                 | D <sub>a</sub> max | C <sub>a</sub> | r <sub>a</sub> max | d <sub>i</sub>                                  | F  | B <sub>i</sub> | Designation     |                                                 |
| mm             |                |    |                      |                                |                    |                |                    |                                                 |    |                |                 |                                                 |
| <b>7</b>       | 4,7            | 7  | 0,3                  | 9,5                            | 12                 | 10             | 0,3                | –                                               | –  | –              | –               | SW 14                                           |
|                | 4,7            | 7  | 0,3                  | 9,5                            | 12                 | 10             | 0,3                | –                                               | –  | –              | –               | SW 14                                           |
| <b>10</b>      | 4,7            | 10 | 0,3                  | 14,5                           | 17                 | 10             | 0,3                | 6                                               | 10 | 10             | IR 6×10×10 IS1  | SW 19                                           |
|                | 4,7            | 10 | 0,3                  | 14,5                           | 17                 | 10             | 0,3                | 6                                               | 10 | 10             | IR 6×10×10 IS1  | SW 19                                           |
| <b>12</b>      | 4,7            | 12 | 0,3                  | 16,5                           | 19                 | 10             | 0,3                | 8                                               | 12 | 10             | IR 8×12×10 IS1  | SW 21                                           |
|                | 4,7            | 12 | 0,3                  | 16,5                           | 19                 | 10             | 0,3                | 8                                               | 12 | 10             | IR 8×12×10 IS1  | SW 21                                           |
| <b>15</b>      | 8              | 15 | 0,3                  | 19                             | 22                 | 12,2           | 0,3                | 12                                              | 15 | 16             | IR 12×15×16     | SW 24                                           |
|                | 8              | 15 | 0,3                  | 19                             | 22                 | 12,2           | 0,3                | 12                                              | 15 | 16             | IR 12×15×16     | SW 24                                           |
| <b>17</b>      | 8              | 17 | 0,3                  | 21                             | 24                 | 12,2           | 0,3                | 14                                              | 17 | 17             | IR 14×17×17     | SW 26                                           |
|                | 8              | 17 | 0,3                  | 21                             | 24                 | 12,2           | 0,3                | 14                                              | 17 | 17             | IR 14×17×17     | SW 26                                           |
| <b>20</b>      | 8              | 20 | 0,3                  | 25                             | 28                 | 12,2           | 0,3                | 17                                              | 20 | 16             | IR 17×20×16     | SW 30                                           |
|                | 8              | 20 | 0,3                  | 25                             | 28                 | 12,2           | 0,3                | 17                                              | 20 | 16             | IR 17×20×16     | SW 30                                           |
| <b>25</b>      | 8              | 25 | 0,3                  | 31,5                           | 35                 | 14,2           | 0,3                | 20                                              | 25 | 16             | IR 20×25×16 IS1 | SW 37                                           |
|                | 8              | 25 | 0,3                  | 31,5                           | 35                 | 14,2           | 0,3                | 20                                              | 25 | 16             | IR 20×25×16 IS1 | SW 37                                           |
| <b>30</b>      | 10             | 30 | 0,3                  | 36,5                           | 40                 | 14,2           | 0,3                | 25                                              | 30 | 20             | IR 25×30×20     | SW 42                                           |
|                | 10             | 30 | 0,3                  | 36,5                           | 40                 | 14,2           | 0,3                | 25                                              | 30 | 20             | IR 30×35×20     | SW 42                                           |
| <b>35</b>      | 10             | 35 | 0,3                  | 40,5                           | 45                 | 14,2           | 0,3                | 30                                              | 35 | 20             | IR 25×30×20     | SW 47                                           |
|                | 10             | 35 | 0,3                  | 40,5                           | 45                 | 14,2           | 0,3                | 30                                              | 35 | 20             | IR 30×35×20     | SW 47                                           |

<sup>2)</sup> For additional information, refer to the section *Needle roller bearing inner rings*, starting on page 196.

<sup>3)</sup> In accordance with DIN 471, not supplied by SKF

# Needle roller / thrust ball bearings, thrust bearing with a cage

## F<sub>w</sub> 10 – 70 mm

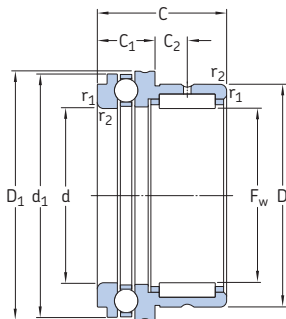

NKX

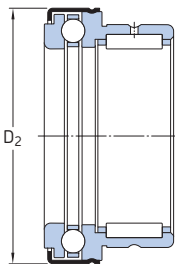

NKX..Z

| Principal dimensions | Basic load ratings |    |      |          |                        |                       | Fatigue load limits   |                      | Min. load factor A | Speed ratings   |                | Mass   | Designation |                                                                 |
|----------------------|--------------------|----|------|----------|------------------------|-----------------------|-----------------------|----------------------|--------------------|-----------------|----------------|--------|-------------|-----------------------------------------------------------------|
|                      | F <sub>w</sub>     | D  | C    | radial C | dynamic C <sub>0</sub> | static C <sub>0</sub> | radial P <sub>u</sub> | axial P <sub>u</sub> |                    | Reference speed | Limiting speed |        |             |                                                                 |
| mm                   | kN                 |    |      |          |                        |                       | kN                    |                      | –                  | r/min           | kg             | –      |             |                                                                 |
| <b>10</b>            | 19                 | 23 | 23   | 5,94     | 8                      | 9,95                  | 15,3                  | 0,9                  | 0,56               | 1,2             | 9 500          | 13 000 | 0,034       | <b>NKX 10 TN<sup>1)</sup></b><br><b>NKX 10 ZTN<sup>1)</sup></b> |
|                      | 19                 | 23 | 23   | 5,94     | 8                      | 9,95                  | 15,3                  | 0,9                  | 0,56               | 1,2             | 9 500          | 8 000  | 0,036       |                                                                 |
| <b>12</b>            | 21                 | 23 | 23   | 6,16     | 8,65                   | 10,4                  | 16,6                  | 0,98                 | 0,62               | 1,4             | 9 000          | 13 000 | 0,038       | <b>NKX 12</b><br><b>NKX 12 Z</b>                                |
|                      | 21                 | 23 | 23   | 6,16     | 8,65                   | 10,4                  | 16,6                  | 0,98                 | 0,62               | 1,4             | 9 000          | 7 500  | 0,04        |                                                                 |
| <b>15</b>            | 24                 | 23 | 23   | 11,2     | 14                     | 10,6                  | 18,3                  | 1,66                 | 0,67               | 1,7             | 8 500          | 12 000 | 0,044       | <b>NKX 15</b><br><b>NKX 15 Z</b>                                |
|                      | 24                 | 23 | 23   | 11,2     | 14                     | 10,6                  | 18,3                  | 1,66                 | 0,67               | 1,7             | 8 500          | 7 000  | 0,047       |                                                                 |
| <b>17</b>            | 26                 | 25 | 25   | 12,3     | 16,6                   | 10,8                  | 19,6                  | 1,96                 | 0,735              | 2               | 8 500          | 12 000 | 0,053       | <b>NKX 17</b><br><b>NKX 17 Z</b>                                |
|                      | 26                 | 25 | 25   | 12,3     | 16,6                   | 10,8                  | 19,6                  | 1,96                 | 0,735              | 2               | 8 500          | 7 000  | 0,055       |                                                                 |
| <b>20</b>            | 30                 | 30 | 30   | 16,8     | 26                     | 14,3                  | 27                    | 3,05                 | 1                  | 3,8             | 7 500          | 10 000 | 0,083       | <b>NKX 20</b><br><b>NKX 20 Z</b>                                |
|                      | 30                 | 30 | 30   | 16,8     | 26                     | 14,3                  | 27                    | 3,05                 | 1                  | 3,8             | 7 500          | 6 000  | 0,09        |                                                                 |
| <b>25</b>            | 37                 | 30 | 19   | 32,5     | 19,5                   | 40,5                  | 4                     | 4                    | 1,5                | 8,5             | 6 300          | 9 000  | 0,13        | <b>NKX 25</b><br><b>NKX 25 Z</b>                                |
|                      | 37                 | 30 | 19   | 32,5     | 19,5                   | 40,5                  | 4                     | 4                    | 1,5                | 8,5             | 6 300          | 5 500  | 0,13        |                                                                 |
| <b>30</b>            | 42                 | 30 | 22,9 | 39       | 20,3                   | 45,5                  | 4,8                   | 4,8                  | 1,7                | 10              | 6 000          | 8 500  | 0,14        | <b>NKX 30</b><br><b>NKX 30 Z</b>                                |
|                      | 42                 | 30 | 22,9 | 39       | 20,3                   | 45,5                  | 4,8                   | 4,8                  | 1,7                | 10              | 6 000          | 5 000  | 0,15        |                                                                 |
| <b>35</b>            | 47                 | 30 | 24,6 | 45       | 21,2                   | 51                    | 5,6                   | 5,6                  | 1,9                | 13              | 5 600          | 7 500  | 0,16        | <b>NKX 35</b><br><b>NKX 35 Z</b>                                |
|                      | 47                 | 30 | 24,6 | 45       | 21,2                   | 51                    | 5,6                   | 5,6                  | 1,9                | 13              | 5 600          | 4 500  | 0,17        |                                                                 |
| <b>40</b>            | 52                 | 32 | 26,4 | 51       | 27                     | 68                    | 6,3                   | 6,3                  | 2,55               | 24              | 5 000          | 7 000  | 0,2         | <b>NKX 40</b><br><b>NKX 40 Z</b>                                |
|                      | 52                 | 32 | 26,4 | 51       | 27                     | 68                    | 6,3                   | 6,3                  | 2,55               | 24              | 5 000          | 4 000  | 0,21        |                                                                 |
| <b>45</b>            | 58                 | 32 | 28,1 | 57       | 28,1                   | 75                    | 7,1                   | 7,1                  | 2,8                | 29              | 4 500          | 6 300  | 0,25        | <b>NKX 45</b><br><b>NKX 45 Z</b>                                |
|                      | 58                 | 32 | 28,1 | 57       | 28,1                   | 75                    | 7,1                   | 7,1                  | 2,8                | 29              | 4 500          | 3 800  | 0,27        |                                                                 |
| <b>50</b>            | 62                 | 35 | 38   | 80       | 28,6                   | 81,5                  | 9,65                  | 9,65                 | 3,05               | 34              | 4 300          | 6 300  | 0,28        | <b>NKX 50</b><br><b>NKX 50 Z</b>                                |
|                      | 62                 | 35 | 38   | 80       | 28,6                   | 81,5                  | 9,65                  | 9,65                 | 3,05               | 34              | 4 300          | 3 600  | 0,3         |                                                                 |
| <b>60</b>            | 72                 | 40 | 41,8 | 96,5     | 41,6                   | 122                   | 11,8                  | 11,8                 | 4,55               | 77              | 3 600          | 5 000  | 0,36        | <b>NKX 60</b><br><b>NKX 60 Z</b>                                |
|                      | 72                 | 40 | 41,8 | 96,5     | 41,6                   | 122                   | 11,8                  | 11,8                 | 4,55               | 77              | 3 600          | 3 000  | 0,38        |                                                                 |
| <b>70</b>            | 85                 | 40 | 44,6 | 98       | 43,6                   | 137                   | 12,2                  | 12,2                 | 5,1                | 97              | 3 400          | 4 500  | 0,5         | <b>NKX 70</b><br><b>NKX 70 Z</b>                                |
|                      | 85                 | 40 | 44,6 | 98       | 43,6                   | 137                   | 12,2                  | 12,2                 | 5,1                | 97              | 3 400          | 2 700  | 0,52        |                                                                 |

<sup>1)</sup> Radial bearing with inserted closure ring

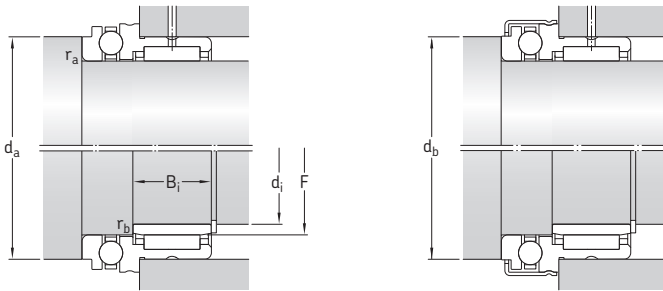

| Dimensions     |                |                |    |                |                |                |                      | Abutment and fillet dimensions |                    |                    |                    |                |    |                | Appropriate inner ring <sup>2)</sup> Designation |
|----------------|----------------|----------------|----|----------------|----------------|----------------|----------------------|--------------------------------|--------------------|--------------------|--------------------|----------------|----|----------------|--------------------------------------------------|
| F <sub>w</sub> | C <sub>1</sub> | C <sub>2</sub> | d  | d <sub>1</sub> | D <sub>1</sub> | D <sub>2</sub> | r <sub>1,2</sub> min | d <sub>a</sub> min             | d <sub>b</sub> max | r <sub>a</sub> max | r <sub>b</sub> max | d <sub>i</sub> | F  | B <sub>i</sub> |                                                  |
| mm             |                |                |    |                |                |                |                      | mm                             |                    |                    |                    |                |    |                | –                                                |
| 10             | 9              | 6,5            | 10 | 24             | 24             | –              | 0,3                  | 19                             | –                  | 0,3                | 0,3                | 7              | 10 | 16             | IR 7×10×16                                       |
|                | 9              | 6,5            | 10 | 19,7           | –              | 25,2           | 0,3                  | 19                             | 19,7               | 0,3                | 0,3                | 7              | 10 | 16             | IR 7×10×16                                       |
| 12             | 9              | 6,5            | 12 | 26             | 26             | –              | 0,3                  | 21                             | –                  | 0,3                | 0,3                | 9              | 12 | 16             | IR 9×12×16                                       |
|                | 9              | 6,5            | 12 | 21,7           | –              | 27,2           | 0,3                  | 21                             | 21,7               | 0,3                | 0,3                | 9              | 12 | 16             | IR 9×12×16                                       |
| 15             | 9              | 6,5            | 15 | 28             | 28             | –              | 0,3                  | 23                             | –                  | 0,3                | 0,3                | 12             | 15 | 16             | IR 12×15×16                                      |
|                | 9              | 6,5            | 15 | 23,7           | –              | 29,2           | 0,3                  | 23                             | 23,7               | 0,3                | 0,3                | 12             | 15 | 16             | IR 12×15×16                                      |
| 17             | 9              | 8              | 17 | 30             | 30             | –              | 0,3                  | 25                             | –                  | 0,3                | 0,3                | 14             | 17 | 17             | IR 14×17×17                                      |
|                | 9              | 8              | 17 | 25,7           | –              | 31,1           | 0,3                  | 25                             | 25,7               | 0,3                | 0,3                | 14             | 17 | 17             | IR 14×17×17                                      |
| 20             | 10             | 10,5           | 20 | 35             | 35             | –              | 0,3                  | 29                             | –                  | 0,3                | 0,3                | 17             | 20 | 20             | IR 17×20×20                                      |
|                | 10             | 10,5           | 20 | 30,7           | –              | 36,2           | 0,3                  | 29                             | 30,7               | 0,3                | 0,3                | 17             | 20 | 20             | IR 17×20×20                                      |
| 25             | 11             | 9,5            | 25 | 42             | 42             | –              | 0,6                  | 35                             | –                  | 0,6                | 0,3                | 20             | 25 | 20             | IR 20×25×20                                      |
|                | 11             | 9,5            | 25 | 37,7           | –              | 43,2           | 0,6                  | 35                             | 37,7               | 0,6                | 0,3                | 20             | 25 | 20             | IR 20×25×20                                      |
| 30             | 11             | 9,5            | 30 | 47             | 47             | –              | 0,6                  | 40                             | –                  | 0,6                | 0,3                | 25             | 30 | 20             | IR 25×30×20                                      |
|                | 11             | 9,5            | 30 | 42,7           | –              | 48,2           | 0,6                  | 40                             | 42,7               | 0,6                | 0,3                | 25             | 30 | 20             | IR 25×30×20                                      |
| 35             | 12             | 9              | 35 | 52             | 52             | –              | 0,6                  | 45                             | –                  | 0,6                | 0,3                | 30             | 35 | 20             | IR 30×35×20                                      |
|                | 12             | 9              | 35 | 47,7           | –              | 53,2           | 0,6                  | 45                             | 47,7               | 0,6                | 0,3                | 30             | 35 | 20             | IR 30×35×20                                      |
| 40             | 13             | 10             | 40 | 60             | 60             | –              | 0,6                  | 52                             | –                  | 0,6                | 0,3                | 35             | 40 | 20             | IR 35×40×20                                      |
|                | 13             | 10             | 40 | 55,7           | –              | 61,2           | 0,6                  | 52                             | 55,7               | 0,6                | 0,3                | 35             | 40 | 20             | IR 35×40×20                                      |
| 45             | 14             | 9              | 45 | 65             | 65             | –              | 0,6                  | 57                             | –                  | 0,6                | 0,3                | 40             | 45 | 20             | IR 40×45×20                                      |
|                | 14             | 9              | 45 | 60,5           | –              | 66,5           | 0,6                  | 57                             | 60,5               | 0,6                | 0,3                | 40             | 45 | 20             | IR 40×45×20                                      |
| 50             | 14             | 10             | 50 | 70             | 70             | –              | 0,6                  | 62                             | –                  | 0,6                | 0,3                | 45             | 50 | 25             | IR 45×50×25                                      |
|                | 14             | 10             | 50 | 65,5           | –              | 71,5           | 0,6                  | 62                             | 65,5               | 0,6                | 0,3                | 45             | 50 | 25             | IR 45×50×25                                      |
| 60             | 17             | 12             | 60 | 85             | 85             | –              | 1                    | 75                             | –                  | 1                  | 1                  | 50             | 60 | 25             | IR 50×60×25                                      |
|                | 17             | 12             | 60 | 80,5           | –              | 86,5           | 1                    | 75                             | 80,5               | 1                  | 1                  | 50             | 60 | 25             | IR 50×60×25                                      |
| 70             | 18             | 11             | 70 | 95             | 95             | –              | 1                    | 85                             | –                  | 1                  | 1                  | 60             | 70 | 25             | IR 60×70×25                                      |
|                | 18             | 11             | 70 | 90,5           | –              | 96,5           | 1                    | 85                             | 90,5               | 1                  | 1                  | 60             | 70 | 25             | IR 60×70×25                                      |

<sup>2)</sup> For additional information, refer to the section *Needle roller bearing inner rings*, starting on **page 196**.

## Needle roller / cylindrical roller thrust bearings

Needle roller / cylindrical roller thrust bearings combine a radial needle roller bearing and a cylindrical roller thrust bearing based on the 811 series. SKF supplies these bearings in the following two series:

- NKXR series (→ **fig. 19**), cylindrical roller thrust bearing is separable
- NKXR .. Z series (→ **fig. 20**), non-separable bearing

These bearings are supplied without an inner ring. For applications where it is not possible to harden and grind the shaft, the bearings can be combined with an inner ring (→ **fig. 21**). Appropriate inner rings are listed in the product tables and can be ordered separately.

### Needle roller / cylindrical roller thrust bearings, NKXR series

SKF needle roller / cylindrical roller thrust bearings in the NKXR series (→ **fig. 19**) are separable. Both the cylindrical roller and cage thrust assembly and shaft washer can be mounted separately from the rest of the bearing.

### Needle roller / cylindrical roller thrust bearings, NKXR .. Z series

SKF needle roller / cylindrical roller thrust bearings in the NKXR .. Z series (→ **fig. 20**) are non-separable. They have a stamped steel cover that extends over the shaft washer of the cylindrical roller thrust bearing. It is firmly attached to the housing washer that is integral to the needle roller bearing outer ring. The cover makes these bearings non-separable. SKF supplies the cylindrical roller thrust bearing in this series filled, as standard, with a high-quality grease that has good rust inhibiting properties. The cover, which has no lubrication holes, forms a gap-type seal with the shaft washer to retain the grease in the bearing.

Fig. 19

Needle roller / cylindrical roller thrust bearing

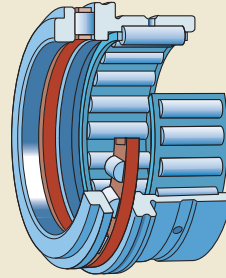

NKXR series

Fig. 20

Needle roller / cylindrical roller thrust bearing

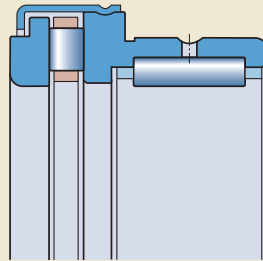

NKXR .. Z series

Fig. 21

Needle roller / cylindrical roller thrust bearing, NKXR .. Z series, combined with an inner ring

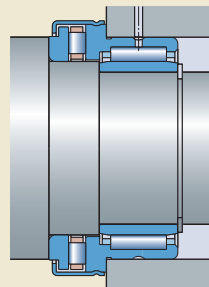

## Dimensions

The boundary dimensions of the single direction needle roller / cylindrical roller thrust bearings are in accordance with DIN 5429-1:2005-08.

## Tolerances

SKF needle roller / cylindrical roller thrust bearings are manufactured to the tolerances and tolerance classes listed in **table 3**. The radial runout values are in accordance with ISO 492:2002 and the axial runout values are in accordance with Normal tolerance class of ISO 199:2005.

The values for the deviations from the nominal diameter of the ISO tolerance classes F6 and E8 in **table 3** are listed in **table 4**.

## Shaft and housing tolerances

SKF recommends machining the shaft seat for needle roller / cylindrical roller thrust bearings to a k5 tolerance class for bearings with or without an inner ring.

For the housing bore seat, SKF recommends a K6 tolerance class. For stiff bearing arrangements, SKF recommends an M6 housing bore tolerance class.

In addition to their interference fit on the shaft and in the housing, the bearing rings must be axially located by a shaft shoulder or locating ring.

## Internal clearance

SKF needle roller / cylindrical roller thrust bearings combined with the appropriate inner ring, as listed in the product tables, have Normal radial internal clearance as standard. The clearance values are listed in **table 7** on **page 42** and are in accordance with ISO 5753-1:2009. They are valid for unmounted bearings under zero measuring load.

The radial internal clearance for SKF needle roller / cylindrical roller thrust bearings without an inner ring depends on the shaft tolerance. If the recommended k5 shaft tolerance class is applied, the tolerance for the inside diameter  $F_w$  will provide an internal clearance that is slightly less than the Normal radial internal clearance.

Table 3

### Needle roller / cylindrical roller thrust bearing tolerances

| Dimension <sup>1)</sup>                     |       | Tolerance, tolerance class |
|---------------------------------------------|-------|----------------------------|
| Outside diameter                            | D     | Normal, ISO 492:1994       |
| Inside diameter of needle roller complement | $F_w$ | F6                         |
| Bore diameter                               | d     | E8                         |
| Width                                       | C     | 0/-0,25 mm                 |
| Width                                       | $C_1$ | 0/-0,20 mm                 |

<sup>1)</sup> Refer to the illustrations in the product table on **page 192**

Table 4

### ISO tolerance classes

| Nominal diameter | E8        | Deviations    |     | F6            |     |
|------------------|-----------|---------------|-----|---------------|-----|
|                  |           | high          | low | high          | low |
| over incl.       |           |               |     |               |     |
| mm               |           | $\mu\text{m}$ |     | $\mu\text{m}$ |     |
| <b>6</b>         | <b>10</b> | +47           | +25 | +22           | +13 |
| <b>10</b>        | <b>18</b> | +59           | +32 | +27           | +16 |
| <b>18</b>        | <b>30</b> | +73           | +40 | +33           | +20 |
| <b>30</b>        | <b>50</b> | +89           | +50 | +41           | +25 |
| <b>50</b>        | <b>80</b> | +106          | +60 | +49           | +30 |

### Misalignment

Needle roller / cylindrical roller thrust bearings cannot accommodate any angular misalignment of the shaft relative to the housing, or between the axial support surfaces on the shaft or in the housing.

### Cages

The radial needle roller bearing is fitted as standard with a machined steel cage (→ **fig. 4, page 172**) or a sheet steel cage (→ **fig. 5, page 172**).

The cage that retains the rollers of the cylindrical roller thrust bearing is made of glass fibre reinforced polyamide 66 (→ **fig. 22**).

### Note

Needle roller / cylindrical roller thrust bearings should not be operated at temperatures above 120 °C.

The lubricants generally used for rolling bearings do not have a detrimental effect on cage properties. Exceptions are a few synthetic oils and greases with a synthetic oil base and lubricants containing a high proportion of EP additives when used at high temperatures.

For detailed information about the temperature resistance and the applicability of cages, refer to the section *Cage materials*, starting on **page 44**.

### Lubrication

To promote efficient lubrication, SKF needle roller / cylindrical roller thrust bearings have an annular groove with lubrication holes in the outer ring of the needle roller bearing.

The shielded thrust bearing of needle roller / cylindrical roller thrust bearings, in the NKXR ..Z series, is filled at the factory with a high-quality grease with good corrosion inhibiting properties. SKF recommends SKF LGWA 2 grease for relubrication. For additional information about greases, refer to the section *Lubrication*, starting on **page 52**.

Bearings in the NKXR series, without the designation suffix Z, should be oil lubricated whenever possible, as oil facilitates an adequate supply of lubricant to the bearing.

Relubrication intervals for the needle roller bearing and cylindrical roller thrust bearing must be calculated separately. The lower of the two intervals should be used. A calculation is necessary for both oil and grease lubrication.

Fig. 22

Polyamide 66 cage of the cylindrical roller thrust bearing





## Design of associated components

The diameter of the support surface for the integral housing washer of needle roller / cylindrical roller thrust bearings must always be at least 0,5 mm larger than the dimension  $D_1$  or  $D_2$  (→ **fig. 23**) to obtain a clearance fit. The values for the diameters  $D_1$  and  $D_2$  are listed in the product table.

## Application recommendations

SKF needle roller / cylindrical roller thrust bearings can locate a shaft axially in one direction. For short shafts, where changes in length as a result of thermal expansion are relatively minor, two bearings can be used in a back-to-back (mirrored) arrangement (→ **fig. 24**). In these cases, SKF recommends elastically preloading the cylindrical roller thrust bearings with cup springs (belleville washers). This elastic preload helps to avoid skidding of the rolling elements when one of the thrust bearings is unloaded. Elastic preload also reduces the noise level of the cylindrical roller thrust bearing.

## Supplementary designations

The designation suffixes used to identify certain features of SKF needle roller / cylindrical roller thrust bearings are explained in the following.

- Z Cylindrical roller thrust bearing with a cover over the outside diameter without lubrication holes. Filled at the factory with a high-quality lithium base NLGI 2 grease.

Fig. 23

Clearance fit for the integral housing washer

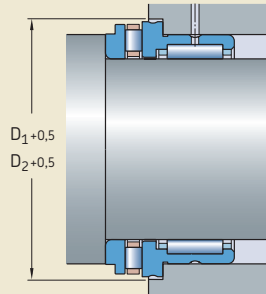
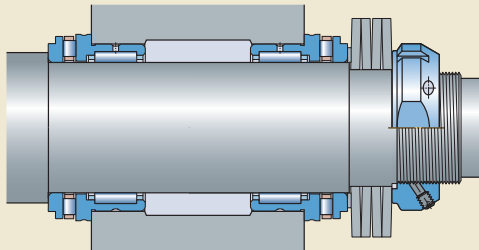

Fig. 24

NKXR series, back-to-back arrangement



# Needle roller / cylindrical roller thrust bearings

F<sub>w</sub> 15 – 50 mm

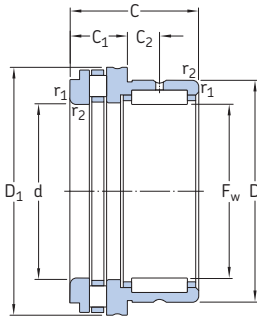

NKXR

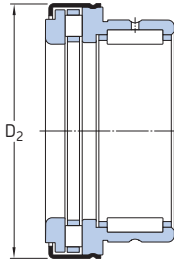

NKXR..Z

| Principal dimensions | Basic load ratings |    |      |                  |                       |                 | Fatigue load limits   |                       | Min. load factor<br>A | Speed ratings        |                 | Mass  | Designation      |
|----------------------|--------------------|----|------|------------------|-----------------------|-----------------|-----------------------|-----------------------|-----------------------|----------------------|-----------------|-------|------------------|
|                      | F <sub>w</sub>     | D  | C    | radial dynamic C | static C <sub>0</sub> | axial dynamic C | static C <sub>0</sub> | radial P <sub>u</sub> |                       | axial P <sub>u</sub> | Reference speed |       |                  |
| mm                   | kN                 |    |      |                  |                       |                 | kN                    |                       | –                     | r/min                |                 | kg    | –                |
| <b>15</b>            | 24                 | 23 | 11,2 | 14               | 11,2                  | 27              | 1,66                  | 2,45                  | 0,058                 | 4 300                | 8 500           | 0,042 | <b>NKXR 15</b>   |
|                      | 24                 | 23 | 11,2 | 14               | 11,2                  | 27              | 1,66                  | 2,45                  | 0,058                 | 4 300                | 8 500           | 0,045 | <b>NKXR 15 Z</b> |
| <b>17</b>            | 26                 | 25 | 12,3 | 16,6             | 12,2                  | 31,5            | 1,96                  | 2,85                  | 0,079                 | 4 300                | 8 500           | 0,05  | <b>NKXR 17</b>   |
|                      | 26                 | 25 | 12,3 | 16,6             | 12,2                  | 31,5            | 1,96                  | 2,85                  | 0,079                 | 4 300                | 8 500           | 0,053 | <b>NKXR 17 Z</b> |
| <b>20</b>            | 30                 | 30 | 16,8 | 26               | 18,6                  | 48              | 3,05                  | 4,65                  | 0,18                  | 3 800                | 7 500           | 0,08  | <b>NKXR 20</b>   |
|                      | 30                 | 30 | 16,8 | 26               | 18,6                  | 48              | 3,05                  | 4,65                  | 0,18                  | 3 800                | 7 500           | 0,084 | <b>NKXR 20 Z</b> |
| <b>25</b>            | 37                 | 30 | 19   | 32,5             | 25                    | 69,5            | 4                     | 6,8                   | 0,39                  | 3 200                | 6 300           | 0,12  | <b>NKXR 25</b>   |
|                      | 37                 | 30 | 19   | 32,5             | 25                    | 69,5            | 4                     | 6,8                   | 0,39                  | 3 200                | 6 300           | 0,13  | <b>NKXR 25 Z</b> |
| <b>30</b>            | 42                 | 30 | 22,9 | 39               | 27                    | 78              | 4,8                   | 7,65                  | 0,49                  | 3 000                | 6 000           | 0,14  | <b>NKXR 30</b>   |
|                      | 42                 | 30 | 22,9 | 39               | 27                    | 78              | 4,8                   | 7,65                  | 0,49                  | 3 000                | 6 000           | 0,14  | <b>NKXR 30 Z</b> |
| <b>35</b>            | 47                 | 30 | 24,6 | 45               | 29                    | 93              | 5,6                   | 9,15                  | 0,69                  | 2 800                | 5 600           | 0,16  | <b>NKXR 35</b>   |
|                      | 47                 | 30 | 24,6 | 45               | 29                    | 93              | 5,6                   | 9,15                  | 0,69                  | 2 800                | 5 600           | 0,17  | <b>NKXR 35 Z</b> |
| <b>40</b>            | 52                 | 32 | 26,4 | 51               | 43                    | 137             | 6,3                   | 13,7                  | 1,5                   | 2 400                | 5 000           | 0,2   | <b>NKXR 40</b>   |
|                      | 52                 | 32 | 26,4 | 51               | 43                    | 137             | 6,3                   | 13,7                  | 1,5                   | 2 400                | 5 000           | 0,21  | <b>NKXR 40 Z</b> |
| <b>45</b>            | 58                 | 32 | 28,1 | 57               | 45                    | 153             | 7,1                   | 15,3                  | 1,9                   | 2 200                | 4 500           | 0,24  | <b>NKXR 45</b>   |
|                      | 58                 | 32 | 28,1 | 57               | 45                    | 153             | 7,1                   | 15,3                  | 1,9                   | 2 200                | 4 500           | 0,26  | <b>NKXR 45 Z</b> |
| <b>50</b>            | 62                 | 35 | 38   | 80               | 47,5                  | 166             | 9,65                  | 16,6                  | 2,2                   | 2 200                | 4 300           | 0,27  | <b>NKXR 50</b>   |
|                      | 62                 | 35 | 38   | 80               | 47,5                  | 166             | 9,65                  | 16,6                  | 2,2                   | 2 200                | 4 300           | 0,29  | <b>NKXR 50 Z</b> |

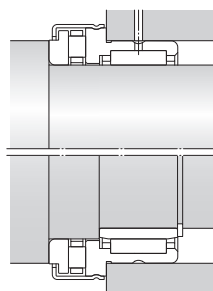
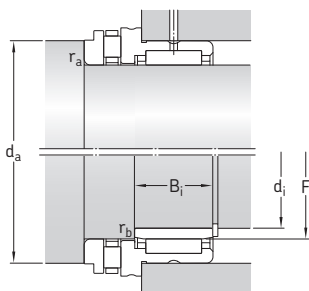

| Dimensions     |                |                |    |                |                |                      | Abutment and fillet dimensions |                    |                    |                |    |                | Appropriate inner ring <sup>1)</sup> Designation |
|----------------|----------------|----------------|----|----------------|----------------|----------------------|--------------------------------|--------------------|--------------------|----------------|----|----------------|--------------------------------------------------|
| F <sub>w</sub> | C <sub>1</sub> | C <sub>2</sub> | d  | D <sub>1</sub> | D <sub>2</sub> | r <sub>1,2</sub> min | d <sub>a</sub>                 | r <sub>a</sub> max | r <sub>b</sub> max | d <sub>i</sub> | F  | B <sub>i</sub> |                                                  |
| mm             |                |                |    |                |                |                      | mm                             |                    |                    |                |    |                | -                                                |
| 15             | 9              | 6,5            | 15 | 28             | -              | 0,3                  | 23,7                           | 0,3                | 0,3                | 12             | 15 | 16             | IR 12×15×16                                      |
|                | 9              | 6,5            | 15 | -              | 29,2           | 0,3                  | 23,7                           | 0,3                | 0,3                | 12             | 15 | 16             | IR 12×15×16                                      |
| 17             | 9              | 8              | 17 | 30             | -              | 0,3                  | 25,7                           | 0,3                | 0,3                | 14             | 17 | 17             | IR 14×17×17                                      |
|                | 9              | 8              | 17 | -              | 31,2           | 0,3                  | 25,7                           | 0,3                | 0,3                | 14             | 17 | 17             | IR 14×17×17                                      |
| 20             | 10             | 10,5           | 20 | 35             | -              | 0,3                  | 30,7                           | 0,3                | 0,3                | 17             | 20 | 20             | IR 17×20×20                                      |
|                | 10             | 10,5           | 20 | -              | 36,2           | 0,3                  | 30,7                           | 0,3                | 0,3                | 17             | 20 | 20             | IR 17×20×20                                      |
| 25             | 11             | 9,5            | 25 | 42             | -              | 0,6                  | 37,7                           | 0,6                | 0,3                | 20             | 25 | 20             | IR 20×25×20                                      |
|                | 11             | 9,5            | 25 | -              | 43,2           | 0,6                  | 37,7                           | 0,6                | 0,3                | 20             | 25 | 20             | IR 20×25×20                                      |
| 30             | 11             | 9,5            | 30 | 47             | -              | 0,6                  | 42,7                           | 0,6                | 0,3                | 25             | 30 | 20             | IR 25×30×20                                      |
|                | 11             | 9,5            | 30 | -              | 48,2           | 0,6                  | 42,7                           | 0,6                | 0,3                | 25             | 30 | 20             | IR 25×30×20                                      |
| 35             | 12             | 9              | 35 | 52             | -              | 0,6                  | 47,7                           | 0,6                | 0,3                | 30             | 35 | 20             | IR 30×35×20                                      |
|                | 12             | 9              | 35 | -              | 53,2           | 0,6                  | 47,7                           | 0,6                | 0,3                | 30             | 35 | 20             | IR 30×35×20                                      |
| 40             | 13             | 10             | 40 | 60             | -              | 0,6                  | 55,7                           | 0,6                | 0,3                | 35             | 40 | 20             | IR 35×40×20                                      |
|                | 13             | 10             | 40 | -              | 61,2           | 0,6                  | 55,7                           | 0,6                | 0,3                | 35             | 40 | 20             | IR 35×40×20                                      |
| 45             | 14             | 9              | 45 | 65             | -              | 0,6                  | 60,6                           | 0,6                | 0,3                | 40             | 45 | 20             | IR 40×45×20                                      |
|                | 14             | 9              | 45 | -              | 66,5           | 0,6                  | 60,6                           | 0,6                | 0,3                | 40             | 45 | 20             | IR 40×45×20                                      |
| 50             | 14             | 10             | 50 | 70             | -              | 0,6                  | 65,6                           | 0,6                | 0,3                | 45             | 50 | 25             | IR 45×50×25                                      |
|                | 14             | 10             | 50 | -              | 71,5           | 0,6                  | 65,6                           | 0,6                | 0,3                | 45             | 50 | 25             | IR 45×50×25                                      |

<sup>1)</sup> For additional information, refer to the section *Needle roller bearing inner rings*, starting on **page 196**.



# Needle roller bearing components

|                                                                   |            |
|-------------------------------------------------------------------|------------|
| <b>Needle roller bearing inner rings .....</b>                    | <b>196</b> |
| Inner rings in the IR series .....                                | 196        |
| Tolerances .....                                                  | 196        |
| Internal clearance .....                                          | 197        |
| Raceways with a machining allowance .....                         | 197        |
| Inner rings in the LR series .....                                | 197        |
| Tolerances .....                                                  | 198        |
| Inner ring seats .....                                            | 198        |
| Shaft diameter tolerances .....                                   | 198        |
| Cylindricity .....                                                | 198        |
| Runout .....                                                      | 198        |
| Supplementary designations .....                                  | 199        |
| Product tables .....                                              | 200        |
| 8.1 Needle roller bearing inner rings .....                       | 200        |
| <b>Needle rollers .....</b>                                       | <b>204</b> |
| Materials .....                                                   | 204        |
| Tolerances .....                                                  | 204        |
| Supplementary designations .....                                  | 205        |
| Product tables .....                                              | 206        |
| 8.2 Needle rollers .....                                          | 206        |
| <b>Radial shaft seals with a low cross sectional height .....</b> | <b>208</b> |
| G design radial shaft seals .....                                 | 208        |
| SD design radial shaft seals .....                                | 208        |
| Design of associated components .....                             | 209        |
| Speeds .....                                                      | 210        |
| Operating temperature range .....                                 | 210        |
| Mounting instructions .....                                       | 210        |
| Product tables .....                                              | 212        |
| 8.3 Radial shaft seals with a low cross sectional height .....    | 212        |

## Needle roller bearing inner rings

SKF supplies inner rings for needle roller bearings separately. They are primarily used in conjunction with needle roller and cage assemblies and drawn cup needle roller bearings in applications where the shaft cannot be ground and hardened to a suitable raceway tolerance. Extended inner rings are also available. These permit greater axial displacement of the shaft, relative to the housing, compared to standard width inner rings. They also provide an excellent counterface for the lips of contact seals.

SKF supplies needle roller bearing inner rings in the following two series:

- inner rings in the IR series (→ **fig. 1**), with or without a lubrication hole, with or without machining allowance
- inner rings in the LR series (→ **fig. 2**).

Regardless of whether the ring has an interference or loose fit, it should be located to the shaft by either a shoulder or snap ring to prevent axial movements.

### Inner rings in the IR series

Inner rings in the IR series (→ **fig. 1**) are the standard SKF inner rings for needle roller bearings. They are made of carbon chromium bearing steel that has been hardened and ground. The raceway surface, which is precision machined, has a lead-in chamfer on both sides to simplify assembly. The chamfer also protects the sealing lips from damage during the mounting process.

Some sizes of IR inner rings have a lubrication hole (→ **fig. 3**). These inner rings are identified by the designation suffix IS1. Inner rings with additional lubrication holes are available on request.

### Tolerances

The bore diameter and the width of IR inner rings are made to Normal tolerances in accordance with ISO 492:2002.

Fig. 1

Inner ring

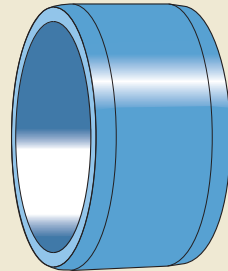

IR series

Fig. 2

Inner ring

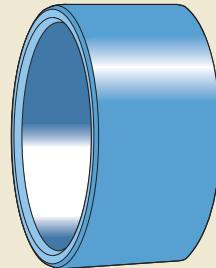

LR series

Fig. 3

Inner ring, with a lubrication hole

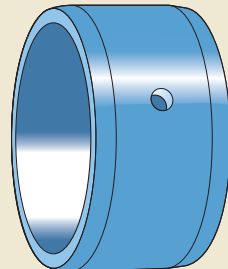

IR .. IS1 series

## Internal clearance

If the recommended shaft and housing tolerance classes are applied, the tolerances for the inner ring raceway diameter  $F$  will provide applications with the following internal clearance:

- a suitable (medium) operational clearance that will reach a value in the range of C2 to C3 radial internal clearance, when combined with SKF drawn cup needle roller bearings. The clearance value depends on the raceway diameter and the operating temperature.
- a Normal radial internal clearance, when combined with SKF needle roller bearings with a machined outer ring. The clearance values are listed in **table 7** on **page 42** and are in accordance with ISO 5753-1:2009. They are valid for unmounted bearings under zero measuring load.

## Raceways with a machining allowance

On request, SKF can supply inner rings in the IR series with a pre-ground raceway and a machining allowance  $z$ . These inner rings are identified by the designation suffix VGS. The machining allowance depends on the inner ring raceway diameter and is listed in **table 1**.

## Inner rings in the LR series

Inner rings in the LR series (→ **fig. 2**, **page 196**) are made of carbon chromium bearing steel and have been hardened. The bore and outside diameter are ground. The side faces are turned and the edges are smoothed. Therefore, they have larger tolerances than inner rings in the IR series. For applications where the larger run-out and width tolerances are less important, these inner rings can be used to provide a cost-effective bearing arrangement. They are, therefore, often combined with drawn cup needle roller bearings or needle roller and cage assemblies (→ **fig. 4**).

Table 1

| Inner ring raceway diameter |       |      | Machining allowance $z$ | Preground raceway diameter $F_{VGS}$    |
|-----------------------------|-------|------|-------------------------|-----------------------------------------|
| Raceway diameter $F$        |       |      |                         |                                         |
| over                        | incl. |      |                         |                                         |
| mm                          |       | mm   | mm                      |                                         |
| –                           | 50    | 0,10 |                         | $F_{VGS} = F + z$<br>h7 tolerance class |
| 50                          | 80    | 0,15 |                         |                                         |
| 80                          | 180   | 0,20 |                         |                                         |
| 180                         | 250   | 0,25 |                         |                                         |
| 250                         | 315   | 0,30 |                         |                                         |
| 315                         | 400   | 0,35 |                         |                                         |
| 400                         | 500   | 0,40 |                         |                                         |

Fig. 4

Inner ring, LR series, combined with a needle roller and cage assembly

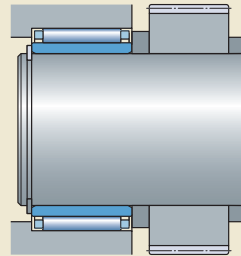

## Needle roller bearing inner rings

### Tolerances

SKF inner rings in the LR series are manufactured to the following tolerance classes:

- raceway diameter to h6 tolerance class
- width to h12 tolerance class
- bore diameter to K6 tolerance class.

The values for the deviation from the nominal dimension for these tolerances are provided in **table 2**.

### Inner ring seats

The seat for an inner ring mounted on a shaft should be in accordance with the following recommendations.

### Shaft diameter tolerances

When inner rings are used under conditions of point load and mounted with a loose fit, the seat should be machined to h6 or g6 tolerance class.

When the load rotates, the inner rings should have an interference fit. Sufficient interference can be obtained if the recommended shaft tolerance classes (→ **table 3, page 105**) are applied.

### Cylindricity

The cylindricity of an inner ring seat should be in accordance with ISO 1101:2004, corresponding to the following IT tolerance classes:

- IT5/2 for inner rings under point load
- IT4/2 for inner rings under rotating load.

### Runout

Inner ring shaft abutments should have a runout corresponding to IT4 tolerance class.

Table 2

ISO tolerance classes for LR series inner rings

| Nominal diameter | over incl. | h6              |     | h12             |      | K6              |     |
|------------------|------------|-----------------|-----|-----------------|------|-----------------|-----|
|                  |            | Deviations high | low | Deviations high | low  | Deviations high | low |
| mm               |            | μm              |     | μm              |      | μm              |     |
| <b>6</b>         | <b>10</b>  | 0               | -9  | 0               | -150 | +2              | -7  |
| <b>10</b>        | <b>18</b>  | 0               | -11 | 0               | -180 | +2              | -9  |
| <b>18</b>        | <b>30</b>  | 0               | -13 | 0               | -210 | +2              | -11 |
| <b>30</b>        | <b>50</b>  | 0               | -16 | 0               | -250 | +3              | -13 |
| <b>50</b>        | <b>80</b>  | 0               | -19 | 0               | -300 | +4              | -15 |



## Supplementary designations

The designation suffixes used to identify certain features of SKF needle roller bearing inner rings are explained in the following.

- EGS** Inner ring with non-directionally ground raceway
- IS..** Needle roller bearing with one or more lubricating holes in the inner ring, a figure following indicates the number of holes
- ISR..** Needle roller bearing with an annular groove and one or more lubricating holes in the inner ring, a figure following indicates the number of holes
- VGS** Inner ring with a pre-ground raceway and a machining allowance
- C2** Bearing internal clearance smaller than Normal
- C3** Bearing internal clearance greater than Normal
- C4** Bearing internal clearance greater than C3

## Needle roller bearing inner rings d 5 – 42 mm

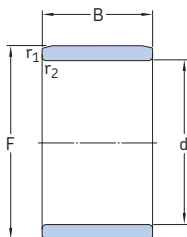

IR



IR..IS1

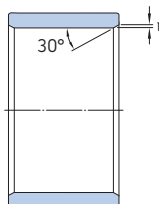

LR

| Dimensions |    |      |                  | Mass   | Designation            |
|------------|----|------|------------------|--------|------------------------|
| d          | F  | B    | r <sub>1,2</sub> |        |                        |
| mm         |    |      |                  | kg     | -                      |
| 5          | 8  | 12   | 0,3              | 0,0028 | <b>IR 5×8×12</b>       |
|            | 8  | 16   | 0,3              | 0,0038 | <b>IR 5×8×16</b>       |
| 6          | 9  | 12   | 0,3              | 0,0032 | <b>IR 6×9×12</b>       |
|            | 9  | 16   | 0,3              | 0,0043 | <b>IR 6×9×16</b>       |
|            | 10 | 10   | 0,3              | 0,0037 | <b>IR 6×10×10 IS1</b>  |
| 7          | 10 | 10,5 | 0,3              | 0,0031 | <b>IR 7×10×10,5</b>    |
|            | 10 | 10,5 | 0,3              | 0,0031 | <b>LR 7×10×10,5</b>    |
|            | 10 | 12   | 0,3              | 0,0036 | <b>IR 7×10×12</b>      |
|            | 10 | 16   | 0,3              | 0,0049 | <b>IR 7×10×16</b>      |
| 8          | 12 | 10   | 0,3              | 0,0048 | <b>IR 8×12×10 IS1</b>  |
|            | 12 | 10,5 | 0,3              | 0,005  | <b>IR 8×12×10,5</b>    |
|            | 12 | 10,5 | 0,3              | 0,005  | <b>LR 8×12×10,5</b>    |
|            | 12 | 12,5 | 0,3              | 0,0059 | <b>IR 8×12×12,5</b>    |
|            | 12 | 12,5 | 0,3              | 0,0059 | <b>LR 8×12×12,5</b>    |
| 9          | 12 | 12   | 0,3              | 0,0045 | <b>IR 9×12×12</b>      |
|            | 12 | 16   | 0,3              | 0,0061 | <b>IR 9×12×16</b>      |
| 10         | 13 | 12,5 | 0,3              | 0,0052 | <b>IR 10×13×12,5</b>   |
|            | 13 | 12,5 | 0,3              | 0,0052 | <b>LR 10×13×12,5</b>   |
|            | 14 | 12   | 0,3              | 0,0073 | <b>IR 10×14×12 IS1</b> |
|            | 14 | 13   | 0,3              | 0,0074 | <b>IR 10×14×13</b>     |
|            | 14 | 16   | 0,3              | 0,0092 | <b>IR 10×14×16</b>     |
| 12         | 15 | 12   | 0,3              | 0,0058 | <b>IR 12×15×12</b>     |
|            | 15 | 12,5 | 0,3              | 0,0061 | <b>IR 12×15×12,5</b>   |
|            | 15 | 12,5 | 0,3              | 0,0061 | <b>LR 12×15×12,5</b>   |
|            | 15 | 16   | 0,3              | 0,008  | <b>IR 12×15×16</b>     |
|            | 15 | 16,5 | 0,3              | 0,0081 | <b>IR 12×15×16,5</b>   |
|            | 15 | 16,5 | 0,3              | 0,0081 | <b>LR 12×15×16,5</b>   |
|            | 15 | 22,5 | 0,3              | 0,011  | <b>IR 12×15×22,5</b>   |
|            | 15 | 22,5 | 0,3              | 0,011  | <b>LR 12×15×22,5</b>   |
|            | 16 | 12   | 0,3              | 0,0079 | <b>IR 12×16×12 IS1</b> |
|            | 16 | 13   | 0,3              | 0,0087 | <b>IR 12×16×13</b>     |
|            | 16 | 16   | 0,3              | 0,011  | <b>IR 12×16×16</b>     |
|            | 16 | 20   | 0,3              | 0,014  | <b>IR 12×16×20</b>     |
|            | 16 | 22   | 0,3              | 0,015  | <b>IR 12×16×22</b>     |

| Dimensions |    |      |                  | Mass   | Designation            |
|------------|----|------|------------------|--------|------------------------|
| d          | F  | B    | r <sub>1,2</sub> |        |                        |
| mm         |    |      |                  | kg     | -                      |
| 14         | 17 | 17   | 0,3              | 0,01   | <b>IR 14×17×17</b>     |
| 15         | 18 | 12,5 | 0,3              | 0,0072 | <b>LR 15×18×12,5</b>   |
|            | 18 | 16   | 0,3              | 0,0096 | <b>IR 15×18×16</b>     |
|            | 18 | 16,5 | 0,3              | 0,0099 | <b>IR 15×18×16,5</b>   |
|            | 18 | 16,5 | 0,3              | 0,0099 | <b>LR 15×18×16,5</b>   |
|            | 19 | 16   | 0,3              | 0,013  | <b>IR 15×19×16</b>     |
|            | 19 | 20   | 0,3              | 0,016  | <b>IR 15×19×20</b>     |
|            | 20 | 12   | 0,3              | 0,012  | <b>IR 15×20×12 IS1</b> |
| 17         | 20 | 13   | 0,3              | 0,014  | <b>IR 15×20×13</b>     |
|            | 20 | 23   | 0,3              | 0,024  | <b>IR 15×20×23</b>     |
|            | 20 | 16   | 0,3              | 0,011  | <b>IR 17×20×16</b>     |
|            | 20 | 16,5 | 0,3              | 0,011  | <b>IR 17×20×16,5</b>   |
|            | 20 | 16,5 | 0,3              | 0,011  | <b>LR 17×20×16,5</b>   |
|            | 20 | 20   | 0,3              | 0,014  | <b>IR 17×20×20</b>     |
|            | 20 | 20,5 | 0,3              | 0,014  | <b>IR 17×20×20,5</b>   |
|            | 20 | 20,5 | 0,3              | 0,014  | <b>LR 17×20×20,5</b>   |
|            | 20 | 30,5 | 0,3              | 0,021  | <b>IR 17×20×30,5</b>   |
|            | 20 | 30,5 | 0,3              | 0,021  | <b>LR 17×20×30,5</b>   |
|            | 21 | 16   | 0,3              | 0,014  | <b>IR 17×21×16</b>     |
| 20         | 21 | 20   | 0,3              | 0,018  | <b>IR 17×21×20</b>     |
|            | 22 | 13   | 0,3              | 0,015  | <b>IR 17×22×13</b>     |
|            | 22 | 16   | 0,3              | 0,019  | <b>IR 17×22×16</b>     |
|            | 22 | 23   | 0,3              | 0,027  | <b>IR 17×22×23</b>     |
|            | 24 | 20   | 0,3              | 0,034  | <b>IR 17×24×20</b>     |
|            | 24 | 16   | 0,3              | 0,017  | <b>IR 20×24×16</b>     |
| 20         | 24 | 20   | 0,3              | 0,021  | <b>IR 20×24×20</b>     |
|            | 25 | 12,5 | 0,3              | 0,016  | <b>LR 20×25×12,5</b>   |
|            | 25 | 16   | 0,3              | 0,021  | <b>IR 20×25×16 IS1</b> |
|            | 25 | 16,5 | 0,3              | 0,022  | <b>LR 20×25×16,5</b>   |
|            | 25 | 17   | 0,3              | 0,022  | <b>IR 20×25×17</b>     |
|            | 25 | 20   | 0,3              | 0,028  | <b>IR 20×25×20</b>     |
|            | 25 | 20,5 | 0,3              | 0,028  | <b>IR 20×25×20,5</b>   |
|            | 25 | 20,5 | 0,3              | 0,028  | <b>LR 20×25×20,5</b>   |
|            | 25 | 26,5 | 0,3              | 0,036  | <b>IR 20×25×26,5</b>   |
|            | 25 | 26,5 | 0,3              | 0,036  | <b>LR 20×25×26,5</b>   |
|            | 25 | 30   | 0,3              | 0,041  | <b>IR 20×25×30</b>     |
|            | 25 | 38,5 | 0,3              | 0,053  | <b>IR 20×25×38,5</b>   |
|            | 25 | 38,5 | 0,3              | 0,053  | <b>LR 20×25×38,5</b>   |
|            | 28 | 20   | 0,6              | 0,045  | <b>IR 20×28×20</b>     |

| Dimensions |      |      |                     | Mass          | Designation     |
|------------|------|------|---------------------|---------------|-----------------|
| d          | F    | B    | r, r <sub>1,2</sub> |               |                 |
| mm         |      |      |                     | kg            | –               |
| 22         | 26   | 16   | 0,3                 | 0,018         | IR 22×26×16     |
|            | 26   | 20   | 0,3                 | 0,023         | IR 22×26×20     |
|            | 28   | 17   | 0,3                 | 0,03          | IR 22×28×17     |
|            | 28   | 20   | 0,3                 | 0,035         | IR 22×28×20     |
|            | 28   | 20,5 | 0,3                 | 0,036         | IR 22×28×20.5   |
|            | 28   | 20,5 | 0,3                 | 0,036         | LR 22×28×20.5   |
|            | 28   | 30   | 0,3                 | 0,054         | IR 22×28×30     |
| 25         | 29   | 20   | 0,3                 | 0,026         | IR 25×29×20     |
|            | 29   | 30   | 0,3                 | 0,039         | IR 25×29×30     |
|            | 30   | 12,5 | 0,3                 | 0,02          | LR 25×30×12.5   |
|            | 30   | 16   | 0,3                 | 0,026         | IR 25×30×16 IS1 |
|            | 30   | 16,5 | 0,3                 | 0,027         | LR 25×30×16.5   |
|            | 30   | 17   | 0,3                 | 0,028         | IR 25×30×17     |
|            | 30   | 20   | 0,3                 | 0,033         | IR 25×30×20     |
|            | 30   | 20,5 | 0,3                 | 0,034         | IR 25×30×20.5   |
|            | 30   | 20,5 | 0,3                 | 0,034         | LR 25×30×20.5   |
|            | 30   | 26,5 | 0,3                 | 0,043         | IR 25×30×26.5   |
|            | 30   | 26,5 | 0,3                 | 0,043         | LR 25×30×26.5   |
|            | 30   | 30   | 0,3                 | 0,05          | IR 25×30×30     |
|            | 30   | 32   | 0,3                 | 0,053         | IR 25×30×32     |
|            | 30   | 38,5 | 0,3                 | 0,064         | IR 25×30×38.5   |
| 30         | 38,5 | 0,3  | 0,064               | LR 25×30×38.5 |                 |
| 32         | 22   | 0,6  | 0,052               | IR 25×32×22   |                 |
| 28         | 32   | 17   | 0,3                 | 0,025         | IR 28×32×17     |
|            | 32   | 20   | 0,3                 | 0,028         | IR 28×32×20     |
|            | 32   | 30   | 0,3                 | 0,044         | IR 28×32×30     |
| 30         | 35   | 12,5 | 0,3                 | 0,023         | LR 30×35×12.5   |
|            | 35   | 13   | 0,3                 | 0,025         | IR 30×35×13     |
|            | 35   | 16   | 0,3                 | 0,031         | IR 30×35×16     |
|            | 35   | 16,5 | 0,3                 | 0,031         | LR 30×35×16.5   |
|            | 35   | 17   | 0,3                 | 0,032         | IR 30×35×17     |
|            | 35   | 20   | 0,3                 | 0,04          | IR 30×35×20     |
|            | 35   | 20,5 | 0,3                 | 0,041         | IR 30×35×20.5   |
|            | 35   | 20,5 | 0,3                 | 0,041         | LR 30×35×20.5   |
|            | 35   | 26   | 0,3                 | 0,05          | IR 30×35×26     |
|            | 35   | 30   | 0,3                 | 0,059         | IR 30×35×30     |
|            | 37   | 18   | 0,6                 | 0,05          | IR 30×37×18     |
|            | 37   | 22   | 0,6                 | 0,061         | IR 30×37×22     |
|            | 38   | 20   | 0,6                 | 0,065         | IR 30×38×20 IS1 |

| Dimensions |    |      |                     | Mass  | Designation     |
|------------|----|------|---------------------|-------|-----------------|
| d          | F  | B    | r, r <sub>1,2</sub> |       |                 |
| mm         |    |      |                     | kg    | –               |
| 32         | 37 | 20   | 0,3                 | 0,042 | IR 32×37×20     |
|            | 37 | 30   | 0,3                 | 0,063 | IR 32×37×30     |
|            | 40 | 20   | 0,6                 | 0,068 | IR 32×40×20     |
|            | 40 | 36   | 0,6                 | 0,12  | IR 32×40×36     |
| 33         | 37 | 13   | 0,3                 | 0,022 | IR 33×37×13     |
| 35         | 40 | 12,5 | 0,3                 | 0,027 | LR 35×40×12.5   |
|            | 40 | 16,5 | 0,3                 | 0,037 | LR 35×40×16.5   |
|            | 40 | 17   | 0,3                 | 0,038 | IR 35×40×17     |
|            | 40 | 20   | 0,3                 | 0,044 | IR 35×40×20     |
|            | 40 | 20,5 | 0,3                 | 0,046 | IR 35×40×20.5   |
|            | 40 | 20,5 | 0,3                 | 0,046 | LR 35×40×20.5   |
|            | 40 | 30   | 0,3                 | 0,068 | IR 35×40×30     |
|            | 42 | 20   | 0,6                 | 0,064 | IR 35×42×20 IS1 |
| 38         | 42 | 36   | 0,6                 | 0,12  | IR 35×42×36     |
|            | 43 | 22   | 0,6                 | 0,082 | IR 35×43×22     |
| 38         | 43 | 20   | 0,3                 | 0,048 | IR 38×43×20     |
|            | 43 | 30   | 0,3                 | 0,074 | IR 38×43×30     |
| 40         | 45 | 16,5 | 0,3                 | 0,041 | LR 40×45×16.5   |
|            | 45 | 17   | 0,3                 | 0,043 | IR 40×45×17     |
|            | 45 | 20   | 0,3                 | 0,051 | IR 40×45×20     |
|            | 45 | 20,5 | 0,3                 | 0,053 | IR 40×45×20.5   |
|            | 45 | 20,5 | 0,3                 | 0,053 | LR 40×45×20.5   |
|            | 45 | 30   | 0,3                 | 0,077 | IR 40×45×30     |
|            | 48 | 22   | 0,6                 | 0,092 | IR 40×48×22     |
| 42         | 48 | 40   | 0,6                 | 0,17  | IR 40×48×40     |
|            | 50 | 20   | 1                   | 0,11  | IR 40×50×20 IS1 |
|            | 50 | 22   | 1                   | 0,12  | IR 40×50×22     |
| 42         | 47 | 20   | 0,3                 | 0,054 | IR 42×47×20     |
|            | 47 | 30   | 0,3                 | 0,081 | IR 42×47×30     |

# Needle roller bearing inner rings

## d 45 – 380 mm

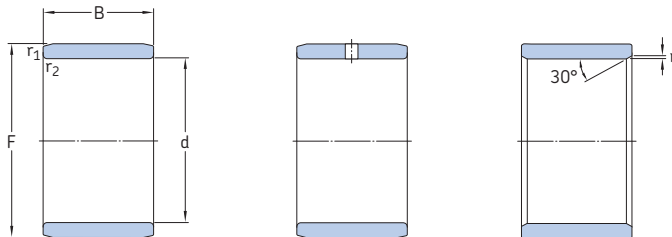

IR

IR .. IS1

LR

| Dimensions |    |      |                     | Mass  | Designation     |
|------------|----|------|---------------------|-------|-----------------|
| d          | F  | B    | r, r <sub>1,2</sub> |       |                 |
| mm         |    |      |                     | kg    | -               |
| 45         | 50 | 20,5 | 0,3                 | 0,058 | LR 45×50×20,5   |
|            | 50 | 25   | 0,6                 | 0,071 | IR 45×50×25     |
|            | 50 | 25,5 | 0,3                 | 0,074 | IR 45×50×25,5   |
|            | 50 | 25,5 | 0,3                 | 0,074 | LR 45×50×25,5   |
|            | 50 | 35   | 0,6                 | 0,1   | IR 45×50×35     |
|            | 52 | 22   | 0,6                 | 0,089 | IR 45×52×22     |
|            | 52 | 40   | 0,6                 | 0,16  | IR 45×52×40     |
|            | 55 | 20   | 1                   | 0,12  | IR 45×55×20 IS1 |
|            | 55 | 22   | 1                   | 0,13  | IR 45×55×22     |
| 50         | 55 | 20   | 0,6                 | 0,063 | IR 50×55×20 IS1 |
|            | 55 | 20,5 | 0,6                 | 0,064 | LR 50×55×20,5   |
|            | 55 | 25   | 0,6                 | 0,078 | IR 50×55×25     |
|            | 55 | 35   | 0,6                 | 0,11  | IR 50×55×35     |
|            | 58 | 22   | 0,6                 | 0,12  | IR 50×58×22     |
|            | 58 | 40   | 0,6                 | 0,21  | IR 50×58×40     |
|            | 60 | 20   | 1                   | 0,13  | IR 50×60×20 IS1 |
|            | 60 | 25   | 1                   | 0,16  | IR 50×60×25     |
|            | 60 | 28   | 1                   | 0,18  | IR 50×60×28     |
| 55         | 60 | 25   | 0,6                 | 0,086 | IR 55×60×25     |
|            | 60 | 35   | 0,6                 | 0,12  | IR 55×60×35     |
|            | 63 | 25   | 1                   | 0,14  | IR 55×63×25     |
|            | 63 | 45   | 1                   | 0,26  | IR 55×63×45     |
|            | 65 | 28   | 1,1                 | 0,2   | IR 55×65×28     |
| 60         | 68 | 25   | 1                   | 0,15  | IR 60×68×25     |
|            | 68 | 35   | 0,6                 | 0,21  | IR 60×68×35     |
|            | 68 | 45   | 1                   | 0,28  | IR 60×68×45     |
|            | 70 | 25   | 1                   | 0,2   | IR 60×70×25     |
|            | 70 | 28   | 1,1                 | 0,22  | IR 60×70×28     |
| 65         | 72 | 25   | 1                   | 0,14  | IR 65×72×25     |
|            | 72 | 45   | 1                   | 0,26  | IR 65×72×45     |
|            | 73 | 25   | 1                   | 0,16  | IR 65×73×25     |
|            | 73 | 35   | 1                   | 0,23  | IR 65×73×35     |
|            | 75 | 28   | 1,1                 | 0,23  | IR 65×75×28     |
| 70         | 80 | 25   | 1                   | 0,22  | IR 70×80×25     |
|            | 80 | 30   | 1                   | 0,27  | IR 70×80×30     |
|            | 80 | 35   | 1                   | 0,31  | IR 70×80×35     |
|            | 80 | 54   | 1                   | 0,49  | IR 70×80×54     |

| Dimensions |     |    |                     | Mass | Designation   |
|------------|-----|----|---------------------|------|---------------|
| d          | F   | B  | r, r <sub>1,2</sub> |      |               |
| mm         |     |    |                     | kg   | -             |
| 75         | 85  | 25 | 1                   | 0,24 | IR 75×85×25   |
|            | 85  | 30 | 1                   | 0,29 | IR 75×85×30   |
|            | 85  | 35 | 1                   | 0,34 | IR 75×85×35   |
|            | 85  | 54 | 1                   | 0,52 | IR 75×85×54   |
|            | 80  | 90 | 25                  | 1    | 0,25          |
| 90         |     | 30 | 1                   | 0,3  | IR 80×90×30   |
| 90         |     | 35 | 1                   | 0,36 | IR 80×90×35   |
| 90         |     | 54 | 1                   | 0,55 | IR 80×90×54   |
| 85         | 95  | 26 | 1                   | 0,28 | IR 85×95×26   |
|            | 95  | 36 | 1                   | 0,39 | IR 85×95×36   |
|            | 100 | 35 | 1,1                 | 0,58 | IR 85×100×35  |
|            | 100 | 63 | 1,1                 | 1,05 | IR 85×100×63  |
| 90         | 100 | 26 | 1                   | 0,29 | IR 90×100×26  |
|            | 100 | 30 | 1                   | 0,34 | IR 90×100×30  |
|            | 100 | 36 | 1                   | 0,41 | IR 90×100×36  |
|            | 105 | 35 | 1,1                 | 0,61 | IR 90×105×35  |
|            | 105 | 63 | 1,1                 | 1,1  | IR 90×105×63  |
| 95         | 105 | 26 | 1                   | 0,31 | IR 95×105×26  |
|            | 105 | 36 | 1                   | 0,43 | IR 95×105×36  |
|            | 110 | 35 | 1,1                 | 0,64 | IR 95×110×35  |
|            | 110 | 63 | 1,1                 | 1,15 | IR 95×110×63  |
| 100        | 110 | 30 | 1,1                 | 0,37 | IR 100×110×30 |
|            | 110 | 40 | 1,1                 | 0,51 | IR 100×110×40 |
|            | 115 | 40 | 1,1                 | 0,78 | IR 100×115×40 |
| 110        | 120 | 30 | 1                   | 0,41 | IR 110×120×30 |
|            | 125 | 40 | 1,1                 | 0,84 | IR 110×125×40 |
| 120        | 130 | 30 | 1                   | 0,44 | IR 120×130×30 |
|            | 135 | 45 | 1,1                 | 1    | IR 120×135×45 |
| 130        | 145 | 35 | 1,1                 | 0,86 | IR 130×145×35 |
|            | 150 | 50 | 1,5                 | 1,7  | IR 130×150×50 |
| 140        | 155 | 35 | 1,1                 | 0,92 | IR 140×155×35 |
|            | 160 | 50 | 1,5                 | 1,8  | IR 140×160×50 |

| Dimensions |     |     | Mass                |      | Designation           |
|------------|-----|-----|---------------------|------|-----------------------|
| d          | F   | B   | r, r <sub>1,2</sub> |      |                       |
| mm         |     |     | kg                  |      | –                     |
| <b>150</b> | 165 | 40  | 1,1                 | 1,1  | <b>IR 150×165×40</b>  |
| <b>160</b> | 175 | 40  | 1,1                 | 1,2  | <b>IR 160×175×40</b>  |
| <b>170</b> | 185 | 45  | 1,1                 | 1,45 | <b>IR 170×185×45</b>  |
| <b>180</b> | 195 | 45  | 1,1                 | 1,5  | <b>IR 180×195×45</b>  |
| <b>190</b> | 210 | 50  | 1,5                 | 2,4  | <b>IR 190×210×50</b>  |
| <b>200</b> | 220 | 50  | 1,5                 | 2,5  | <b>IR 200×220×50</b>  |
| <b>220</b> | 240 | 50  | 1,5                 | 2,75 | <b>IR 220×240×50</b>  |
| <b>240</b> | 265 | 60  | 2                   | 4,6  | <b>IR 240×265×60</b>  |
| <b>260</b> | 285 | 60  | 2                   | 5    | <b>IR 260×285×60</b>  |
| <b>280</b> | 305 | 69  | 2                   | 6,1  | <b>IR 280×305×69</b>  |
| <b>300</b> | 330 | 80  | 2,1                 | 9,2  | <b>IR 300×330×80</b>  |
| <b>320</b> | 350 | 80  | 2,1                 | 9,8  | <b>IR 320×350×80</b>  |
| <b>340</b> | 370 | 80  | 2,1                 | 10   | <b>IR 340×370×80</b>  |
| <b>360</b> | 390 | 80  | 2,1                 | 11   | <b>IR 360×390×80</b>  |
| <b>380</b> | 415 | 100 | 2,1                 | 17   | <b>IR 380×415×100</b> |

## Needle rollers

Needle rollers can be used to make full complement bearing arrangements for slow speed or oscillating applications. These compact bearing arrangements have a high load carrying capacity and are economical, provided the shaft and housing bore can serve as raceways. The cylindrical surface of the rollers is slightly relieved toward the roller ends to prevent damaging edge stresses.

For additional information about surface requirements for raceways, refer to the section *Raceways on shafts and in housings*, starting on **page 50**. For assistance in designing full complement bearing arrangements or to calculate performance data for these bearing arrangements, contact the SKF application engineering service.

### Materials

SKF needle rollers are made from carbon chromium steel with a hardness of 58 to 65 HRC and have a precision machined surface.

### Tolerances

SKF needle rollers are in accordance with ISO 3096:1996 Grade 2 for flat end needle rollers. SKF supplies needle rollers with the dimensional and form tolerances as listed in **table 3**, where the preferred diameter deviations range from 0 to  $-7 \mu\text{m}$ .

The rollers are gauged according to their minimum and maximum deviation from the nominal diameter.

Needle rollers for each gauge are packed separately and the package is marked with the gauge limits, e.g. N/M2 or M2/M4, where M signifies minus and N zero. For a needle roller with a 2 mm nominal diameter and gauge limits M2/M4, the actual diameter is between 1,998 mm and 1,996 mm.

### Note

Needle rollers of the same gauge should be used in each bearing arrangement.

A delivery of needle rollers of the same nominal diameter may contain packages of one or more gauges, depending on availability at the time.

Table 3

Dimensional and form accuracy of SKF needle rollers, grade G2

| Diameter $D_w$<br>Deviation |     | Gauge<br>tolerance | Gauge<br>limits                                                               | Roundness<br>(max circularity<br>deviation in accordance<br>with ISO 3096) | Length $L_w$<br>Tolerance class |
|-----------------------------|-----|--------------------|-------------------------------------------------------------------------------|----------------------------------------------------------------------------|---------------------------------|
| high                        | low |                    |                                                                               |                                                                            |                                 |
| $\mu\text{m}$               |     |                    |                                                                               |                                                                            | –                               |
| 0                           | -10 | 2                  | 0/-2<br>-1/-3<br>-2/-4<br>-3/-5<br>-4/-6<br>-5/-7<br>-6/-8<br>-7/-9<br>-8/-10 | 1                                                                          | h13                             |

## Supplementary designations

The designation suffixes used to identify certain features of SKF needle rollers are explained in the following.

- BF** Needle roller with flat ends
- G2** Needle roller in accordance with ISO 3096:1996 Grade 2
- M../M..** Diameter tolerance of needle rollers, e.g. M2/M4 indicates diameter tolerance  $-2$  to  $-4$   $\mu\text{m}$
- N/M..** Diameter tolerance of needle rollers, e.g. N/M2 indicates diameter tolerance  $0$  to  $-2$   $\mu\text{m}$

## Needle rollers

$D_w$  1 – 6 mm

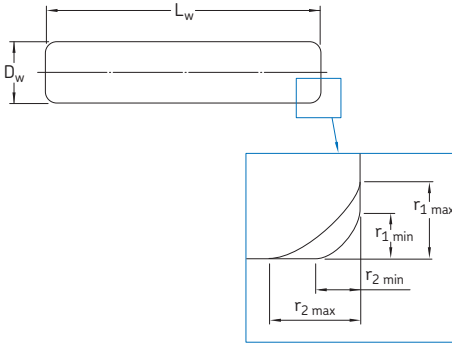

| Dimensions |       |                |            |            | Mass     | Designation       |
|------------|-------|----------------|------------|------------|----------|-------------------|
| $D_w$      | $L_w$ | $r_{1,2} \min$ | $r_1 \max$ | $r_2 \max$ | per 1000 |                   |
| mm         |       |                |            |            | kg       | –                 |
| 1          | 7,8   | 0,1            | 0,4        | 0,6        | 0,048    | RN-1x7.8 BF/G2    |
| 1,5        | 5,8   | 0,1            | 0,4        | 0,6        | 0,081    | RN-1.5x5.8 BF/G2  |
|            | 6,8   | 0,1            | 0,4        | 0,6        | 0,094    | RN-1.5x6.8 BF/G2  |
|            | 7,8   | 0,1            | 0,4        | 0,6        | 0,108    | RN-1.5x7.8 BF/G2  |
|            | 9,8   | 0,1            | 0,4        | 0,6        | 0,136    | RN-1.5x9.8 BF/G2  |
|            | 11,8  | 0,1            | 0,4        | 0,6        | 0,164    | RN-1.5x11.8 BF/G2 |
|            | 13,8  | 0,1            | 0,4        | 0,6        | 0,191    | RN-1.5x13.8 BF/G2 |
| 2          | 6,3   | 0,2            | 0,6        | 0,8        | 0,16     | RN-2x6.3 BF/G2    |
|            | 7,8   | 0,2            | 0,6        | 0,8        | 0,19     | RN-2x7.8 BF/G2    |
|            | 9,8   | 0,2            | 0,6        | 0,8        | 0,24     | RN-2x9.8 BF/G2    |
|            | 11,8  | 0,2            | 0,6        | 0,8        | 0,29     | RN-2x11.8 BF/G2   |
|            | 13,8  | 0,2            | 0,6        | 0,8        | 0,34     | RN-2x13.8 BF/G2   |
|            | 15,8  | 0,2            | 0,6        | 0,8        | 0,39     | RN-2x15.8 BF/G2   |
|            | 17,8  | 0,2            | 0,6        | 0,8        | 0,44     | RN-2x17.8 BF/G2   |
|            | 19,8  | 0,2            | 0,6        | 0,8        | 0,49     | RN-2x19.8 BF/G2   |
|            | 21,8  | 0,2            | 0,6        | 0,8        | 0,54     | RN-2x21.8 BF/G2   |
|            | 2,5   | 7,8            | 0,2        | 0,6        | 0,8      | 0,3               |
| 9,8        |       | 0,2            | 0,6        | 0,8        | 0,38     | RN-2.5x9.8 BF/G2  |
| 11,8       |       | 0,2            | 0,6        | 0,8        | 0,45     | RN-2.5x11.8 BF/G2 |
| 13,8       |       | 0,2            | 0,6        | 0,8        | 0,53     | RN-2.5x13.8 BF/G2 |
| 15,8       |       | 0,2            | 0,6        | 0,8        | 0,61     | RN-2.5x15.8 BF/G2 |
| 17,8       |       | 0,2            | 0,6        | 0,8        | 0,69     | RN-2.5x17.8 BF/G2 |
| 19,8       |       | 0,2            | 0,6        | 0,8        | 0,76     | RN-2.5x19.8 BF/G2 |
| 21,8       |       | 0,2            | 0,6        | 0,8        | 0,84     | RN-2.5x21.8 BF/G2 |
| 3          | 9,8   | 0,2            | 0,6        | 0,8        | 0,54     | RN-3x9.8 BF/G2    |
|            | 11,8  | 0,2            | 0,6        | 0,8        | 0,65     | RN-3x11.8 BF/G2   |
|            | 13,8  | 0,2            | 0,6        | 0,8        | 0,77     | RN-3x13.8 BF/G2   |
|            | 15,8  | 0,2            | 0,6        | 0,8        | 0,88     | RN-3x15.8 BF/G2   |
|            | 17,8  | 0,2            | 0,6        | 0,8        | 0,99     | RN-3x17.8 BF/G2   |
|            | 19,8  | 0,2            | 0,6        | 0,8        | 1,1      | RN-3x19.8 BF/G2   |
|            | 21,8  | 0,2            | 0,6        | 0,8        | 1,21     | RN-3x21.8 BF/G2   |
|            | 23,8  | 0,2            | 0,6        | 0,8        | 1,32     | RN-3x23.8 BF/G2   |



| Dimensions     |                |                         |                       |                       | Mass<br>per 1000 | Designation       |
|----------------|----------------|-------------------------|-----------------------|-----------------------|------------------|-------------------|
| D <sub>w</sub> | L <sub>w</sub> | r <sub>1,2</sub><br>min | r <sub>1</sub><br>max | r <sub>2</sub><br>max |                  |                   |
| mm             |                |                         |                       |                       | kg               | –                 |
| 3,5            | 11,8           | 0,3                     | 0,8                   | 1                     | 0,89             | RN-3.5×11.8 BF/G2 |
|                | 13,8           | 0,3                     | 0,8                   | 1                     | 1,04             | RN-3.5×13.8 BF/G2 |
|                | 15,8           | 0,3                     | 0,8                   | 1                     | 1,19             | RN-3.5×15.8 BF/G2 |
|                | 17,8           | 0,3                     | 0,8                   | 1                     | 1,34             | RN-3.5×17.8 BF/G2 |
|                | 19,8           | 0,3                     | 0,8                   | 1                     | 1,5              | RN-3.5×19.8 BF/G2 |
|                | 21,8           | 0,3                     | 0,8                   | 1                     | 1,65             | RN-3.5×21.8 BF/G2 |
|                | 29,8           | 0,3                     | 0,8                   | 1                     | 2,25             | RN-3.5×29.8 BF/G2 |
|                | 34,8           | 0,3                     | 0,8                   | 1                     | 2,63             | RN-3.5×34.8 BF/G2 |
|                | 4              | 11,8                    | 0,3                   | 0,8                   | 1                | 1,16              |
| 13,8           |                | 0,3                     | 0,8                   | 1                     | 1,36             | RN-4×13.8 BF/G2   |
| 15,8           |                | 0,3                     | 0,8                   | 1                     | 1,56             | RN-4×15.8 BF/G2   |
| 17,8           |                | 0,3                     | 0,8                   | 1                     | 1,76             | RN-4×17.8 BF/G2   |
| 19,8           |                | 0,3                     | 0,8                   | 1                     | 1,95             | RN-4×19.8 BF/G2   |
| 21,8           |                | 0,3                     | 0,8                   | 1                     | 2,15             | RN-4×21.8 BF/G2   |
| 23,8           |                | 0,3                     | 0,8                   | 1                     | 2,35             | RN-4×23.8 BF/G2   |
| 25,8           |                | 0,3                     | 0,8                   | 1                     | 2,55             | RN-4×25.8 BF/G2   |
| 27,8           |                | 0,3                     | 0,8                   | 1                     | 2,74             | RN-4×27.8 BF/G2   |
| 29,8           |                | 0,3                     | 0,8                   | 1                     | 2,94             | RN-4×29.8 BF/G2   |
| 34,8           |                | 0,3                     | 0,8                   | 1                     | 3,43             | RN-4×34.8 BF/G2   |
| 39,8           |                | 0,3                     | 0,8                   | 1                     | 3,93             | RN-4×39.8 BF/G2   |
| 5              | 15,8           | 0,3                     | 0,8                   | 1                     | 2,44             | RN-5×15.8 BF/G2   |
|                | 19,8           | 0,3                     | 0,8                   | 1                     | 3,05             | RN-5×19.8 BF/G2   |
|                | 21,8           | 0,3                     | 0,8                   | 1                     | 3,36             | RN-5×21.8 BF/G2   |
|                | 23,8           | 0,3                     | 0,8                   | 1                     | 3,67             | RN-5×23.8 BF/G2   |
|                | 25,8           | 0,3                     | 0,8                   | 1                     | 3,98             | RN-5×25.8 BF/G2   |
|                | 27,8           | 0,3                     | 0,8                   | 1                     | 4,28             | RN-5×27.8 BF/G2   |
|                | 29,8           | 0,3                     | 0,8                   | 1                     | 4,59             | RN-5×29.8 BF/G2   |
|                | 34,8           | 0,3                     | 0,8                   | 1                     | 5,36             | RN-5×34.8 BF/G2   |
|                | 39,8           | 0,3                     | 0,8                   | 1                     | 6,13             | RN-5×39.8 BF/G2   |
| 6              | 17,8           | 0,3                     | 0,8                   | 1                     | 3,95             | RN-6×17.8 BF/G2   |

## Radial shaft seals with a low cross sectional height

It is not always easy to find commercially available radial shaft seals for bearing arrangements that incorporate needle roller bearings because of their very low cross section. As a result, SKF offers a wide assortment of special low cross section radial shaft seals to fit virtually all of these bearing arrangements. These contact seals are designed without garter springs and available in two designs:

- the G design with a single lip
- the SD design with a double lip

### G design radial shaft seals

G design radial shaft seals are made of acrylonitrile-butadiene rubber (NBR). The seals for shaft diameters  $\geq 8$  mm ( $\rightarrow$  fig. 5) are reinforced with sheet steel. The rubber outside diameter enhances the seal around the housing bore and reduces the risk of damage to the seal and housing during installation and removal.

To attain an adequate degree of rigidity for seals for shaft diameters  $\leq 7$  mm ( $\rightarrow$  fig. 6), the rubber material is metal cased. These seals are identified by the designation suffix S.

If the seal is to be used primarily for lubricant retention, it should be mounted with the lip facing inward. If the primary purpose of the seal is to exclude contaminants, the lip should face outward, away from the bearing ( $\rightarrow$  fig. 7).

For information about the chemical resistance of acrylonitrile-butadiene rubber (NBR), refer to the *SKF Interactive Engineering Catalogue* (section *Chemical resistance*).

### SD design radial shaft seals

SD design radial shaft seals ( $\rightarrow$  fig. 8) have a primary seal lip and an auxiliary dust lip. The lips are made of polyurethane (AU) and the reinforcement ring is made of polyamide (PA) instead of metal.

The auxiliary lip is the smaller of the two lips and designed with zero lip/shaft interference to avoid additional friction, heat and energy losses.

The primary seal lip, i.e. the larger of the two lips, is a contact seal and should always point toward the medium that is to be sealed. Therefore, if the primary function is protection

Fig. 5

Radial shaft seal

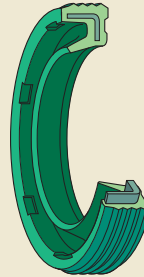

G series ( $d_1 \geq 8$  mm)

Fig. 6

Radial shaft seal

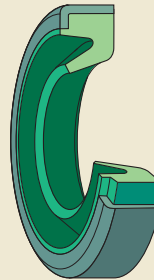

G.. S series ( $d_1 \leq 7$  mm)

Fig. 7

Needle roller bearing with machined rings with an external G design seal

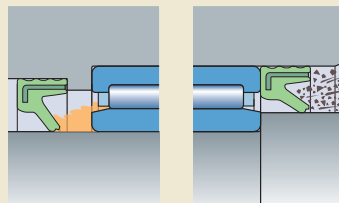

Primary lip facing inward

Primary lip facing outward

against ingress of contaminants, the primary lip should face outward. The auxiliary lip will contribute to retain lubricant in the bearing arrangement.

In applications whereas the main purpose is retaining the lubricant, the primary lip should face inward, toward the bearing.

The cavity between the two lips should be filled with a grease that is compatible with the lubricant used in the application. This will provide additional protection and prevent the seal from dry running.

SD seals are resistant to lubricating oils, even those containing small quantities of EP additives, and also to mineral oil based greases.

Depending on the counterface of the shaft, SD seals can also be used as wiper seals for linear applications with speeds up to 3 m/s.

## Design of associated components

### Shaft requirements

To achieve a reliable seal and sufficiently long service life, the surface of the seal counterface should have a hardness of at least 55 HRC or 600 HV. The surface roughness of the counterface on the shaft of rotary applications should lie between  $R_a$  0,2 and 0,8  $\mu\text{m}$ , if the maximum permissible circumferential speeds are to be used. For linear applications, the maximum permissible roughness of the counterface is  $R_a$  0,3  $\mu\text{m}$ .

The diameter of the shaft at the counterface should be machined to g7 up to k7 tolerance classes. The shaft end should have a 15 to 30° lead-in chamfer to prevent damage to the seal lips during mounting. Appropriate minimum dimensions for lead-in chamfers ( $\rightarrow$  fig. 9) are:

- $h_1 = 0,3$  mm for seals with an outside diameter  $d_2 \leq 30$  mm
- $h_1 = 0,5$  mm for seals with an outside diameter  $d_2 > 30$  mm

### Housing requirements

The housing bore tolerance classes normally recommended for needle roller bearings will provide a sufficient interference fit for the seals.

In general, these seals can be fitted into housing bores machined to G7 up to R7 tolerance class.

Fig. 8

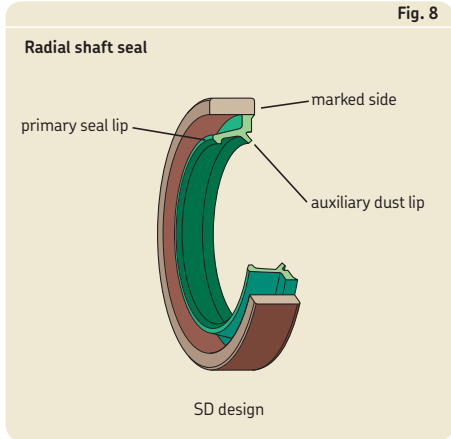
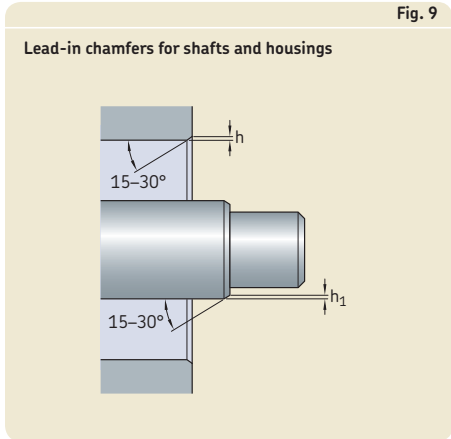

Fig. 9



No additional axial location of the seal will be needed.

To simplify mounting, the housing bore should have a 15 to 30° lead-in chamfer. Appropriate minimum dimensions for lead-in chamfers ( $\rightarrow$  fig. 9) are:

- $h = 0,3$  mm for seals with an outside diameter  $d_2 \leq 30$  mm
- $h = 0,01 d_2$  mm for seals with an outside diameter  $d_2 > 30$  mm

## Radial shaft seals with a low cross sectional height

### Speeds

If the recommendations under *Design of associated components* are adhered to, the permissible circumferential speed is 10 m/s for both seal designs. To convert circumferential speed to rotational speed, use

$$n = \frac{d \pi 1\,000}{v 60}$$

where

n = rotational speed [r/min]

d = shaft diameter [mm]

v = circumferential speed [m/s]

### Operating temperature range

The permissible operating temperature range for

- G design seals is  $-30$  to  $+110$  °C  
( $-20$  to  $+230$  °F)
- SD design seals is  $-30$  to  $+100$  °C  
( $-20$  to  $+210$  °F).

These material related temperature ranges can only be considered as rough guidelines as the influence from the medium in which the seal is working must also be considered.

### Mounting instructions

The seals should be mounted concentric and perpendicular to the shaft. A suitable mounting tool (→ **fig. 10**) should be used to prevent the seal from skewing. The outside diameter of G design seals should be lightly oiled to ease installation. If the shaft ends are not chamfered or rounded, a mounting sleeve should be used to prevent damage to the seal lip.

Fig. 10

Mounting tool

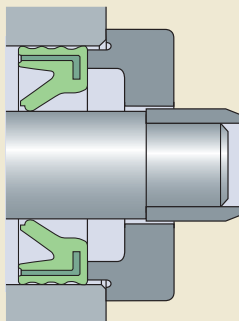



Radial shaft seals with a low cross sectional height  
 $d_4 - 70$  mm

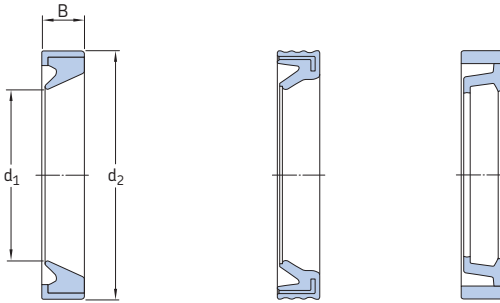

G  
 $(d_1 \leq 7 \text{ mm})$

G  
 $(d_1 \geq 8 \text{ mm})$

SD

| Dimensions |       |   | Mass per 100 | Designation | Dimensions |       |   | Mass per 100 | Designation |
|------------|-------|---|--------------|-------------|------------|-------|---|--------------|-------------|
| $d_1$      | $d_2$ | b |              |             | $d_1$      | $d_2$ | b |              |             |
| mm         |       |   | kg           | –           | mm         |       |   | kg           | –           |
| 4          | 8     | 2 | 0,018        | G 4×8×2 S   | 16         | 22    | 3 | 0,13         | G 16×22×3   |
| 5          | 9     | 2 | 0,019        | G 5×9×2 S   |            | 22    | 3 | 0,06         | SD 16×22×3  |
|            | 10    | 2 | 0,022        | G 5×10×2 S  |            | 24    | 3 | 0,13         | G 16×24×3   |
| 6          | 10    | 2 | 0,021        | G 6×10×2 S  |            | 24    | 3 | 0,08         | SD 16×24×3  |
|            | 12    | 2 | 0,038        | G 6×12×2 S  |            | 25    | 3 | 0,16         | G 16×25×3   |
| 7          | 11    | 2 | 0,025        | G 7×11×2 S  | 17         | 23    | 3 | 0,13         | G 17×23×3   |
|            | 14    | 2 | 0,052        | G 7×14×2 S  |            | 23    | 3 | 0,06         | SD 17×23×3  |
| 8          | 12    | 3 | 0,041        | G 8×12×3    |            | 25    | 3 | 0,15         | G 17×25×3   |
|            | 15    | 3 | 0,065        | G 8×15×3    |            | 25    | 3 | 0,08         | SD 17×25×3  |
|            | 15    | 3 | 0,04         | SD 8×15×3   | 18         | 24    | 3 | 0,12         | G 18×24×3   |
| 9          | 13    | 3 | 0,044        | G 9×13×3    |            | 24    | 3 | 0,06         | SD 18×24×3  |
|            | 16    | 3 | 0,069        | G 9×16×3    |            | 26    | 4 | 0,18         | G 18×26×4   |
|            |       |   |              |             |            | 26    | 4 | 0,11         | SD 18×26×4  |
| 10         | 14    | 3 | 0,05         | G 10×14×3   | 19         | 27    | 4 | 0,2          | G 19×27×4   |
|            | 17    | 3 | 0,09         | G 10×17×3   |            | 27    | 4 | 0,11         | SD 19×27×4  |
|            | 17    | 3 | 0,044        | SD 10×17×3  | 20         | 26    | 4 | 0,18         | G 20×26×4   |
| 12         | 16    | 3 | 0,06         | G 12×16×3   |            | 26    | 4 | 0,08         | SD 20×26×4  |
|            | 18    | 3 | 0,09         | G 12×18×3   |            | 28    | 4 | 0,21         | G 20×28×4   |
|            | 18    | 3 | 0,05         | SD 12×18×3  |            | 28    | 4 | 0,11         | SD 20×28×4  |
|            | 19    | 3 | 0,1          | G 12×19×3   | 21         | 29    | 4 | 0,22         | G 21×29×4   |
|            | 19    | 3 | 0,06         | SD 12×19×3  | 22         | 28    | 4 | 0,18         | G 22×28×4   |
| 13         | 19    | 3 | 0,09         | G 13×19×3   |            | 28    | 4 | 0,09         | SD 22×28×4  |
| 14         | 20    | 3 | 0,1          | G 14×20×3   |            | 30    | 4 | 0,22         | G 22×30×4   |
|            | 20    | 3 | 0,05         | SD 14×20×3  |            | 30    | 4 | 0,13         | SD 22×30×4  |
|            | 21    | 3 | 0,11         | G 14×21×3   | 24         | 32    | 4 | 0,25         | G 24×32×4   |
|            | 22    | 3 | 0,13         | G 14×22×3   | 25         | 32    | 4 | 0,23         | G 25×32×4   |
|            | 22    | 3 | 0,07         | SD 14×22×3  |            | 32    | 4 | 0,13         | SD 25×32×4  |
| 15         | 21    | 3 | 0,1          | G 15×21×3   |            | 33    | 4 | 0,25         | G 25×33×4   |
|            | 21    | 3 | 0,05         | SD 15×21×3  |            | 33    | 4 | 0,13         | SD 25×33×4  |
|            | 23    | 3 | 0,13         | G 15×23×3   |            | 35    | 4 | 0,26         | G 25×35×4   |
|            | 23    | 3 | 0,07         | SD 15×23×3  |            | 35    | 4 | 0,19         | SD 25×35×4  |

| Dimensions     |                |   | Mass<br>per 100 | Designation |
|----------------|----------------|---|-----------------|-------------|
| d <sub>1</sub> | d <sub>2</sub> | b |                 |             |
| mm             |                |   | kg              | –           |
| 26             | 34             | 4 | 0,26            | G 26×34×4   |
|                | 34             | 4 | 0,14            | SD 26×34×4  |
| 28             | 35             | 4 | 0,24            | G 28×35×4   |
|                | 35             | 4 | 0,13            | SD 28×35×4  |
|                | 37             | 4 | 0,31            | G 28×37×4   |
| 29             | 38             | 4 | 0,32            | G 29×38×4   |
| 30             | 37             | 4 | 0,27            | G 30×37×4   |
|                | 37             | 4 | 0,13            | SD 30×37×4  |
|                | 40             | 4 | 0,36            | G 30×40×4   |
|                | 40             | 4 | 0,21            | SD 30×40×4  |
| 32             | 42             | 4 | 0,37            | G 32×42×4   |
|                | 42             | 4 | 0,24            | SD 32×42×4  |
|                | 45             | 4 | 0,51            | G 32×45×4   |
| 35             | 42             | 4 | 0,3             | G 35×42×4   |
|                | 42             | 4 | 0,15            | SD 35×42×4  |
|                | 45             | 4 | 0,41            | G 35×45×4   |
|                | 45             | 4 | 0,25            | SD 35×45×4  |
| 37             | 47             | 4 | 0,4             | G 37×47×4   |
|                | 47             | 4 | 0,27            | SD 37×47×4  |
| 38             | 48             | 4 | 0,44            | G 38×48×4   |
|                | 48             | 4 | 0,28            | SD 38×48×4  |
| 40             | 47             | 4 | 0,33            | G 40×47×4   |
|                | 47             | 4 | 0,17            | SD 40×47×4  |
|                | 50             | 4 | 0,46            | G 40×50×4   |
|                | 50             | 4 | 0,29            | SD 40×50×4  |
|                | 52             | 5 | 0,48            | G 40×52×5   |
|                | 52             | 5 | 0,45            | SD 40×52×5  |
| 42             | 52             | 4 | 0,47            | G 42×52×4   |
|                | 52             | 4 | 0,3             | SD 42×52×4  |
| 43             | 53             | 4 | 0,48            | G 43×53×4   |

| Dimensions     |                |   | Mass<br>per 100 | Designation |
|----------------|----------------|---|-----------------|-------------|
| d <sub>1</sub> | d <sub>2</sub> | b |                 |             |
| mm             |                |   | kg              | –           |
| 45             | 52             | 4 | 0,38            | G 45×52×4   |
|                | 52             | 4 | 0,19            | SD 45×52×4  |
|                | 55             | 4 | 0,52            | G 45×55×4   |
|                | 55             | 4 | 0,32            | SD 45×55×4  |
| 50             | 58             | 4 | 0,45            | G 50×58×4   |
|                | 58             | 4 | 0,24            | SD 50×58×4  |
|                | 62             | 5 | 1,05            | G 50×62×5   |
|                | 62             | 5 | 0,55            | SD 50×62×5  |
| 55             | 63             | 5 | 0,71            | G 55×63×5   |
|                |                |   |                 |             |
| 70             | 78             | 5 | 0,9             | G 70×78×5   |





# Track runner bearings

|                                                                      |            |
|----------------------------------------------------------------------|------------|
| <b>Support rollers</b> .....                                         | <b>216</b> |
| Support rollers without flange rings .....                           | 216        |
| STO and RSTO design support rollers .....                            | 217        |
| NA 22...2RS and RNA 22...2RS design support rollers.....             | 217        |
| Support rollers with flange rings.....                               | 218        |
| NATR design support rollers .....                                    | 218        |
| NATV design support rollers .....                                    | 218        |
| NATR and NATV design support rollers, designation suffix PPA.....    | 219        |
| NUTR .. A design support rollers.....                                | 219        |
| PWTR ...2RS design support rollers.....                              | 219        |
| NNTR ...2ZL design support rollers .....                             | 220        |
| Profile of the outer ring running surface.....                       | 220        |
| Dimensions.....                                                      | 221        |
| Tolerances.....                                                      | 221        |
| Internal clearance.....                                              | 221        |
| Load carrying capacity .....                                         | 221        |
| Cages.....                                                           | 222        |
| Permissible operating temperature .....                              | 222        |
| Lubrication.....                                                     | 222        |
| Design of associated components .....                                | 223        |
| Mounting instructions.....                                           | 223        |
| Supplementary designations.....                                      | 224        |
| Product tables.....                                                  | 226        |
| 9.1 Support rollers without flange rings, without an inner ring..... | 226        |
| 9.2 Support rollers without flange rings, with an inner ring .....   | 228        |
| 9.3 Support rollers with flange rings, with an inner ring.....       | 230        |
| <br>                                                                 |            |
| <b>Cam followers</b> .....                                           | <b>238</b> |
| KR design cam followers .....                                        | 239        |
| KRE design cam followers .....                                       | 240        |
| KRV design cam followers .....                                       | 240        |
| NUKR design cam followers.....                                       | 241        |
| NUKR .. A design cam followers .....                                 | 241        |
| NUKRE .. A design cam followers .....                                | 241        |
| PWKR design cam followers .....                                      | 242        |
| PWKR ...2RS design cam followers.....                                | 242        |
| PWKRE ...2RS design cam followers .....                              | 242        |
| Profile of the outer ring running surface.....                       | 243        |
| Accessories .....                                                    | 244        |
| Dimensions.....                                                      | 246        |
| Tolerances.....                                                      | 247        |
| Internal clearance.....                                              | 247        |
| Load carrying capacity .....                                         | 248        |
| Permissible operating temperature .....                              | 248        |
| Lubrication.....                                                     | 248        |
| Design of associated components .....                                | 249        |
| Mounting instructions.....                                           | 249        |
| Supplementary designations.....                                      | 250        |
| Product tables.....                                                  | 252        |
| 9.4 Cam followers .....                                              | 252        |

# Support rollers

SKF support rollers have an internal design very similar to that of a needle or cylindrical roller bearing. They are characterized by a thick walled outer ring that enables them to accommodate shock loads while reducing distortion and bending stresses. The outer ring running surface is crowned as standard (→ **page 220**). However, support rollers with a cylindrical (flat) running surface are available for certain applications. These pre-greased, ready-to-mount units are suitable for all types of cam drives, tracks and conveyor systems.

SKF support rollers are available:

- without flange rings (→ **fig. 1**)
- with flange rings (→ **fig. 2**)

## Support rollers without flange rings

SKF supplies support rollers without separate flange rings in two designs and variants:

- with or without an inner ring
- open or sealed with two integral flanges in the outer ring

SKF support rollers without flange rings are designed for applications where associated components limit axial movement of the outer ring.

Support rollers with an inner ring have a slightly extended inner ring to enable the necessary axial movement.

Support rollers without an inner ring are intended for arrangements where the pin or shaft can be hardened and ground.

Fig. 1

Support roller without flange rings

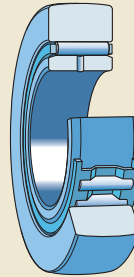
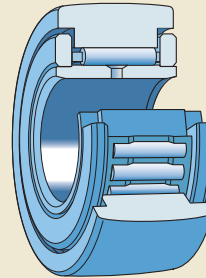

Fig. 2

Support roller with flange rings



### STO and RSTO design support rollers

STO design support rollers (→ **fig. 3**) have an inner ring, while RSTO design support rollers (→ **fig. 4**) do not have an inner ring. Both designs are available only as open (without seals) support rollers, making it possible to mount each component separately. However, needle roller and cage assemblies and support roller outer rings must always be kept together as supplied.

### NA 22...2RS and RNA 22...2RS design support rollers

NA 22...2RS design support rollers (→ **fig. 5**) have an inner ring that can be mounted individually. RNA 22...2RS design support rollers (→ **fig. 6**) do not have an inner ring and are intended for arrangements where the pin or shaft can be hardened and ground.

The needle roller and cage assembly is axially guided between two integral flanges in the outer ring and forms a non-separable unit with the outer ring.

Both of these designs are fitted with contact seals made of oil and wear-resistant acrylonitrile-butadiene rubber (NBR). They are designed for applications where contamination is light to moderate and where moisture or water spray cannot be avoided.

Fig. 3

STO design support roller

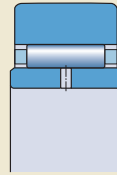

Fig. 4

RSTO design support roller

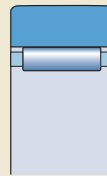

Fig. 5

NA 22...2RS design support roller

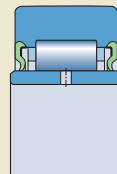
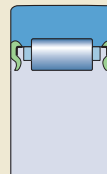

Fig. 6

RNA 22...2RS design support roller



## Support rollers

### Support rollers with flange rings

Support rollers with flange rings are non-separable units and are available in different designs and variants:

- with gap-type, labyrinth, polyamide or rubber seals
- with needle or cylindrical rollers
- with one or two rows of rollers
- with a cage-guided or a full complement roller set

Depending on the design, the flange rings are pressed-on or loose. Support rollers with flange rings are well suited for applications where lateral (thrust) surfaces are not available (→ **fig. 7**). Thrust forces, induced when shafts are not horizontal or when there is misalignment, are accommodated by the flange rings.

#### NATR design support rollers

NATR design support rollers (→ **fig. 8**) are fitted with a needle roller and cage assembly. The outer ring is guided axially by pressed-on flange rings. The narrow gap between the flange rings and the outer ring serves as a gap-type seal.

#### NATV design support rollers

NATV design support rollers (→ **fig. 9**) are similar to the NATR design, except that they have a full complement of needle rollers. Therefore, NATV support rollers can accommodate heavier radial loads than NATR support rollers. However, because of the kinematic behaviour of the needle rollers, they are not able to operate at the same high speeds and require more frequent relubrication.

Fig. 7

Application of support roller with flange rings

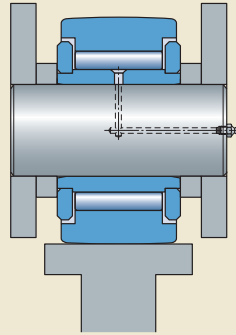

Fig. 8

NATR design support roller

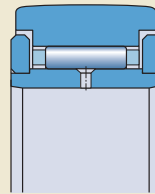
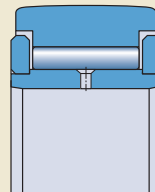

Fig. 9

NATV design support roller



### NATR and NATV design support rollers, designation suffix PPA

NATR and NATV design support rollers with the designation suffix PPA have axial sliding rings made of polyamide 66 (→ fig. 10). In the radial direction, the sliding ring forms a narrow labyrinth seal with the outer ring to protect against coarse contaminants. In the axial direction, the sliding ring serves as a contact seal to reliably retain grease in the bearing. This improves the lubrication conditions in the bearing, keeps friction and heat low, and extends grease service life.

### NUTR .. A design support rollers

NUTR .. A design support rollers (→ fig. 11) are based on double row full complement cylindrical roller bearings. The outer ring has two integral flanges to axially guide the roller complements. A loose flange ring on both sides of the inner ring provides axial guidance for the outer ring via the roller complements. This enables NUTR .. A design support rollers to accommodate axial loads that occur when operating in a tilted or inclined position and to operate at relatively high speeds.

Sheet metal angle rings that are pressed into the outer ring and extend over the flange rings hold the bearing components together and form effective labyrinth seals.

If heavy shock loads can be expected, support rollers with a reinforced outer ring should be used. These are identified by a four or five-digit number instead of a two-digit number in the bearing designation, e.g. NUTR 50110A.

### PWTR ...2RS design support rollers

PWTR ...2RS design support rollers (→ fig. 12) have a contact seal of oil and wear-resistant acrylonitrile-butadiene rubber (NBR) on both sides. The seals make these rollers particularly suitable for operation under arduous conditions. The seals, which are integral with the sheet metal angle rings, press against the flange rings. The angle rings are pressed in the outer ring and extend over the flange rings to hold the components together.

Three integral flanges in the outer ring axially guide the two full complement roller sets separately, to minimize friction in the support roller, thereby reducing the amount of heat generated by the bearing. A loose flange ring on both sides of the inner ring provides axial guidance for the outer ring via the roller complements. This

Fig. 10

NATR design support roller, designation suffix PPA

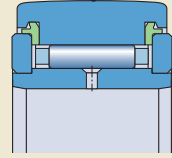

NATR .. PPA series

NATV design support roller, designation suffix PPA

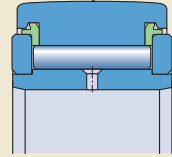

NATV .. PPA series

Fig. 11

NUTR .. A design support roller

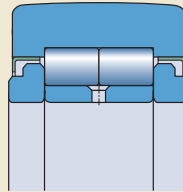
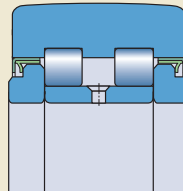

Fig. 12

PWTR ...2RS design support roller



## Support rollers

enables the support rollers to accommodate axial loads that occur when operating in a tilted or inclined position.

The large space between the two rows of rollers enables a large quantity of grease to be incorporated. The large grease fill and efficient sealing method make it possible to operate PWTR ...2RS design support rollers for much longer periods between maintenance intervals than was previously possible, even under contaminated conditions. If heavy shock loads can be expected, SKF recommends to applying support rollers with a reinforced outer ring. These are identified by a four- or five-digit number instead of a two-digit number in the bearing designation, e.g. PWTR 50110.2RS.

### NNTR ...2ZL design support rollers

NNTR ...2ZL design support rollers have a full complement of rollers (→ fig. 13) and can accommodate very heavy radial loads. NNTR ...2ZL design support rollers incorporate a lamellar seal on both sides. These seals are inserted into recesses in the shoulders of the flange rings and the outer ring and provide support to hold the bearing together. Three integral flanges in the outer ring axially guide the two rows of full complement rollers separately to minimize friction in the support roller, thereby reducing the amount of heat generated by the bearing. Two loose flange rings guide the outer ring axially via the roller complements. This enables the support rollers to accommodate the relatively heavy constant axial loads that occur when support rollers operate in an inclined position.

### Profile of the outer ring running surface

#### Crowned outer ring running surface

SKF supplies support rollers, as standard, with a crowned outer ring running surface. This surface provides good load distribution during operation when the bearing is in a tilted or inclined position.

The crowned running surface has a radius of 500 mm for the following support roller designs:

- STO and RSTO designs
- NA 22...2RS and RNA 22...2RS designs
- NATR and NATV without designation suffix

Fig. 13

NNTR ...2ZL design support roller

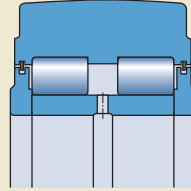

SKF also supplies support rollers with an improved crowned profile of the outer ring running surface. The modified line contact provides even better load distribution than the standard radius. In practice, this modified line contact provides a higher degree of stiffness while reducing wear between the outer ring running surface and the track.

The following support roller designs have an improved crowned profile:

- NATR and NATV designs, designation suffix PPA
- NUTR ..A design
- PWTR ...2RS design

The crowned running surface of NNTR...2ZL design support rollers depends on the outside diameter of the bearing:

- a 10 000 mm radius for an outside diameter  $\leq 260$  mm
- a 15 000 mm radius for an outside diameter  $\geq 290$  mm

#### Cylindrical outer ring running surface

SKF recommends support rollers with a cylindrical (flat) outer ring running surface for applications requiring a high degree of stiffness and when operating in a tilted or inclined position can be avoided. They are identified by the designation suffix X. These support rollers are dimensionally interchangeable with standard profile support rollers. For additional information, contact the SKF application engineering service.

## Dimensions

The dimensions of (R)NA 22...2RS design support rollers are in accordance with ISO 15:1998. The dimensions of NATR, NATV, NUTR ..A and PWTR ...2RS design support rollers, where standardized, are in accordance with ISO 7063:2003 and ANSI/ABMA Standard 18.1-1982.

## Tolerances

SKF supplies support rollers to Normal tolerances in accordance with ISO 492:2002. Exceptions are:

- the tolerance for the outside diameter D of the running surface with a crowned profile, 0/-0,050 mm
- the tolerance for the outside diameter D of the running surface of the NNTR ...2ZL design support rollers, h10 tolerance class
- the tolerance for the width B of NNTR design support rollers, 0/-0,50 mm
- the tolerance for the width B of NATR, NATV, NUTR ..A and PWTR ...2RS design support rollers, h12 tolerance class
- the tolerance for the circularity of the inner rings of NATR and NATV design support rollers

The inside diameter  $F_w$  of the roller sets for RSTO and RNA 22...2RS design support rollers lies within the limits of F6 tolerance class.

The limits for h10, h12 and F6 tolerance classes are listed in **table 1**.

## Internal clearance

SKF supplies support rollers with a radial internal clearance in the range of C2 to Normal. However, STO and NA 22...2RS design support rollers without a flange ring have Normal radial internal clearance.

The clearance values are listed in **table 7** on **page 42** and are in accordance with ISO 5753-1:2009. They are valid for unmounted support rollers under zero measuring load.

Table 1

### ISO tolerance classes

| Nominal dimension over incl. |     | h10 Deviations high low |      | h12 Deviations high low |      | F6 Deviations high low |     |
|------------------------------|-----|-------------------------|------|-------------------------|------|------------------------|-----|
| mm                           |     | µm                      |      | µm                      |      | µm                     |     |
| 3                            | 6   | 0                       | -48  | 0                       | -120 | +18                    | +10 |
| 6                            | 10  | 0                       | -58  | 0                       | -150 | +22                    | +13 |
| 10                           | 18  | 0                       | -70  | 0                       | -180 | +27                    | +16 |
| 18                           | 30  | 0                       | -84  | 0                       | -210 | +33                    | +20 |
| 30                           | 50  | 0                       | -100 | 0                       | -250 | +41                    | +25 |
| 50                           | 80  | 0                       | -120 | 0                       | -300 | +49                    | +30 |
| 80                           | 120 | 0                       | -140 | 0                       | -350 | +58                    | +36 |
| 120                          | 180 | 0                       | -160 | 0                       | -400 | +68                    | +43 |
| 180                          | 250 | 0                       | -185 | 0                       | -460 | +79                    | +50 |
| 250                          | 315 | 0                       | -210 | 0                       | -520 | +88                    | +56 |

## Load carrying capacity

Compared to a typical rolling bearing, where the outer ring is fully supported in a housing, a support roller has only a small contact area between its outside diameter and the track. The actual contact area depends on the applied radial load and whether the running surface is crowned or cylindrical (flat). The deformation of the outer ring, caused by this limited contact, alters the force distribution in the bearing, which affects load carrying capacity. The basic load ratings listed in the product tables take this into account.

The ability to accommodate dynamic loads depends on the requisite life, but it is also important to consider the strength of the outer ring. Therefore, the value of the maximum dynamic radial load  $F_r$  should not be exceeded.

The permissible static load for a support roller is determined by the smaller of the values  $F_{0r}$  and  $C_0$ . If requirements for smooth running are below normal, the static load may exceed  $C_0$ , but should never exceed the maximum permissible static radial load  $F_{0r}$ .

## Support rollers

### Cages

(R)STO, (R)NA 22...2RS and NATR design support rollers are fitted with a steel cage (→ **fig. 14**), except for (R)STO design support rollers with the designation suffix TN. These support rollers have a cage made of glass fibre reinforced polyamide 66 (→ **fig. 15**) that can operate at temperatures up to 120 °C.

For additional information about the temperature resistance and the applicability of cages, refer to the section *Cage materials*, starting on **page 44**.

### Permissible operating temperature

Generally, the permissible temperature range for support rollers is -30 to +140 °C.

Exceptions due to the seal and cage material are:

- -30 to +120 °C for (R)NA 22...2RS and PWTR ...2RS designs and the (R)STO design, designation suffix TN
- -30 to +100 °C for NATR and NATV designs, designation suffix PPA

Exceptions due to the applied grease must also be taken into account.

For additional information about temperature restrictions, refer to the sections *Cage materials* (→ **page 44**) and *Lubrication* (→ **page 52**).

### Lubrication

All support rollers are filled at the factory with a high-quality grease with good corrosion inhibiting properties.

Although SKF support rollers require little maintenance, they must be relubricated to achieve their full service life. SKF recommends relubrication while the initial grease fill still has its full lubricating properties. A lubrication hole is provided in the inner ring so that if suitable ducts are provided in the pin, the support rollers are easy to relubricate. Support rollers used in applications where there are light loads, relatively low speeds and clean surroundings, can operate for long periods before relubrication is required. Support rollers that operate under contaminated and damp conditions at high speeds or at temperatures above +70 °C require frequent relubrication. Full complement NATV and NUTR .. A design support rollers require more frequent relubrication. SKF recommends using SKF LGWA 2 grease for relubrication.

For additional information about greases, refer to the section *Lubrication*, starting on **page 52**.

SKF supplies all inner rings for support rollers with one lubrication hole except for inner rings of the NNTR design, which have:

- 3 lubrication holes for a bore diameter ≤ 90 mm
- 6 lubrication holes for a bore diameter ≥ 100 mm

Fig. 14

Machined steel cage

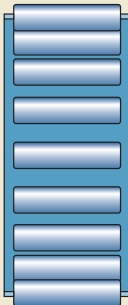
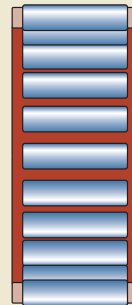

Fig. 15

Polyamide 66 cage





(R)STO design support rollers can be oil or grease lubricated. In applications where oil is used, SKF recommends thoroughly washing the initial grease fill from the bearing prior to operation.

## Design of associated components

### Axial play

Support rollers with inner rings and flange rings, if included, must be located without axial play (→ **fig. 16**).

Support rollers without an inner ring must have an axial play of 0,2 mm to the support surfaces (→ **fig. 16**).

### Support surfaces

The outer ring support surfaces of support rollers without flange rings must be fine turned, free of burrs and clean. Unhardened surfaces should extend to at least half the outer ring side face (→ **fig. 16**) while hardened surfaces may be smaller.

Heavily loaded support rollers with flange rings should be provided with complete support for the flange ring side faces and the support surface should be dimensioned according to the diameter  $d_1$  (→ **fig. 17**).

### Pins

Support rollers generally operate under conditions of stationary inner ring load. For this type of load, and if easy displacement of the inner ring is required, the pins should be machined to a g6 tolerance class. The appropriate tolerance for pins for support rollers without an inner ring is a k5 tolerance class. To exploit the full load carrying capacity of the support roller, the raceways on the pins should have the same hardness and surface finish normally found on bearing raceways. For detailed information, refer to the section *Raceways on shafts and in housings*, starting on **page 50**.

## Mounting instructions

SKF recommends positioning the lubrication hole in the unloaded zone of the support roller inner ring.

When mounting the outer ring assembly and inner ring individually, care must be taken not to damage the lips of the seals.

Fig. 16

Support roller without flange rings, axial guidance provided by associated components

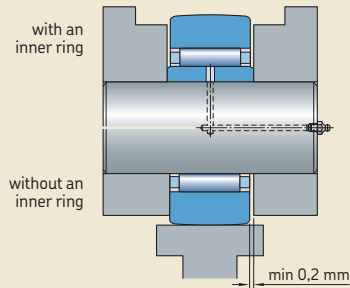
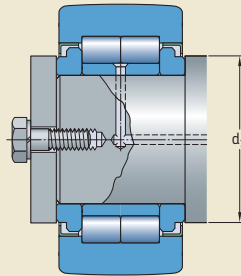

Fig. 17

Support roller with integral flanges in the outer ring, axial guidance provided by loose flange rings



## Support rollers

### Supplementary designations

The designation suffixes used to identify certain features of SKF support rollers are explained in the following.

- .2RS** Contact seal of acrylonitrile-butadiene rubber (NBR) on both sides of the support roller
- .2ZL** Support rollers with a lamellar seal on both sides
- A** NUTR design support rollers with an improved crowned profile of the outer ring running surface
- PPA** NATR or NATV design support rollers with a polyamide 66 axial sliding and sealing ring on both sides. Improved crowned profile of the outer ring running surface.
- TN** Injection moulded cage of glass fibre reinforced polyamide 66
- X** Cylindrical (flat) profile of the outer ring running surface



Support rollers without flange rings, without an inner ring  
D 16 – 90 mm

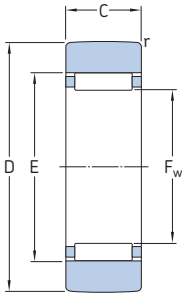

RSTO

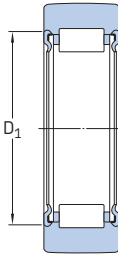

RNA 22...2RS

| Dimensions |      |                |                |    |     | Mass   | Designation  |
|------------|------|----------------|----------------|----|-----|--------|--------------|
| D          | C    | D <sub>1</sub> | F <sub>w</sub> | E  | r   |        |              |
| mm         |      |                |                |    |     | kg     | –            |
| 16         | 7,8  | –              | 7              | 10 | 0,3 | 0,0085 | RSTO 5 TN    |
| 19         | 9,8  | –              | 10             | 13 | 0,3 | 0,013  | RSTO 6 TN    |
|            | 11,8 | 16             | 10             | –  | 0,3 | 0,018  | RNA 22/6.2RS |
| 24         | 9,8  | –              | 12             | 15 | 0,3 | 0,021  | RSTO 8 TN    |
|            | 11,8 | 18             | 12             | –  | 0,3 | 0,029  | RNA 22/8.2RS |
| 30         | 11,8 | –              | 14             | 20 | 0,3 | 0,042  | RSTO 10      |
|            | 13,8 | 20             | 14             | –  | 0,6 | 0,052  | RNA 2200.2RS |
| 32         | 11,8 | –              | 16             | 22 | 0,3 | 0,049  | RSTO 12      |
|            | 13,8 | 22             | 16             | –  | 0,6 | 0,057  | RNA 2201.2RS |
| 35         | 11,8 | –              | 20             | 26 | 0,3 | 0,050  | RSTO 15      |
|            | 13,8 | 26             | 20             | –  | 0,6 | 0,060  | RNA 2202.2RS |
| 40         | 15,8 | 28             | 22             | –  | 1   | 0,094  | RNA 2203.2RS |
|            | 15,8 | –              | 22             | 29 | 0,3 | 0,088  | RSTO 17      |
| 47         | 15,8 | –              | 25             | 32 | 0,3 | 0,13   | RSTO 20      |
|            | 17,8 | 33             | 25             | –  | 1   | 0,15   | RNA 2204.2RS |
| 52         | 15,8 | –              | 30             | 37 | 0,3 | 0,15   | RSTO 25      |
|            | 17,8 | 38             | 30             | –  | 1   | 0,18   | RNA 2205.2RS |
| 62         | 19,8 | 43             | 35             | –  | 1   | 0,28   | RNA 2206.2RS |
|            | 19,8 | –              | 38             | 46 | 0,6 | 0,26   | RSTO 30      |
| 72         | 19,8 | –              | 42             | 50 | 0,6 | 0,38   | RSTO 35      |
|            | 22,7 | 50             | 42             | –  | 1,1 | 0,43   | RNA 2207.2RS |
| 80         | 19,8 | –              | 50             | 58 | 1   | 0,42   | RSTO 40      |
|            | 22,7 | 57             | 48             | –  | 1,1 | 0,53   | RNA 2208.2RS |
| 85         | 19,8 | –              | 55             | 63 | 1   | 0,45   | RSTO 45      |
| 90         | 19,8 | –              | 60             | 68 | 1   | 0,48   | RSTO 50      |

| Designation  | Basic load ratings |                | Fatigue load limit | Maximum radial forces |                 | Limiting speed |
|--------------|--------------------|----------------|--------------------|-----------------------|-----------------|----------------|
|              | dynamic            | static         |                    | dynamic               | static          |                |
|              | C                  | C <sub>0</sub> | P <sub>u</sub>     | F <sub>r</sub>        | F <sub>0r</sub> |                |
| –            | kN                 |                | kN                 | kN                    |                 | r/min          |
| RSTO 5 TN    | 2,51               | 2,5            | 0,27               | 3,55                  | 5               | 8 000          |
| RSTO 6 TN    | 3,74               | 4,5            | 0,5                | 4,25                  | 6,1             | 7 000          |
| RNA 22/6.2RS | 3,52               | 3              | 0,34               | 1,93                  | 2,75            | 7 000          |
| RSTO 8 TN    | 4,13               | 5,4            | 0,6                | 7,5                   | 10,8            | 7 000          |
| RNA 22/8.2RS | 4,46               | 4,4            | 0,5                | 5                     | 7,1             | 6 700          |
| RSTO 10      | 8,25               | 8,8            | 1,04               | 8,5                   | 12,2            | 6 000          |
| RNA 2200.2RS | 6,44               | 7,2            | 0,85               | 12                    | 17              | 6 300          |
| RSTO 12      | 8,8                | 9,8            | 1,18               | 8,3                   | 12              | 5 600          |
| RNA 2201.2RS | 6,93               | 8,15           | 0,965              | 11,6                  | 16,6            | 6 000          |
| RSTO 15      | 9,13               | 10,6           | 1,27               | 7,1                   | 10              | 5 000          |
| RNA 2202.2RS | 7,21               | 9              | 1,04               | 9,65                  | 13,7            | 5 000          |
| RNA 2203.2RS | 9,35               | 12,9           | 1,53               | 16                    | 22,8            | 4 500          |
| RSTO 17      | 14,2               | 17,6           | 2,08               | 12                    | 17,3            | 4 500          |
| RSTO 20      | 16,1               | 21,2           | 2,5                | 18,6                  | 26,5            | 4 000          |
| RNA 2204.2RS | 15,4               | 17,3           | 2,12               | 17,6                  | 25,5            | 4 000          |
| RSTO 25      | 16,5               | 22,8           | 2,7                | 18                    | 26              | 3 400          |
| RNA 2205.2RS | 16,1               | 19             | 2,32               | 17,3                  | 24,5            | 3 400          |
| RNA 2206.2RS | 17,6               | 24,5           | 3                  | 28,5                  | 40,5            | 2 800          |
| RSTO 30      | 22,9               | 34,5           | 4,25               | 23,6                  | 33,5            | 2 600          |
| RSTO 35      | 24,6               | 39             | 4,8                | 36                    | 51              | 2 200          |
| RNA 2207.2RS | 22                 | 34             | 4,3                | 39                    | 56              | 2 200          |
| RSTO 40      | 23,8               | 39             | 4,75               | 34,5                  | 49              | 1 900          |
| RNA 2208.2RS | 27                 | 39             | 4,9                | 37,5                  | 53              | 1 900          |
| RSTO 45      | 25,1               | 43             | 5,3                | 34,5                  | 50              | 1 700          |
| RSTO 50      | 26                 | 45,5           | 5,7                | 34,5                  | 50              | 1 600          |

Support rollers without flange rings, with an inner ring  
D 19 – 90 mm

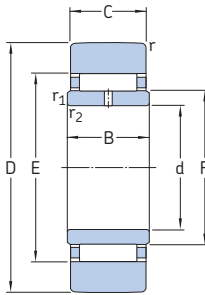

STO

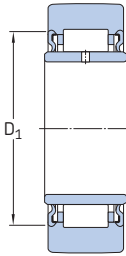

NA 22...2RS

| Dimensions |    |      |    |                |    |    |                  |                      | Mass  | Designation             |
|------------|----|------|----|----------------|----|----|------------------|----------------------|-------|-------------------------|
| D          | d  | C    | B  | D <sub>1</sub> | F  | E  | r <sub>min</sub> | r <sub>1,2 min</sub> |       |                         |
| mm         |    |      |    |                |    |    |                  |                      | kg    | –                       |
| 19         | 6  | 9,8  | 10 | –              | 10 | 13 | 0,3              | 0,3                  | 0,017 | STO 6 TN<br>NA 22/6.2RS |
|            | 6  | 11,8 | 12 | 16             | 10 | –  | 0,3              | 0,3                  | 0,022 |                         |
| 24         | 8  | 9,8  | 10 | –              | 12 | 15 | 0,3              | 0,3                  | 0,026 | STO 8 TN<br>NA 22/8.2RS |
|            | 8  | 11,8 | 12 | 18             | 12 | –  | 0,3              | 0,3                  | 0,034 |                         |
| 30         | 10 | 11,8 | 12 | –              | 14 | 20 | 0,3              | 0,3                  | 0,049 | STO 10<br>NA 2200.2RS   |
|            | 10 | 13,8 | 14 | 20             | 14 | –  | 0,6              | 0,3                  | 0,06  |                         |
| 32         | 12 | 11,8 | 12 | –              | 16 | 22 | 0,3              | 0,3                  | 0,057 | STO 12<br>NA 2201.2RS   |
|            | 12 | 13,8 | 14 | 22             | 16 | –  | 0,6              | 0,3                  | 0,067 |                         |
| 35         | 15 | 11,8 | 12 | –              | 20 | 26 | 0,3              | 0,3                  | 0,063 | STO 15<br>NA 2202.2RS   |
|            | 15 | 13,8 | 14 | 26             | 20 | –  | 0,6              | 0,3                  | 0,075 |                         |
| 40         | 17 | 15,8 | 16 | –              | 22 | 29 | 0,3              | 0,3                  | 0,11  | STO 17<br>NA 2203.2RS   |
|            | 17 | 15,8 | 16 | 28             | 22 | –  | 1                | 0,3                  | 0,11  |                         |
| 47         | 20 | 15,8 | 16 | –              | 25 | 32 | 0,3              | 0,3                  | 0,15  | STO 20<br>NA 2204.2RS   |
|            | 20 | 17,8 | 18 | 33             | 25 | –  | 1                | 0,3                  | 0,18  |                         |
| 52         | 25 | 15,8 | 16 | –              | 30 | 37 | 0,3              | 0,3                  | 0,18  | STO 25<br>NA 2205.2RS   |
|            | 25 | 17,8 | 18 | 38             | 30 | –  | 1                | 0,3                  | 0,21  |                         |
| 62         | 30 | 19,8 | 20 | –              | 38 | 46 | 0,6              | 0,6                  | 0,31  | STO 30<br>NA 2206.2RS   |
|            | 30 | 19,8 | 20 | 43             | 35 | –  | 1                | 0,3                  | 0,32  |                         |
| 72         | 35 | 19,8 | 20 | –              | 42 | 50 | 0,6              | 0,6                  | 0,44  | STO 35<br>NA 2207.2RS   |
|            | 35 | 22,7 | 23 | 50             | 42 | –  | 1,1              | 0,6                  | 0,51  |                         |
| 80         | 40 | 19,8 | 20 | –              | 50 | 58 | 1                | 1                    | 0,53  | STO 40<br>NA 2208.2RS   |
|            | 40 | 22,7 | 23 | 57             | 48 | –  | 1,1              | 0,6                  | 0,63  |                         |
| 85         | 45 | 19,8 | 20 | –              | 55 | 63 | 1                | 1                    | 0,58  | STO 45                  |
| 90         | 50 | 19,8 | 20 | –              | 60 | 68 | 1                | 1                    | 0,62  | STO 50<br>NA 2210.2RS   |
|            | 50 | 22,7 | 23 | 68             | –  | –  | 1,1              | 0,6                  | 0,69  |                         |

| Designation | Basic load ratings |                | Fatigue load limit | Maximum radial forces |                 | Limiting speed |
|-------------|--------------------|----------------|--------------------|-----------------------|-----------------|----------------|
|             | dynamic            | static         |                    | dynamic               | static          |                |
|             | C                  | C <sub>0</sub> | P <sub>u</sub>     | F <sub>r</sub>        | F <sub>0r</sub> |                |
| –           | kN                 |                | kN                 | kN                    |                 | r/min          |
| STO 6 TN    | 3,74               | 4,5            | 0,5                | 4,25                  | 6,1             | 7 000          |
| NA 22/6.2RS | 3,52               | 3              | 0,34               | 1,93                  | 2,75            | 7 000          |
| STO 8 TN    | 4,13               | 5,4            | 0,6                | 7,5                   | 10,8            | 7 000          |
| NA 22/8.2RS | 4,46               | 4,4            | 0,5                | 5                     | 7,1             | 6 700          |
| STO 10      | 8,25               | 8,8            | 1,04               | 8,5                   | 12,2            | 6 000          |
| NA 2200.2RS | 6,44               | 7,2            | 0,85               | 12                    | 17              | 6 300          |
| STO 12      | 8,8                | 9,8            | 1,18               | 8,3                   | 12              | 5 600          |
| NA 2201.2RS | 6,93               | 8,15           | 0,965              | 11,6                  | 16,6            | 6 000          |
| STO 15      | 9,13               | 10,6           | 1,27               | 7,1                   | 10              | 5 000          |
| NA 2202.2RS | 7,21               | 9              | 1,04               | 9,65                  | 13,7            | 5 000          |
| STO 17      | 14,2               | 17,6           | 2,08               | 12                    | 17,3            | 4 500          |
| NA 2203.2RS | 9,35               | 12,9           | 1,53               | 16                    | 22,8            | 4 500          |
| STO 20      | 16,1               | 21,2           | 2,5                | 18,6                  | 26,5            | 4 000          |
| NA 2204.2RS | 15,4               | 17,3           | 2,12               | 17,6                  | 25,5            | 4 000          |
| STO 25      | 16,5               | 22,8           | 2,7                | 18                    | 26              | 3 400          |
| NA 2205.2RS | 16,1               | 19             | 2,32               | 17,3                  | 24,5            | 3 400          |
| STO 30      | 22,9               | 34,5           | 4,25               | 23,6                  | 33,5            | 2 800          |
| NA 2206.2RS | 17,6               | 24,5           | 3                  | 28,5                  | 40,5            | 2 600          |
| STO 35      | 25,5               | 40,5           | 5                  | 36                    | 51              | 2 200          |
| NA 2207.2RS | 22                 | 34             | 4,3                | 39                    | 56              | 2 200          |
| STO 40      | 23,8               | 39             | 4,75               | 34,5                  | 49              | 1 900          |
| NA 2208.2RS | 27                 | 39             | 4,9                | 37,5                  | 53              | 1 900          |
| STO 45      | 25,1               | 43             | 5,3                | 34,5                  | 50              | 1 700          |
| STO 50      | 26                 | 45,5           | 5,7                | 34,5                  | 50              | 1 600          |
| NA 2210.2RS | 27                 | 41,5           | 5,2                | 36,5                  | 52              | 1 600          |

**Support rollers with flange rings, with an inner ring**  
**D 16 – 40 mm**

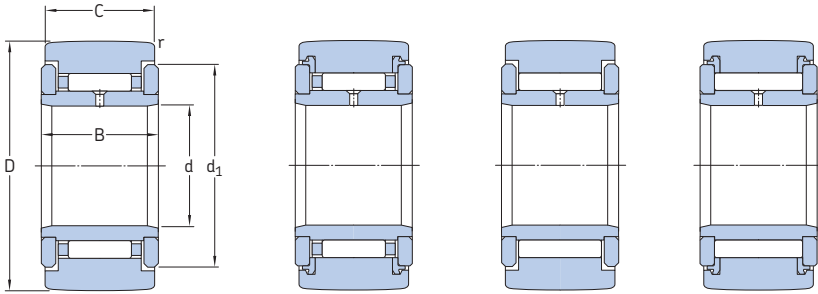

NATR

NATR .. PPA

NATV

NATV .. PPA

| Dimensions |    |    |    |                | Mass             |                      | Designation |
|------------|----|----|----|----------------|------------------|----------------------|-------------|
| D          | d  | C  | B  | d <sub>1</sub> | r <sub>min</sub> | r <sub>1,2 min</sub> |             |
| mm         |    |    |    |                |                  | kg                   | –           |
| 16         | 5  | 11 | 12 | 12             | 0,15             | –                    | NATR 5      |
|            | 5  | 11 | 12 | 12             | 0,15             | –                    | NATR 5 PPA  |
|            | 5  | 11 | 12 | 12             | 0,15             | –                    | NATV 5      |
|            | 5  | 11 | 12 | 12             | 0,15             | –                    | NATV 5 PPA  |
| 19         | 6  | 11 | 12 | 14             | 0,15             | –                    | NATR 6      |
|            | 6  | 11 | 12 | 14             | 0,15             | –                    | NATR 6 PPA  |
|            | 6  | 11 | 12 | 14             | 0,15             | –                    | NATV 6      |
|            | 6  | 11 | 12 | 14             | 0,15             | –                    | NATV 6 PPA  |
| 24         | 8  | 14 | 15 | 19             | 0,3              | –                    | NATR 8      |
|            | 8  | 14 | 15 | 19             | 0,3              | –                    | NATR 8 PPA  |
|            | 8  | 14 | 15 | 19             | 0,3              | –                    | NATV 8      |
|            | 8  | 14 | 15 | 19             | 0,3              | –                    | NATV 8 PPA  |
| 30         | 10 | 14 | 15 | 23             | 0,6              | –                    | NATR 10     |
|            | 10 | 14 | 15 | 23             | 0,6              | –                    | NATR 10 PPA |
|            | 10 | 14 | 15 | 23             | 0,6              | –                    | NATV 10     |
|            | 10 | 14 | 15 | 23             | 0,6              | –                    | NATV 10 PPA |
| 32         | 12 | 14 | 15 | 25             | 0,6              | –                    | NATR 12     |
|            | 12 | 14 | 15 | 25             | 0,6              | –                    | NATR 12 PPA |
|            | 12 | 14 | 15 | 25             | 0,6              | –                    | NATV 12     |
|            | 12 | 14 | 15 | 25             | 0,6              | –                    | NATV 12 PPA |
| 35         | 15 | 18 | 19 | 27             | 0,6              | –                    | NATR 15     |
|            | 15 | 18 | 19 | 27             | 0,6              | –                    | NATR 15 PPA |
|            | 15 | 18 | 19 | 27             | 0,6              | –                    | NATV 15     |
|            | 15 | 18 | 19 | 27             | 0,6              | –                    | NATV 15 PPA |
|            | 15 | 18 | 19 | 20             | 0,6              | 0,6                  | NATR 15 A   |
|            | 15 | 18 | 19 | 20             | 0,6              | 0,6                  | PWTR 15.2RS |
| 40         | 17 | 20 | 21 | 32             | 1                | –                    | NATR 17     |
|            | 17 | 20 | 21 | 32             | 1                | –                    | NATR 17 PPA |
|            | 17 | 20 | 21 | 32             | 1                | –                    | NATV 17     |
|            | 17 | 20 | 21 | 32             | 1                | –                    | NATV 17 PPA |
|            | 17 | 20 | 21 | 22             | 1                | 0,5                  | NATR 17 A   |
|            | 17 | 20 | 21 | 22             | 1                | 0,5                  | PWTR 17.2RS |



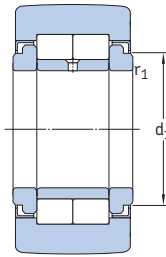

NUTR...A

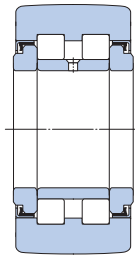

PWTR...2RS

| Designation | Basic load ratings |                | Fatigue load limit | Maximum radial forces |                 | Limiting speed |
|-------------|--------------------|----------------|--------------------|-----------------------|-----------------|----------------|
|             | dynamic            | static         |                    | dynamic               | static          |                |
| –           | C                  | C <sub>0</sub> | P <sub>u</sub>     | F <sub>r</sub>        | F <sub>0r</sub> | r/min          |
| –           | kN                 |                | kN                 | kN                    |                 |                |
| NATR 5      | 3,14               | 3,2            | 0,345              | 2,9                   | 4,15            | 6 000          |
| NATR 5 PPA  | 3,14               | 3,2            | 0,345              | 2,9                   | 4,15            | 6 000          |
| NATV 5      | 4,73               | 6,55           | 0,72               | 4,05                  | 5,7             | 4 300          |
| NATV 5 PPA  | 4,73               | 6,55           | 0,72               | 4,05                  | 5,7             | 4 300          |
| NATR 6      | 3,47               | 3,8            | 0,415              | 3,8                   | 5,5             | 5 600          |
| NATR 6 PPA  | 3,47               | 3,8            | 0,415              | 3,8                   | 5,5             | 5 600          |
| NATV 6      | 5,28               | 8              | 0,88               | 5,1                   | 7,35            | 4 000          |
| NATV 6 PPA  | 5,28               | 8              | 0,88               | 5,1                   | 7,35            | 4 000          |
| NATR 8      | 5,28               | 6,1            | 0,695              | 5,2                   | 7,35            | 5 000          |
| NATR 8 PPA  | 5,28               | 6,1            | 0,695              | 5,2                   | 7,35            | 5 000          |
| NATV 8      | 7,48               | 11,4           | 1,32               | 7,35                  | 10,4            | 3 600          |
| NATV 8 PPA  | 7,48               | 11,4           | 1,32               | 7,35                  | 10,4            | 3 600          |
| NATR 10     | 6,44               | 8              | 0,88               | 7,8                   | 11,2            | 4 800          |
| NATR 10 PPA | 6,44               | 8              | 0,88               | 7,8                   | 11,2            | 4 800          |
| NATV 10     | 8,97               | 14,6           | 1,66               | 11                    | 15,6            | 3 200          |
| NATV 10 PPA | 8,97               | 14,6           | 1,66               | 11                    | 15,6            | 3 200          |
| NATR 12     | 6,6                | 8,5            | 0,95               | 7,65                  | 10,8            | 4 500          |
| NATR 12 PPA | 6,6                | 8,5            | 0,95               | 7,65                  | 10,8            | 4 500          |
| NATV 12     | 9,35               | 15,3           | 1,76               | 10,6                  | 15              | 3 000          |
| NATV 12 PPA | 9,35               | 15,3           | 1,76               | 10,6                  | 15              | 3 000          |
| NATR 15     | 9,52               | 13,7           | 1,56               | 11,4                  | 16,3            | 4 000          |
| NATR 15 PPA | 9,52               | 13,7           | 1,56               | 11,4                  | 16,3            | 4 000          |
| NATV 15     | 12,3               | 23,2           | 2,7                | 14,6                  | 20,8            | 2 600          |
| NATV 15 PPA | 12,3               | 23,2           | 2,7                | 14,6                  | 20,8            | 2 600          |
| NUTR 15 A   | 16,8               | 17,6           | 2                  | 8,65                  | 12,2            | 5 000          |
| PWTR 15.2RS | 11,9               | 11,4           | 1,2                | 8,65                  | 12,5            | 5 000          |
| NATR 17     | 10,5               | 14,6           | 1,73               | 12,5                  | 18              | 3 400          |
| NATR 17 PPA | 10,5               | 14,6           | 1,73               | 12,5                  | 18              | 3 400          |
| NATV 17     | 14,2               | 26,5           | 3,1                | 17                    | 24,5            | 2 200          |
| NATV 17 PPA | 14,2               | 26,5           | 3,1                | 17                    | 24,5            | 2 200          |
| NUTR 17 A   | 19                 | 22             | 2,5                | 14                    | 20              | 4 500          |
| PWTR 17.2RS | 13,8               | 14,3           | 1,5                | 13,7                  | 19,6            | 4 500          |

Support rollers with flange rings, with an inner ring  
D 42 – 72 mm

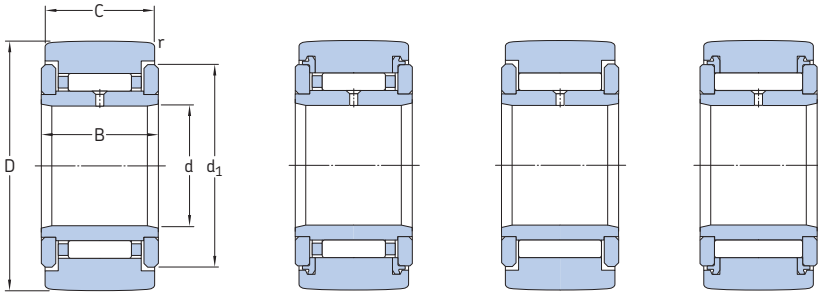

NATR

NATR .. PPA

NATV

NATV .. PPA

| Dimensions |    |    |    |                |                  |                      | Mass | Designation   |
|------------|----|----|----|----------------|------------------|----------------------|------|---------------|
| D          | d  | C  | B  | d <sub>1</sub> | r <sub>min</sub> | r <sub>1,2 min</sub> |      |               |
| mm         |    |    |    |                |                  |                      | kg   | –             |
| 42         | 15 | 18 | 19 | 20             | 0,6              | 0,3                  | 0,16 | NUTR 1542 A   |
|            | 15 | 18 | 19 | 20             | 0,6              | 0,3                  | 0,16 | PWTR 1542.2RS |
| 47         | 17 | 20 | 21 | 22             | 1                | 0,5                  | 0,22 | NUTR 1747 A   |
|            | 17 | 20 | 21 | 22             | 1                | 0,5                  | 0,22 | PWTR 1747.2RS |
|            | 20 | 24 | 25 | 37             | 1                | –                    | 0,25 | NATR 20       |
|            | 20 | 24 | 25 | 37             | 1                | –                    | 0,25 | NATR 20 PPA   |
|            | 20 | 24 | 25 | 37             | 1                | –                    | 0,25 | NATV 20       |
|            | 20 | 24 | 25 | 37             | 1                | –                    | 0,25 | NATV 20 PPA   |
|            | 20 | 24 | 25 | 27             | 1                | 0,5                  | 0,25 | NUTR 20 A     |
|            | 20 | 24 | 25 | 27             | 1                | 0,5                  | 0,25 | PWTR 20.2RS   |
| 52         | 20 | 24 | 25 | 27             | 1                | 0,5                  | 0,32 | NUTR 2052 A   |
|            | 20 | 24 | 25 | 27             | 1                | 0,5                  | 0,32 | PWTR 2052.2RS |
|            | 25 | 24 | 25 | 42             | 1                | –                    | 0,28 | NATR 25       |
|            | 25 | 24 | 25 | 42             | 1                | –                    | 0,28 | NATR 25 PPA   |
|            | 25 | 24 | 25 | 42             | 1                | –                    | 0,29 | NATV 25       |
|            | 25 | 24 | 25 | 42             | 1                | –                    | 0,29 | NATV 25 PPA   |
|            | 25 | 24 | 25 | 31             | 1                | 0,5                  | 0,28 | NUTR 25 A     |
|            | 25 | 24 | 25 | 31             | 1                | 0,5                  | 0,28 | PWTR 25.2RS   |
| 62         | 25 | 24 | 25 | 31             | 1                | 0,5                  | 0,45 | NUTR 2562 A   |
|            | 25 | 24 | 25 | 31             | 1                | 0,5                  | 0,45 | PWTR 2562.2RS |
|            | 30 | 28 | 29 | 51             | 1                | –                    | 0,47 | NATR 30       |
|            | 30 | 28 | 29 | 51             | 1                | –                    | 0,47 | NATR 30 PPA   |
|            | 30 | 28 | 29 | 51             | 1                | –                    | 0,48 | NATV 30       |
|            | 30 | 28 | 29 | 51             | 1                | –                    | 0,48 | NATV 30 PPA   |
|            | 30 | 28 | 29 | 38             | 1                | 0,5                  | 0,47 | NUTR 30 A     |
|            | 30 | 28 | 29 | 38             | 1                | 0,5                  | 0,47 | PWTR 30.2RS   |
| 72         | 30 | 28 | 29 | 38             | 1                | 0,5                  | 0,7  | NUTR 3072 A   |
|            | 30 | 28 | 29 | 38             | 1                | 0,5                  | 0,7  | PWTR 3072.2RS |
|            | 35 | 28 | 29 | 58             | 1,1              | –                    | 0,64 | NATR 35 PPA   |
|            | 35 | 28 | 29 | 58             | 1,1              | –                    | 0,65 | NATV 35 PPA   |
|            | 35 | 28 | 29 | 44             | 1,1              | 0,6                  | 0,63 | NUTR 35 A     |
|            | 35 | 28 | 29 | 44             | 1,1              | 0,6                  | 0,63 | PWTR 35.2RS   |

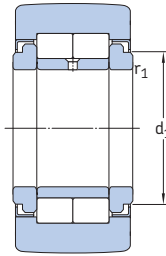

NUTR...A

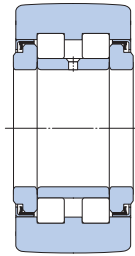

PWTR...2RS

| Designation   | Basic load ratings |                | Fatigue load limit | Maximum radial forces |                 | Limiting speed |
|---------------|--------------------|----------------|--------------------|-----------------------|-----------------|----------------|
|               | dynamic            | static         |                    | dynamic               | static          |                |
| –             | C                  | C <sub>0</sub> | P <sub>u</sub>     | F <sub>r</sub>        | F <sub>0r</sub> | r/min          |
| –             | kN                 |                | kN                 | kN                    |                 |                |
| NUTR 1542 A   | 20,1               | 23,2           | 2,65               | 21,6                  | 31              | 5 000          |
| PWTR 1542.2RS | 14,2               | 15             | 1,6                | 22                    | 31,5            | 5 000          |
| NUTR 1747 A   | 22                 | 27             | 3,05               | 30                    | 43              | 4 500          |
| PWTR 1747.2RS | 15,7               | 17,6           | 1,86               | 30                    | 42,5            | 4 500          |
| NATR 20       | 14,7               | 24,5           | 2,9                | 23,6                  | 33,5            | 3 000          |
| NATR 20 PPA   | 14,7               | 24,5           | 2,9                | 23,6                  | 33,5            | 3 000          |
| NATV 20       | 19,4               | 41,5           | 5                  | 30,5                  | 43              | 1 900          |
| NATV 20 PPA   | 19,4               | 41,5           | 5                  | 30,5                  | 43              | 1 900          |
| NUTR 20 A     | 28,6               | 33,5           | 3,9                | 17,6                  | 25              | 3 800          |
| PWTR 20.2RS   | 22,9               | 24,5           | 2,8                | 18,3                  | 26              | 3 800          |
| NUTR 2052 A   | 31,9               | 39             | 4,55               | 30                    | 42,5            | 3 800          |
| PWTR 2052.2RS | 25,5               | 29             | 3,35               | 30,5                  | 44              | 3 800          |
| NATR 25       | 14,7               | 25,5           | 3,1                | 21,6                  | 31              | 2 400          |
| NATR 25 PPA   | 14,7               | 25,5           | 3,1                | 21,6                  | 31              | 2 400          |
| NATV 25       | 19,8               | 44             | 5,3                | 28,5                  | 40,5            | 1 600          |
| NATV 25 PPA   | 19,8               | 44             | 5,3                | 28,5                  | 40,5            | 1 600          |
| NUTR 25 A     | 29,7               | 36             | 4,25               | 18                    | 25,5            | 3 200          |
| PWTR 25.2RS   | 23,8               | 26,5           | 3,05               | 18,6                  | 26,5            | 3 200          |
| NUTR 2562 A   | 35,8               | 48             | 5,6                | 44                    | 63              | 3 200          |
| PWTR 2562.2RS | 29,2               | 36             | 4,05               | 45                    | 64              | 3 200          |
| NATR 30       | 22,9               | 37,5           | 4,55               | 26,5                  | 38              | 1 800          |
| NATR 30 PPA   | 22,9               | 37,5           | 4,55               | 26,5                  | 38              | 1 800          |
| NATV 30       | 29,2               | 62             | 7,65               | 34,5                  | 49              | 1 400          |
| NATV 30 PPA   | 29,2               | 62             | 7,65               | 34,5                  | 49              | 1 400          |
| NUTR 30 A     | 41,3               | 47,5           | 5,85               | 24                    | 34,5            | 2 600          |
| PWTR 30.2RS   | 31,9               | 32,5           | 4,05               | 20,4                  | 29              | 2 600          |
| NUTR 3072 A   | 48,4               | 61             | 7,5                | 53                    | 76,5            | 2 600          |
| PWTR 3072.2RS | 39,6               | 45             | 5,6                | 47,5                  | 68              | 2 000          |
| NATR 35 PPA   | 24,6               | 43             | 5,3                | 33,5                  | 48              | 1 600          |
| NATV 35 PPA   | 31,9               | 72             | 8,8                | 43                    | 62              | 1 100          |
| NUTR 35 A     | 45,7               | 57             | 6,95               | 33,5                  | 47,5            | 2 000          |
| PWTR 35.2RS   | 35,8               | 40,5           | 5                  | 28                    | 40              | 2 000          |

**Support rollers with flange rings, with an inner ring**  
**D 80 – 240 mm**

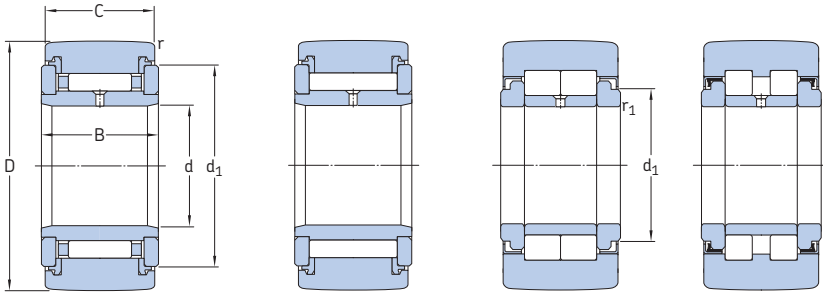

NATR .. PPA

NATV .. PPA

NUTR .. A

PWTR ...2RS

| Dimensions |     |     |     |                |                  | Mass                 | Designation |                      |
|------------|-----|-----|-----|----------------|------------------|----------------------|-------------|----------------------|
| D          | d   | C   | B   | d <sub>1</sub> | r <sub>min</sub> | r <sub>1,2 min</sub> |             |                      |
| mm         |     |     |     |                |                  | kg                   | –           |                      |
| 80         | 35  | 28  | 29  | 44             | 1,1              | 0,6                  | 0,84        | NUTR 3580 A          |
|            | 35  | 28  | 29  | 44             | 1,1              | 0,6                  | 0,84        | PWTR 3580.2RS        |
|            | 40  | 30  | 32  | 66             | 1,1              | –                    | 0,81        | NATR 40 PPA          |
|            | 40  | 30  | 32  | 66             | 1,1              | –                    | 0,89        | NATV 40 PPA          |
|            | 40  | 30  | 32  | 51             | 1,1              | 0,6                  | 0,82        | NUTR 40 A            |
|            | 40  | 30  | 32  | 51             | 1,1              | 0,6                  | 0,82        | PWTR 40.2RS          |
| 85         | 45  | 30  | 32  | 55             | 1,1              | 0,6                  | 0,88        | NUTR 45 A            |
|            | 45  | 30  | 32  | 55             | 1,1              | 0,6                  | 0,88        | PWTR 45.2RS          |
| 90         | 40  | 30  | 32  | 51             | 1,1              | 0,6                  | 1,13        | NUTR 4090 A          |
|            | 40  | 30  | 32  | 51             | 1,1              | 0,6                  | 1,13        | PWTR 4090.2RS        |
|            | 50  | 30  | 32  | 76             | 1,1              | –                    | 0,96        | NATR 50 PPA          |
|            | 50  | 30  | 32  | 76             | 1,1              | –                    | 0,99        | NATV 50 PPA          |
|            | 50  | 30  | 32  | 60             | 1,1              | 0,6                  | 0,95        | NUTR 50 A            |
|            | 50  | 30  | 32  | 60             | 1,1              | 0,6                  | 0,95        | PWTR 50.2RS          |
| 100        | 45  | 30  | 32  | 55             | 1,1              | 0,6                  | 1,4         | NUTR 45100 A         |
|            | 45  | 30  | 32  | 55             | 1,1              | 0,6                  | 1,4         | PWTR 45100.2RS       |
| 110        | 50  | 30  | 32  | 60             | 1,1              | 0,6                  | 1,7         | NUTR 50110 A         |
|            | 50  | 30  | 32  | 60             | 1,1              | 0,6                  | 1,7         | PWTR 50110.2RS       |
| 130        | 50  | 63  | 65  | 63             | 3                | 2                    | 5,2         | NNTR 50x130x65.2ZL   |
| 140        | 55  | 68  | 70  | 73             | 3                | 2                    | 6,4         | NNTR 55x140x70.2ZL   |
| 150        | 60  | 73  | 75  | 78             | 3                | 2                    | 7,8         | NNTR 60x150x75.2ZL   |
| 160        | 65  | 73  | 75  | 82             | 3                | 2                    | 8,8         | NNTR 65x160x75.2ZL   |
| 180        | 70  | 83  | 85  | 92             | 3                | 2                    | 13          | NNTR 70x180x85.2ZL   |
| 200        | 80  | 88  | 90  | 102            | 4                | 2                    | 17          | NNTR 80x200x90.2ZL   |
| 220        | 90  | 98  | 100 | 119            | 4                | 2,5                  | 22,5        | NNTR 90x220x100.2ZL  |
| 240        | 100 | 103 | 105 | 132            | 4                | 2,5                  | 28          | NNTR 100x240x105.2ZL |

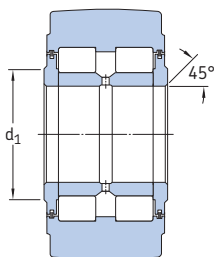

NNTR ...2ZL

| Designation          | Basic load ratings |                | Fatigue load limit | Maximum radial forces |                 | Limiting speed |
|----------------------|--------------------|----------------|--------------------|-----------------------|-----------------|----------------|
|                      | dynamic            | static         |                    | dynamic               | static          |                |
|                      | C                  | C <sub>0</sub> | P <sub>u</sub>     | F <sub>r</sub>        | F <sub>0r</sub> |                |
|                      | kN                 |                | kN                 | kN                    |                 | r/min          |
| NUTR 3580 A          | 51,2               | 68             | 8,3                | 57                    | 81,5            | 2 000          |
| PWTR 3580.2RS        | 41,8               | 50             | 6,3                | 51                    | 72              | 2 000          |
| NATR 40 PPA          | 31,9               | 57             | 7,1                | 41,5                  | 58,5            | 1 500          |
| NATV 40 PPA          | 39,1               | 88             | 11                 | 51                    | 73,5            | 950            |
| NUTR 40 A            | 57,2               | 72             | 9                  | 32                    | 45,5            | 1 800          |
| PWTR 40.2RS          | 41,8               | 49             | 6                  | 33,5                  | 48              | 1 800          |
| NUTR 45 A            | 58,3               | 75             | 9,3                | 32,5                  | 46,5            | 1 700          |
| PWTR 45.2RS          | 42,9               | 50             | 6,2                | 34                    | 48              | 1 700          |
| NUTR 4090 A          | 68,2               | 91,5           | 11,4               | 63                    | 90              | 1 800          |
| PWTR 4090.2RS        | 49,5               | 62             | 7,65               | 64                    | 91,5            | 1 800          |
| NATR 50 PPA          | 30,8               | 58,5           | 7,2                | 40                    | 57              | 1 200          |
| NATV 50 PPA          | 39,1               | 93             | 11,6               | 50                    | 72              | 850            |
| NUTR 50 A            | 58,3               | 78             | 9,65               | 32,5                  | 47,5            | 1 600          |
| PWTR 50.2RS          | 42,9               | 52             | 6,55               | 34,5                  | 49              | 1 600          |
| NUTR 45100 A         | 73,7               | 104            | 12,7               | 80                    | 114             | 1 700          |
| PWTR 45100.2RS       | 53,9               | 69,5           | 8,65               | 81,5                  | 116             | 1 700          |
| NUTR 50110 A         | 78,1               | 116            | 14,3               | 98                    | 140             | 1 600          |
| PWTR 50110.2RS       | 57,2               | 78             | 9,65               | 100                   | 143             | 1 600          |
| NNTR 50x130x65.2ZL   | 179                | 232            | 31                 | 224                   | 320             | 750            |
| NNTR 55x140x70.2ZL   | 209                | 275            | 37,5               | 224                   | 320             | 700            |
| NNTR 60x150x75.2ZL   | 238                | 320            | 42,5               | 265                   | 375             | 670            |
| NNTR 65x160x75.2ZL   | 255                | 345            | 46,5               | 285                   | 405             | 600            |
| NNTR 70x180x85.2ZL   | 330                | 455            | 61                 | 375                   | 540             | 560            |
| NNTR 80x200x90.2ZL   | 391                | 540            | 71                 | 455                   | 640             | 500            |
| NNTR 90x220x100.2ZL  | 468                | 670            | 83                 | 480                   | 680             | 430            |
| NNTR 100x240x105.2ZL | 528                | 780            | 93                 | 550                   | 780             | 380            |

**Support rollers with flange rings, with an inner ring**  
**D 260 – 310 mm**

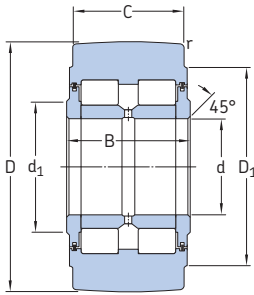

NNTR ...2ZL

| Dimensions |     |     |     |                |                  |                      | Mass | Designation                 |
|------------|-----|-----|-----|----------------|------------------|----------------------|------|-----------------------------|
| D          | d   | C   | B   | d <sub>1</sub> | r <sub>min</sub> | r <sub>1,2 min</sub> |      |                             |
| mm         |     |     |     |                |                  |                      | kg   | –                           |
| <b>260</b> | 110 | 113 | 115 | 143            | 4                | 2,5                  | 35,5 | <b>NNTR 110x260x115.2ZL</b> |
| <b>290</b> | 120 | 133 | 135 | 155            | 4                | 3                    | 53   | <b>NNTR 120x290x135.2ZL</b> |
| <b>310</b> | 130 | 144 | 146 | 165            | 5                | 3                    | 65   | <b>NNTR 130x310x146.2ZL</b> |

| Designation                 | Basic load ratings |                | Fatigue load limit | Maximum radial forces |                 | Limiting speed |
|-----------------------------|--------------------|----------------|--------------------|-----------------------|-----------------|----------------|
|                             | dynamic            | static         |                    | dynamic               | static          |                |
|                             | C                  | C <sub>0</sub> | P <sub>u</sub>     | F <sub>r</sub>        | F <sub>0r</sub> |                |
| –                           | kN                 |                | kN                 | kN                    |                 | r/min          |
| <b>NNTR 110x260x115.2ZL</b> | 627                | 930            | 112                | 655                   | 950             | 360            |
| <b>NNTR 120x290x135.2ZL</b> | 825                | 1270           | 143                | 900                   | 1290            | 320            |
| <b>NNTR 130x310x146.2ZL</b> | 952                | 1460           | 166                | 1040                  | 1500            | 300            |

## Cam followers

SKF cam followers have an internal design very similar to that of a needle or cylindrical roller bearing. They are characterized by a thick-walled outer ring that enables them to accommodate shock loads while reducing distortion and bending stresses. The outer ring running surface is crowned as standard (→ **page 243**). However, cam followers with cylindrical (flat) running surfaces are available for certain applications.

Instead of an inner ring, cam followers have a solid stud (pin) that is threaded so that the cam follower can be quickly and easily attached to appropriate machine components by means of a hexagonal nut.

Axial guidance for the outer ring is provided by an integral flange at the head of the stud and a flange ring pressed onto the stud, or by the roller complement. Cam followers are pre-greased, ready-to-mount units that are suitable for all types of cam drives, tracks and conveyor systems.

SKF cam followers are available in three basic designs:

- KR design
- NUKR design
- PWKR design

All three cam follower designs have the same main dimensions. The differences are in their internal design, which make them suitable for various operating conditions.

All designs are available with a concentric seat (→ **fig. 18**) or an eccentric collar on the stud. An eccentric collar (→ **fig. 19**), which has a shrink-fit onto the stud, enables less stringent manufacturing tolerances to be specified for associated components. The values for the adjustable eccentricity are listed in the product tables.

Fig. 18

Cam follower with a concentric seat

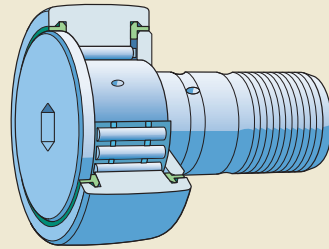

Fig. 19

Cam follower with an eccentric collar

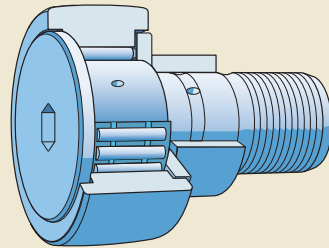
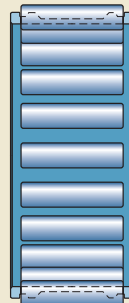

Fig. 20

Machined steel cage





## KR design cam followers

KR design cam followers are fitted with a needle roller and cage assembly (→ **fig. 20**). The steel cage guides the rollers over their entire length, permitting relatively high-speed operation. The outer ring is guided axially by the pressed-on flange ring and the head of the stud, which also serves as an integral flange.

KR design cam followers without a designation suffix or with the designation suffix B (→ **fig. 21**) have a narrow gap between the outer ring and the two flanges and serves as a gap type seal.

KR design cam followers with the designation suffix PPA have axial sliding rings made of polyamide 66 (→ **fig. 22**). In the radial direction, the sliding ring forms a narrow labyrinth seal with the outer ring to protect against coarse contaminants. In the axial direction, the sliding ring serves as a contact seal to reliably retain grease in the bearing. This improves the lubrication conditions in the bearing, keeps friction and heat low, and extends grease service life.

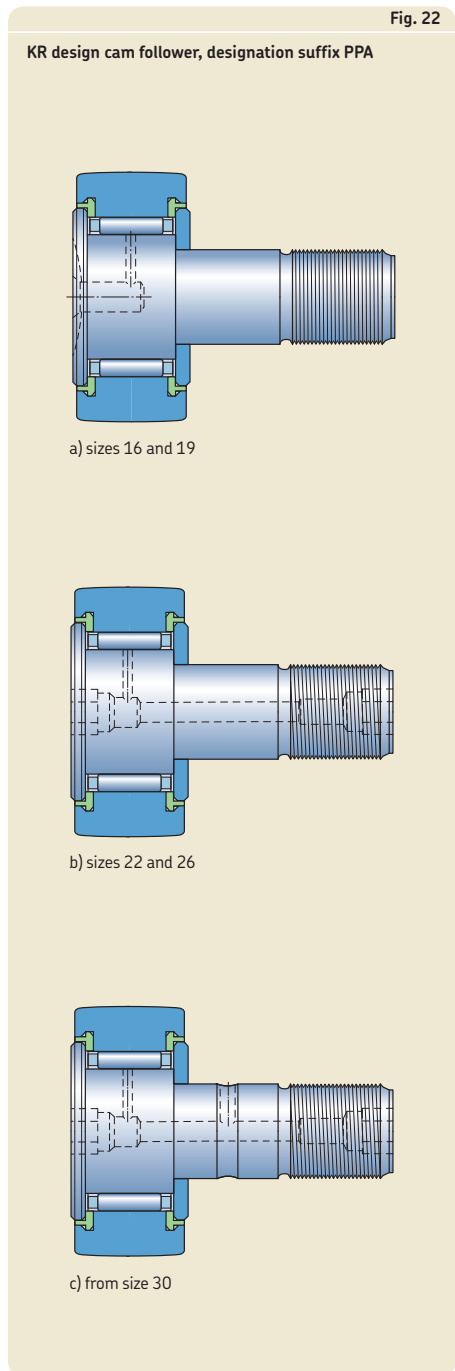
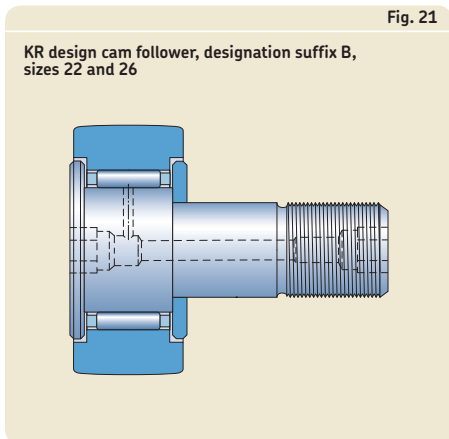

## Cam followers

KR design cam followers, sizes 16 and 19, either without a designation suffix or with the designation suffix PPA (→ **fig. 22a**, **page 239**), have one slot in the head of the stud that enables the stud to be held in place by a screwdriver during mounting. In the centre of that slot is a relubrication hole to press in a grease fitting or a plug if relubrication is not required. See section *Accessories*, starting on **page 244**. SKF also supplies these two sizes with a hexagon recessed into the head of the stud. They are fitted with sliding rings made of polyamide 66 and are identified by the designation suffix PPSKA. Cam followers with the designation suffix PPSKA are not equipped with a lubrication duct and cannot be relubricated (→ **fig. 23**).

KR design cam followers with the designation suffix B, sizes 22 and larger, have a recessed hexagon at each end of the stud. However, sizes 22 and 26 (→ **fig. 21**) do not have an annular groove and lubrication hole in the central part of the stud. In the centre of each hexagon is a relubrication hole to press in a grease fitting, if needed. Sizes 35 and larger can accommodate adapters from a central lubrication system. See section *Accessories*, starting on **page 244**. For cam followers from size 30 and larger, the lubricant can also be supplied via a relubrication hole with an annular groove in the seat.

### KRE design cam followers

KRE design cam followers are similar to the KR design with a PPA designation suffix. The difference is that the KRE design has an eccentric collar pressed onto the stud (→ **fig. 24**). Because the eccentric collar covers the duct in the stud, these cam followers can only be relubricated via the stud ends.

### KRV design cam followers

KRV design cam followers are similar to the KR design with a designation suffix PPA. The difference is that the KRV design has a full complement of needle rollers (→ **fig. 25**). Therefore, KRV design cam followers can accommodate heavier radial loads than KR design cam followers. However, they are not able to operate at the same high speeds and require more frequent relubrication.

Fig. 23

KR design cam follower, designation suffix PPSKA

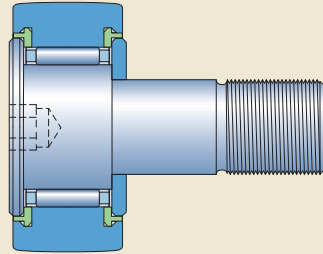

Fig. 24

KRE design cam follower, designation suffix PPA, sizes 30 and larger

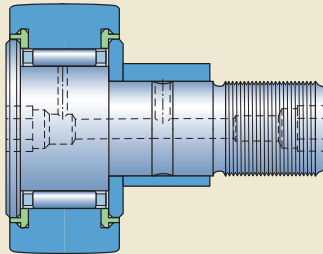
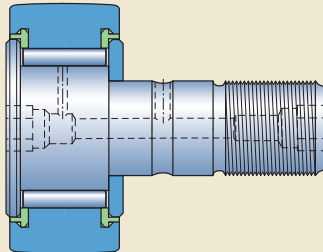

Fig. 25

KRV design cam follower, designation suffix PPA, sizes 30 and larger



## NUKR design cam followers

### NUKR .. A design cam followers

NUKR .. A design cam followers (→ **fig. 26**) are based on the design of a double row, full complement cylindrical roller bearing. The outer ring has two integral flanges that guide the roller complements axially. The stud head and a pressed-on flange ring provide axial guidance for the outer ring via the rollers. This enables NUKR .. A design cam followers to accommodate the heavy axial forces that result when operating in an inclined or tilted position and to operate at relatively high speeds.

NUKR .. A design cam followers have a recessed hexagon at each end of the stud, to enable the cam follower to be held in place by a hexagonal key (Allen wrench) during mounting. In the centre of each hexagon is a relubrication hole for a press-in grease fitting or an adapter from a central lubrication system. See section *Accessories*, starting on **page 244**. Lubricant can also be applied via the relubrication hole and the annular groove in the seat.

Sheet metal angle rings that are pressed into the outer ring and extend over the stud head and the flange ring form efficient labyrinth seals.

### NUKRE .. A design cam followers

NUKRE .. A design cam followers are similar to the NUKR .. A design. The difference is that the NUKRE .. A design has an eccentric collar pressed onto the stud (→ **fig. 27**). Because the eccentric collar covers the duct in the stud, these cam followers can only be relubricated via the stud ends.

Fig. 26

NUKR .. A design cam follower

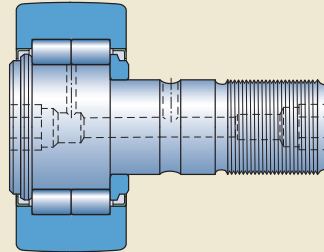
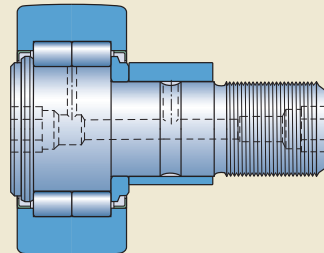

Fig. 27

NUKRE .. A design cam follower



### PWKR design cam followers

#### PWKR ...2RS design cam followers

PWKR ...2RS design cam followers (→ fig. 28) have an outer ring with three integral flanges. They axially guide the two rows of full complement rollers separately to minimize friction in the cam follower, thereby reducing the amount of heat generated by the bearing. The stud head and a pressed-on flange ring provide axial guidance for the outer ring via the rollers. This enables the cam followers to accommodate the relatively heavy constant axial loads that occur when cam followers operate in an inclined position.

PWKR ...2RS design cam followers have a contact seal of oil and wear-resistant acrylonitrile-butadiene rubber (NBR) on both sides. The seals are integral with the angle rings that are pressed in the outer ring and seal against the stud head and the flange ring. The sheet metal angle rings extend over the stud head and the flange ring to form secondary labyrinth seals, making them particularly suitable for operation under arduous conditions.

The large space between the two rows of rollers enables a large quantity of grease to be incorporated. The large grease fill and efficient sealing method make it possible to operate PWKR ...2RS design cam followers for longer periods between maintenance intervals than was previously possible, even under contaminated conditions.

They also have a recessed hexagon at both ends of the stud that enables the cam follower to be held in place by a hexagonal key (Allen wrench) during mounting. In the centre of each hexagon is a relubrication hole for a press-in grease fitting or an adapter from a central lubrication system. See section *Accessories*, starting on **page 244**. Lubricant can also be applied via the relubrication hole and the annular groove in the seat.

#### PWKRE ...2RS design cam followers

PWKRE ...2RS design cam followers are similar to PWKR ...2RS design cam followers. The difference is that the PWKRE ...2RS design has an eccentric collar pressed onto the stud (→ fig. 29). Because the eccentric collar covers the lubrication duct in the stud, these cam followers can only be relubricated via the stud ends.

Fig. 28

PWKR ...2RS design cam follower

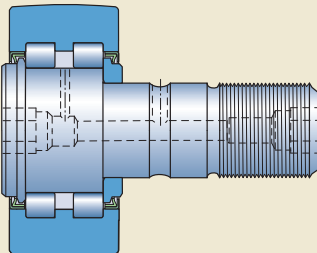
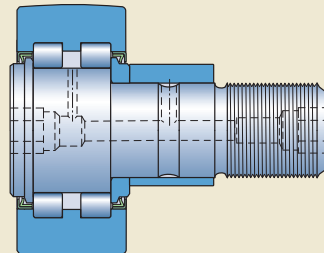

Fig. 29

PWKRE ...2RS design cam follower



## Profile of the outer ring running surface

### Crowned outer ring running surface

SKF supplies cam followers, as standard, with a crowned outer ring running surface. The crowned outer ring running surface provides good load distribution during operation when the bearing is in a tilted or inclined position.

KR design cam followers, without designation suffix or with designation suffix B, have a crowned running surface with a radius of 500 mm.

SKF also supplies cam followers with an improved crowned profile of the outer ring running surface. The modified line contact provides even better load distribution than cam followers with the standard radius. In practice, this modified line contact provides a higher degree of stiffness while reducing wear between the outer ring running surface and the track. The following cam follower designs have an improved crowned profile:

- KR design, with the designation suffixes PPA and PPSKA
- NUKR design
- PWKR design

### Cylindrical outer ring running surface

SKF recommends cam followers with a cylindrical (flat) outer ring running surface for applications requiring a high degree of stiffness and when running in a tilted or inclined position can be avoided. They are identified by the designation suffix X. These cam followers are dimensionally interchangeable with standard profile cam followers. For additional information, contact the SKF application engineering service.

## Cam followers

### Accessories

The accessories (→ **table 4**) are intended to provide SKF cam followers with reliable lubrication and location. SKF supplies grease fittings and hexagonal nuts with the cam followers as standard, however, other accessories must be ordered separately.

### Grease fittings

SKF supplies grease fittings that can be pressed into position, with each cam follower as standard (→ **table 4**). These are the only grease fittings that should be used. Dimensions are listed in **table 2**.

### Note

For KR design cam followers, sizes 16 and 19, the head of the grease fitting protrudes from the head end of the stud by 1,5 mm.

### Hexagonal nuts

SKF supplies the appropriate hexagonal nuts with each cam follower as standard. They are in accordance with ISO 4032:1999 or ISO 8673:1999. These 8.8 strength class nuts are zinc galvanized to ISO 4042:1999. Dimensions and recommended tightening torques are listed in **table 3**.

Table 2

#### Grease fittings

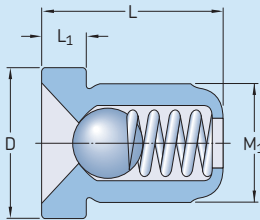

| Designation | Dimensions     |   |   |                |
|-------------|----------------|---|---|----------------|
|             | M <sub>1</sub> | D | L | L <sub>1</sub> |

mm

|            |   |     |     |     |
|------------|---|-----|-----|-----|
| NIP A1     | 4 | 6   | 6   | 1,5 |
| NIP A1×4,5 | 4 | 4,7 | 4,5 | 1   |
| NIP A2×7,5 | 6 | 7,5 | 7,5 | 2   |
| NIP A3×9,5 | 8 | 10  | 9,5 | 3   |

Table 3

#### Hexagonal nuts

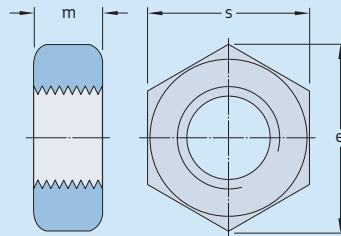

| Size | Dimensions |   |   | Tightening torque | Standard <sup>1)</sup> |
|------|------------|---|---|-------------------|------------------------|
|      | m          | e | s |                   |                        |

mm Nm

|          |      |      |    |     |   |
|----------|------|------|----|-----|---|
| M 6×1    | 5,2  | 11   | 10 | 3   | 1 |
| M 8×1,25 | 6,8  | 14,4 | 13 | 8   | 1 |
| M 10×1   | 8,4  | 17,8 | 16 | 15  | 2 |
| M 12×1,5 | 10,8 | 20   | 18 | 22  | 2 |
| M 16×1,5 | 14,8 | 26,8 | 24 | 58  | 2 |
| M 18×1,5 | 15,8 | 29,6 | 27 | 87  | 2 |
| M 20×1,5 | 18   | 33   | 30 | 120 | 2 |
| M 24×1,5 | 21,5 | 39,5 | 36 | 220 | 2 |
| M 30×1,5 | 25,6 | 50,9 | 46 | 450 | 2 |

<sup>1)</sup> 1 = EN ISO 4032:2001, ISO 4032:1999  
2 = EN ISO 8673:2001, ISO 8673:1999

Table 4

## Accessories for cam followers

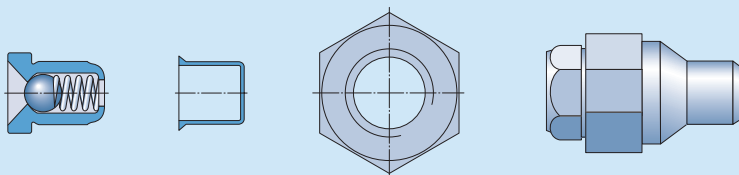

Grease fitting

Plug

Hexagonal nut

Adapter

Cam follower  
DesignSize  
without  
sealswith  
seals

## Supplied with cam follower

Grease fitting

Hexagonal  
nut

## To be ordered separately

Plug

Adapter

KR  
KRE  
KRV

|      |          |                  |            |     |       |
|------|----------|------------------|------------|-----|-------|
| 16   | 16 PPA   | NIP A1           | M 6 × 1    | VD1 | –     |
| –    | 16 PPSKA | –                | M 6 × 1    | –   | –     |
| 19   | 19 PPA   | NIP A1           | M 8 × 1,25 | VD1 | –     |
| –    | 19 PPSKA | –                | M 8 × 1,25 | –   | –     |
| 22 B | 22 PPA   | 2 × NIP A1 × 4,5 | M 10 × 1   | –   | –     |
| 26 B | 26 PPA   | 2 × NIP A1 × 4,5 | M 10 × 1   | –   | –     |
| 30 B | 30 PPA   | 2 × NIP A1 × 4,5 | M 12 × 1,5 | –   | –     |
| 32 B | 32 PPA   | 2 × NIP A1 × 4,5 | M 12 × 1,5 | –   | –     |
| 35 B | 35 PPA   | 2 × NIP A2 × 7,5 | M 16 × 1,5 | –   | AP 8  |
| 40 B | 40 PPA   | 2 × NIP A2 × 7,5 | M 18 × 1,5 | –   | AP 8  |
| –    | 47 PPA   | 2 × NIP A2 × 7,5 | M 20 × 1,5 | –   | AP 10 |
| –    | 52 PPA   | 2 × NIP A2 × 7,5 | M 20 × 1,5 | –   | AP 10 |
| –    | 62 PPA   | 2 × NIP A3 × 9,5 | M 24 × 1,5 | –   | AP 14 |
| –    | 72 PPA   | 2 × NIP A3 × 9,5 | M 24 × 1,5 | –   | AP 14 |
| –    | 80 PPA   | 2 × NIP A3 × 9,5 | M 30 × 1,5 | –   | AP 14 |
| –    | 90 PPA   | 2 × NIP A3 × 9,5 | M 30 × 1,5 | –   | AP 14 |

NUKR .. A  
NUKRE .. A  
PWKR ...2RS  
PWKRE ...2RS

|   |    |                  |            |   |       |
|---|----|------------------|------------|---|-------|
| – | 35 | 2 × NIP A2 × 7,5 | M 16 × 1,5 | – | AP 8  |
| – | 40 | 2 × NIP A2 × 7,5 | M 18 × 1,5 | – | AP 8  |
| – | 47 | 2 × NIP A2 × 7,5 | M 20 × 1,5 | – | AP 10 |
| – | 52 | 2 × NIP A2 × 7,5 | M 20 × 1,5 | – | AP 10 |
| – | 62 | 2 × NIP A3 × 9,5 | M 24 × 1,5 | – | AP 14 |
| – | 72 | 2 × NIP A3 × 9,5 | M 24 × 1,5 | – | AP 14 |
| – | 80 | 2 × NIP A3 × 9,5 | M 30 × 1,5 | – | AP 14 |
| – | 90 | 2 × NIP A3 × 9,5 | M 30 × 1,5 | – | AP 14 |

## Cam followers

### Plugs

The end of the relubrication hole in the stud of KR design cam followers, sizes 16 and 19, except those with the designation suffix PPSKA, can be plugged if relubrication is not required and if there is no space for the head of the grease fitting. Appropriate plugs with a VD1 designation must be ordered separately. The plug should be pressed into place using a mandrel (→ fig. 30).

### Adapters for connecting to a centralized lubrication system

AP design adapters enable cam followers to be relubricated via a centralized lubrication system. These adapters have a quick connection that accommodates, for example, 4x0,75 polyamide tubing in accordance with DIN 73378:1996 (→ fig. 31). The designs and dimensions are listed in table 5.

### Dimensions

The dimensions of SKF cam followers are in accordance with ISO 7063:2003 and ANSI/ABMA Standard 18.1-1982.

Table 5

#### Dimensions of adapters for connecting to a centralized lubrication system

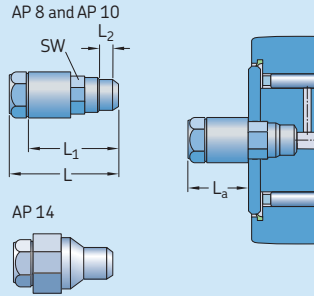

| Designation | Dimensions |                |                |                |    |
|-------------|------------|----------------|----------------|----------------|----|
|             | L          | L <sub>1</sub> | L <sub>2</sub> | L <sub>a</sub> | SW |
| — mm        |            |                |                |                |    |
| AP 8        | 27         | 22             | 4              | 16             | 8  |
| AP 10       | 27         | 22             | 5              | 15             | 10 |
| AP 14       | 25         | 20             | 6              | 8              | 14 |

Fig. 30

#### Inserting the VD1 plug with a mandrel

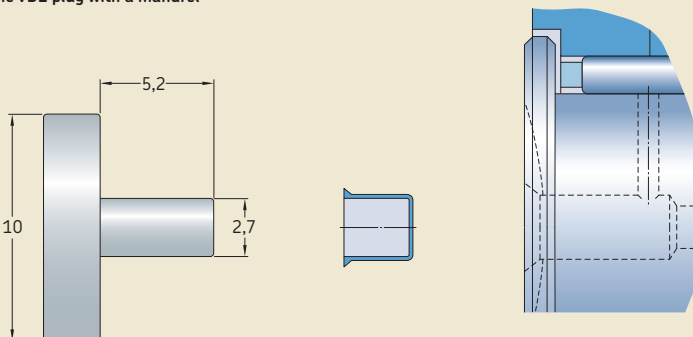



## Tolerances

The tolerances of KR, KRE and KRV design cam followers are in accordance with ISO 7063:2003. Other SKF cam followers are made to Normal tolerances in accordance with ISO 492:2002. Exceptions are:

- the tolerance of the outside diameter running surface with a crowned profile, which is 0/-0,050 mm
- the tolerance of the stud shank diameter, h7 tolerance class
- the tolerance for the eccentric collar diameter, h9 tolerance class

The limits for h7 and h9 tolerance classes are listed in **table 6**.

## Internal clearance

SKF supplies cam followers with a radial internal clearance in the range of C2 to Normal.

The clearance values are listed in **table 7** on **page 42** and are in accordance with ISO 5753-1:2009.

Table 6

### ISO tolerance classes

| Nominal diameter |       | h7         |     | h9         |     |
|------------------|-------|------------|-----|------------|-----|
| over             | incl. | Deviations |     | Deviations |     |
|                  |       | high       | low | high       | low |
| mm               |       | µm         |     | µm         |     |
| 3                | 6     | 0          | -12 | 0          | -30 |
| 6                | 10    | 0          | -15 | 0          | -36 |
| 10               | 18    | 0          | -18 | 0          | -43 |
| 18               | 30    | 0          | -21 | 0          | -52 |
| 30               | 50    | 0          | -25 | 0          | -62 |

Fig. 31

### Adapter for connection to centralized lubrication system

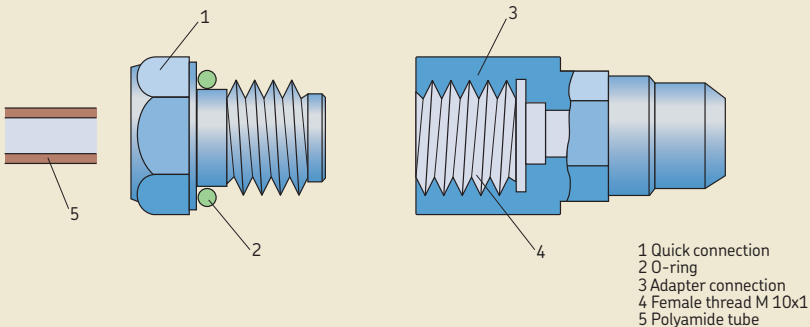

### Load carrying capacity

Compared to a typical rolling bearing, where the outer ring is fully supported in a housing, a cam follower has only a small contact area between its outer ring running surface and the track. The actual contact area depends on the applied radial load and whether the running surface is crowned or flat. The deformation of the outer ring, caused by this limited contact, alters the force distribution in the bearing, which affects load carrying capacity. The basic load ratings listed in the product tables take this into account.

The ability to accommodate dynamic loads depends on the requisite life, but it is also important to consider the strength of the outer ring, therefore, the value of the maximum dynamic radial load  $F_r$  should not be exceeded.

The permissible static load for a cam follower is determined by the smaller of the values  $F_{0r}$  and  $C_0$ . If requirements for smooth running are below normal, the static load may exceed  $C_0$  but should never exceed the maximum permissible static radial load  $F_{0r}$ .

### Permissible operating temperature

Generally, the permissible temperature range for cam followers is  $-30$  to  $+140$  °C. However, exceptions due to the seal material are:

- $-30$  to  $+100$  °C for KR design, designation suffixes PPSKA and PPA
- $-30$  to  $+120$  °C for PWKR ...2RS and PWKRE ...2RS design

Exceptions due to the applied grease must also be taken into account.

For additional information about temperature restrictions, refer to the sections *Cage materials* (→ page 44) and *Lubrication* (→ page 52).

### Lubrication

All cam followers are filled at the factory with a high-quality grease with good corrosion inhibiting properties.

Although SKF cam followers require little maintenance, they must be relubricated to achieve their full service life. This can be done via ducts in the stud (→ fig. 32):

Fig. 32

#### Possibilities for relubrication

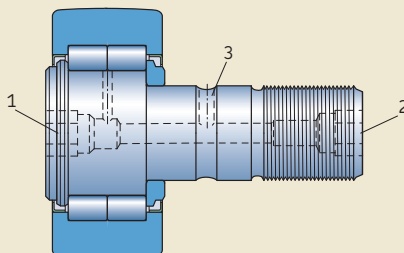

- from the head (bearing) end of the stud (1)
- from the thread end of the stud (2)
- through the relubrication hole and the annular groove in the seat on the stud shank (3)

Exceptions are:

- KR design cam followers, sizes 16 and 19, without a designation suffix or with a designation suffix PPA, which can only be relubricated via the head end
- KR design cam followers, sizes 16 and 19, designation suffix PPSKA, which cannot be relubricated
- KRE, NUKRE and PWKRE design cam followers, which can only be relubricated via the stud ends
- KR design cam followers, sizes 22 and 26, designation suffixes B or PPA, which can only be relubricated via the stud ends

SKF recommends relubrication while the initial grease fill still has its full lubricating properties. Cam followers used in applications where there are light loads, relatively low speeds and clean surroundings, can operate for long periods before relubrication is required. Cam followers that operate under contaminated and damp conditions, at high speeds or at temperatures above  $+70$  °C, require frequent relubrication. Full complement KRV and NUKR design cam followers require more frequent relubrication. SKF recommends using SKF LGWA 2 grease for relubrication.

For additional information and characteristics (→ **table 1, page 54**) of the initial grease fill and SKF LGWA 2 grease, refer to the section *Lubrication*, starting on **page 52**.

For cam followers from size 35 and larger, the lubrication ducts are also suitable for connection to a central lubrication system. See section *Accessories*, starting on **page 244**.

### Design of associated components

The flange ring that is pressed onto the stud shank should be supported axially over its entire side face. The support surface should have a diameter according to diameter  $d_1$  (→ **fig. 33**). The values for the diameter  $d_1$  are listed in the product tables. The bore through which the stud is attached should be machined to H7 tolerance class.

### Mounting instructions

Cam followers can be attached to associated components (→ **fig. 33**) using the hexagonal nuts (→ **table 3, page 244**) supplied together with the cam follower. Spring washers, which are not supplied by SKF, serve to secure the nuts.

Cam followers that are subjected to shock loads should be mounted without clearance between the stud and its bore seat. The nuts should be tightened according to the recommended torque values listed in **table 3 on page 244**. The recommended tightening torques enable the full load carrying capacity of the cam follower to be exploited. If the requisite tightening torque cannot be achieved, the stud should be mounted with an interference fit.

Most cam followers (all from size 22) have recessed hexagons and can be held with a hexagonal key (Allen wrench) while the nut is being tightened. Some designs of sizes 16 and 19 have a slot in the stud head end and can be held with a screwdriver. For additional information, refer to the illustrations in the product tables, starting on **page 252**.

Depending on the mounting conditions, cam followers with an eccentric collar can be adjusted to the required eccentricity via the slot or the recessed hexagon.

Do not hit the head of the stud as damage to the cam follower may result.

Supported flange ring

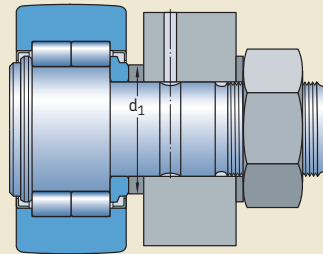

SKF recommends positioning the lubrication hole in the stud head in the unloaded zone of the cam follower. The position of this hole corresponds to the SKF trademark on the head end of the stud.

The lubrication hole (→ position 3 in **fig. 32, page 248**) that is in line with the lubrication hole in the stud head may be used to incorporate a locking device to prevent the stud from turning, or can be used for relubrication purposes. This is only possible with cam followers that do not have an eccentric collar and with KR design cam followers from size 30 and larger.

## Cam followers

### Supplementary designations

The designation suffixes used to identify certain features of SKF cam followers are explained in the following.

- .2RS** Contact seal of acrylonitrile-butadiene rubber (NBR) on both sides of the cam follower
- A** NUKR design cam followers with an improved crowned profile of the outer ring running surface
- B** KR design cam followers with a crowned profile of the outer ring running surface and a recessed hexagon on both ends of the stud
- PPA** KR design cam followers with a polyamide 66 axial sliding and sealing ring on both sides. Improved crowned profile of the outer ring running surface. Sizes 16 and 19 have one slot in the head of the stud as standard. Size 22 and larger have a recessed hexagon on both ends.
- PPSKA** KR design cam followers, sizes 16 and 19, with a polyamide 66 axial sliding and sealing ring on both sides, improved crowned profile of the outer ring running surface and hexagon recessed into the head of the stud. These cannot be relubricated.
- PPXA** Cam followers with PPA features except for the outer ring running surface, which has a cylindrical profile
- X** Cylindrical (flat) profile of the outer ring running surface
- XA** NUKR .. A and NUKRE .. A design cam followers with a cylindrical (flat) profile of the outer ring running surface



**Cam followers**  
D 16 – 32 mm

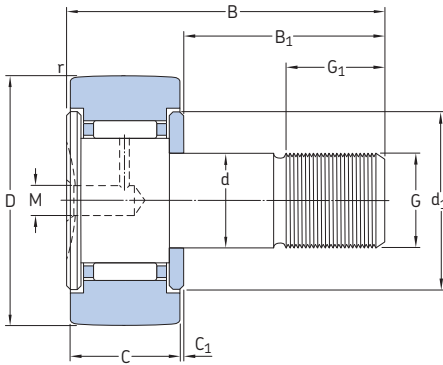

KR, sizes 16 and 19  
(KR .. PPA, sizes 16 and 19  
are with axial sliding rings)

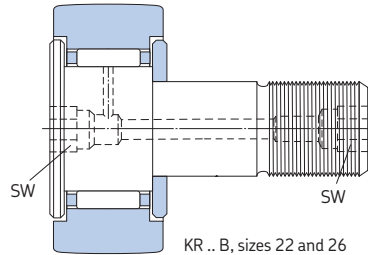
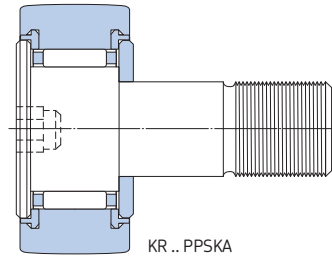

KR .. B, sizes 22 and 26  
(KR .. PPA, sizes 22 and 26  
are with axial sliding rings)

| Dimensions |    |    |    |                |                |                |                |          |                |   |                |                  |    |     | Mass           | Designation |             |
|------------|----|----|----|----------------|----------------|----------------|----------------|----------|----------------|---|----------------|------------------|----|-----|----------------|-------------|-------------|
| D          | C  | d  | B  | B <sub>1</sub> | B <sub>2</sub> | C <sub>1</sub> | d <sub>1</sub> | G        | G <sub>1</sub> | M | M <sub>1</sub> | r <sub>min</sub> | SW | c   | B <sub>3</sub> | kg          | -           |
| mm         |    |    |    |                |                |                |                |          |                |   |                |                  |    |     | kg             | -           |             |
| <b>16</b>  | 11 | 6  | 28 | 16             | -              | 0,6            | 12,5           | M 6      | 8              | 4 | -              | 0,15             | -  | -   | -              | 0,018       | KR 16       |
|            | 11 | 6  | 28 | 16             | -              | 0,6            | 12,5           | M 6      | 8              | 4 | -              | 0,15             | -  | -   | -              | 0,018       | KR 16 PPA   |
|            | 11 | 6  | 28 | 16             | -              | 0,6            | 12,5           | M 6      | 8              | - | -              | 0,15             | 4  | -   | -              | 0,018       | KR 16 PPSKA |
|            | 11 | 6  | 28 | 16             | -              | 0,6            | 12,5           | M 6      | 8              | 4 | -              | 0,15             | -  | -   | -              | 0,019       | KRV 16 PPA  |
|            | 11 | 9  | 28 | 16             | -              | 0,6            | 12,5           | M 6      | 8              | 4 | -              | 0,15             | -  | 0,5 | 7              | 0,02        | KRE 16 PPA  |
| <b>19</b>  | 11 | 8  | 32 | 20             | -              | 0,6            | 15             | M 8      | 10             | 4 | -              | 0,15             | -  | -   | -              | 0,029       | KR 19       |
|            | 11 | 8  | 32 | 20             | -              | 0,6            | 15             | M 8      | 10             | 4 | -              | 0,15             | -  | -   | -              | 0,029       | KR 19 PPA   |
|            | 11 | 8  | 32 | 20             | -              | 0,6            | 15             | M 8      | 10             | - | -              | 0,15             | 4  | -   | -              | 0,029       | KR 19 PPSKA |
|            | 11 | 8  | 32 | 20             | -              | 0,6            | 15             | M 8      | 10             | 4 | -              | 0,15             | -  | -   | -              | 0,031       | KRV 19 PPA  |
|            | 11 | 11 | 32 | 20             | -              | 0,6            | 15             | M 8      | 10             | 4 | -              | 0,15             | -  | 0,5 | 9              | 0,032       | KRE 19 PPA  |
| <b>22</b>  | 12 | 10 | 36 | 23             | -              | 0,6            | 17,5           | M 10×1   | 12             | - | -              | 0,3              | 5  | -   | -              | 0,045       | KR 22 B     |
|            | 12 | 10 | 36 | 23             | -              | 0,6            | 17,5           | M 10×1   | 12             | - | -              | 0,3              | 5  | -   | -              | 0,043       | KR 22 PPA   |
|            | 12 | 10 | 36 | 23             | -              | 0,6            | 17,5           | M 10×1   | 12             | - | -              | 0,3              | 5  | -   | -              | 0,045       | KRV 22 PPA  |
|            | 12 | 13 | 36 | 23             | -              | 0,6            | 17,5           | M 10×1   | 12             | - | -              | 0,3              | 5  | 0,5 | 10             | 0,047       | KRE 22 PPA  |
| <b>26</b>  | 12 | 10 | 36 | 23             | -              | 0,6            | 17,5           | M 10×1   | 12             | - | -              | 0,3              | 5  | -   | -              | 0,059       | KR 26 B     |
|            | 12 | 10 | 36 | 23             | -              | 0,6            | 17,5           | M 10×1   | 12             | - | -              | 0,3              | 5  | -   | -              | 0,057       | KR 26 PPA   |
|            | 12 | 10 | 36 | 23             | -              | 0,6            | 17,5           | M 10×1   | 12             | - | -              | 0,3              | 5  | -   | -              | 0,059       | KRV 26 PPA  |
|            | 12 | 13 | 36 | 23             | -              | 0,6            | 17,5           | M 10×1   | 12             | - | -              | 0,3              | 5  | 0,5 | 10             | 0,062       | KRE 26 PPA  |
| <b>30</b>  | 14 | 12 | 40 | 25             | 6              | 0,6            | 23             | M 12×1,5 | 13             | - | 3              | 0,6              | 6  | -   | -              | 0,092       | KR 30 B     |
|            | 14 | 12 | 40 | 25             | 6              | 0,6            | 23             | M 12×1,5 | 13             | - | 3              | 0,6              | 6  | -   | -              | 0,088       | KR 30 PPA   |
|            | 14 | 12 | 40 | 25             | 6              | 0,6            | 23             | M 12×1,5 | 13             | - | 3              | 0,6              | 6  | -   | -              | 0,091       | KRV 30 PPA  |
|            | 14 | 15 | 40 | 25             | 6              | 0,6            | 23             | M 12×1,5 | 13             | - | 3              | 0,6              | 6  | 0,5 | 11             | 0,093       | KRE 30 PPA  |
| <b>32</b>  | 14 | 12 | 40 | 25             | 6              | 0,6            | 23             | M 12×1,5 | 13             | - | 3              | 0,6              | 6  | -   | -              | 0,1         | KR 32 B     |
|            | 14 | 12 | 40 | 25             | 6              | 0,6            | 23             | M 12×1,5 | 13             | - | 3              | 0,6              | 6  | -   | -              | 0,1         | KR 32 PPA   |
|            | 14 | 12 | 40 | 25             | 6              | 0,6            | 23             | M 12×1,5 | 13             | - | 3              | 0,6              | 6  | -   | -              | 0,1         | KRV 32 PPA  |
|            | 14 | 15 | 40 | 25             | 6              | 0,6            | 23             | M 12×1,5 | 13             | - | 3              | 0,6              | 6  | 0,5 | 11             | 0,1         | KRE 32 PPA  |

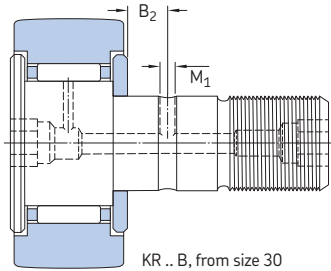

KR .. B, from size 30

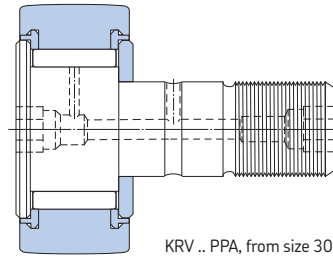

KRV .. PPA, from size 30

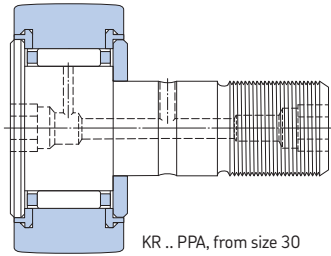

KR .. PPA, from size 30

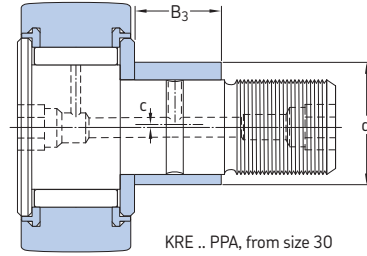

KRE .. PPA, from size 30

| Designation | Basic load ratings |                          | Fatigue load limit | Maximum radial loads      |                           | Limiting speed |
|-------------|--------------------|--------------------------|--------------------|---------------------------|---------------------------|----------------|
|             | dynamic<br>C       | static<br>C <sub>0</sub> |                    | dynamic<br>F <sub>r</sub> | static<br>F <sub>0r</sub> |                |
| –           | kN                 |                          | kN                 | kN                        |                           | r/min          |
| KR 16       | 3,14               | 3,2                      | 0,345              | 2,9                       | 4,15                      | 6 000          |
| KR 16 PPA   | 3,14               | 3,2                      | 0,345              | 2,9                       | 4,15                      | 6 000          |
| KR 16 PPSKA | 3,14               | 3,2                      | 0,345              | 2,9                       | 4,15                      | 6 000          |
| KRV 16 PPA  | 4,73               | 6,55                     | 0,72               | 4,05                      | 5,7                       | 4 300          |
| KRE 16 PPA  | 3,14               | 3,2                      | 0,345              | 2,9                       | 4,15                      | 6 000          |
| KR 19       | 3,47               | 3,8                      | 0,415              | 3,8                       | 5,5                       | 5 600          |
| KR 19 PPA   | 3,47               | 3,8                      | 0,415              | 3,8                       | 5,5                       | 5 600          |
| KR 19 PPSKA | 3,47               | 3,8                      | 0,415              | 3,8                       | 5,5                       | 5 600          |
| KRV 19 PPA  | 5,28               | 8                        | 0,88               | 5,1                       | 7,35                      | 4 000          |
| KRE 19 PPA  | 3,47               | 3,8                      | 0,415              | 3,8                       | 5,5                       | 5 600          |
| KR 22 B     | 4,4                | 5                        | 0,56               | 4,25                      | 6                         | 5 300          |
| KR 22 PPA   | 4,4                | 5                        | 0,56               | 4,25                      | 6                         | 5 300          |
| KRV 22 PPA  | 6,05               | 9,15                     | 1,04               | 5,7                       | 8,15                      | 3 600          |
| KRE 22 PPA  | 4,4                | 5                        | 0,56               | 4,25                      | 6                         | 5 300          |
| KR 26 B     | 4,84               | 6                        | 0,655              | 9,3                       | 13,2                      | 5 300          |
| KR 26 PPA   | 4,84               | 6                        | 0,655              | 9,3                       | 13,2                      | 5 300          |
| KRV 26 PPA  | 6,82               | 11                       | 1,25               | 11,4                      | 16,3                      | 3 600          |
| KRE 26 PPA  | 4,84               | 6                        | 0,655              | 9,3                       | 13,2                      | 5 300          |
| KR 30 B     | 6,44               | 8                        | 0,88               | 7,8                       | 11,2                      | 4 800          |
| KR 30 PPA   | 6,44               | 8                        | 0,88               | 7,8                       | 11,2                      | 4 800          |
| KRV 30 PPA  | 8,97               | 14,6                     | 1,66               | 11                        | 15,6                      | 3 200          |
| KRE 30 PPA  | 6,44               | 8                        | 0,88               | 7,8                       | 11,2                      | 4 800          |
| KR 32 B     | 6,71               | 8,5                      | 0,95               | 10,6                      | 15                        | 4 800          |
| KR 32 PPA   | 6,71               | 8,5                      | 0,95               | 10,6                      | 15                        | 4 800          |
| KRV 32 PPA  | 9,35               | 15,3                     | 1,76               | 14,3                      | 20,4                      | 3 200          |
| KRE 32 PPA  | 6,71               | 8,5                      | 0,95               | 10,6                      | 15                        | 4 800          |

**Cam followers**  
D 35 – 52 mm

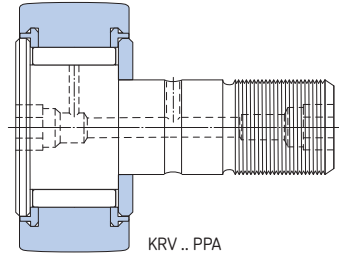
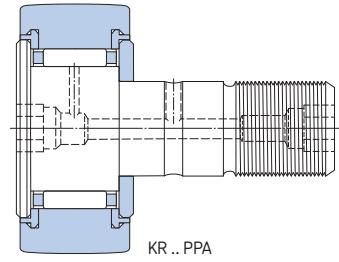
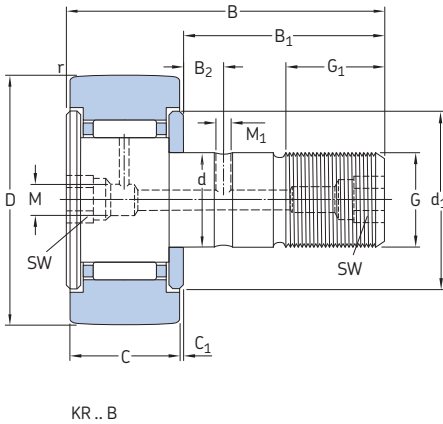

| Dimensions |    |    |    |                |                |                |                |         |                |    |                |                  |    |    | Mass           | Designation |              |            |
|------------|----|----|----|----------------|----------------|----------------|----------------|---------|----------------|----|----------------|------------------|----|----|----------------|-------------|--------------|------------|
| D          | C  | d  | B  | B <sub>1</sub> | B <sub>2</sub> | C <sub>1</sub> | d <sub>1</sub> | G       | G <sub>1</sub> | M  | M <sub>1</sub> | r <sub>min</sub> | SW | c  | B <sub>3</sub> | kg          | -            |            |
| mm         |    |    |    |                |                |                |                |         |                |    |                |                  |    |    |                |             |              |            |
| 35         | 18 | 16 | 52 | 32,5           | 8              | 0,8            | 27,6           | M16×1,5 | 17             | -  | 3              | 0,6              | 8  | -  | -              | 0,17        | KR 35 B      |            |
|            | 18 | 16 | 52 | 32,5           | 8              | 0,8            | 27,6           | M16×1,5 | 17             | -  | 3              | 0,6              | 8  | -  | -              | 0,16        | KR 35 PPA    |            |
|            | 18 | 16 | 52 | 32,5           | 8              | 0,8            | 27,6           | M16×1,5 | 17             | -  | 3              | 0,6              | 8  | -  | -              | 0,17        | KRV 35 PPA   |            |
|            | 18 | 16 | 52 | 32,5           | 8              | 0,8            | 20             | M16×1,5 | 17             | 6  | 3              | 0,6              | 8  | -  | -              | 0,16        | NUKR 35 A    |            |
|            | 18 | 16 | 52 | 32,5           | 8              | 0,8            | 20             | M16×1,5 | 17             | 6  | 3              | 0,6              | 8  | -  | -              | 0,16        | PWK 35.2RS   |            |
|            | 18 | 20 | 52 | 32,5           | 8              | 0,8            | 27,6           | M16×1,5 | 17             | -  | 3              | 0,6              | 8  | 1  | 14             | 0,18        | KRE 35 PPA   |            |
|            | 18 | 20 | 52 | 29,5           | 8              | 3,8            | 27,6           | M16×1,5 | 17             | 6  | 3              | 0,6              | 8  | 1  | 12             | 0,18        | NUKRE 35 A   |            |
|            | 18 | 20 | 52 | 29,5           | 8              | 3,8            | 27,6           | M16×1,5 | 17             | 6  | 3              | 0,6              | 8  | 1  | 12             | 0,18        | PWKRE 35.2RS |            |
|            | 40 | 20 | 18 | 58             | 36,5           | 8              | 0,8            | 31,5    | M18×1,5        | 19 | -              | 3                | 1  | 8  | -              | -           | 0,25         | KR 40 B    |
| 20         |    | 18 | 58 | 36,5           | 8              | 0,8            | 31,5           | M18×1,5 | 19             | -  | 3              | 1                | 8  | -  | -              | 0,25        | KR 40 PPA    |            |
| 20         |    | 18 | 58 | 36,5           | 8              | 0,8            | 31,5           | M18×1,5 | 19             | -  | 3              | 1                | 8  | -  | -              | 0,25        | KRV 40 PPA   |            |
| 20         |    | 18 | 58 | 36,5           | 8              | 0,8            | 22             | M18×1,5 | 19             | 6  | 3              | 1                | 8  | -  | -              | 0,24        | NUKR 40 A    |            |
| 20         |    | 18 | 58 | 36,5           | 8              | 0,8            | 22             | M18×1,5 | 19             | 6  | 3              | 1                | 8  | -  | -              | 0,24        | PWK 40.2RS   |            |
| 20         |    | 22 | 58 | 36,5           | 8              | 0,8            | 31,5           | M18×1,5 | 19             | -  | 3              | 1                | 8  | 1  | 16             | 0,26        | KRE 40 PPA   |            |
| 20         |    | 22 | 58 | 33,5           | 8              | 3,8            | 30             | M18×1,5 | 19             | 6  | 3              | 1                | 8  | 1  | 14             | 0,26        | NUKRE 40 A   |            |
| 20         |    | 22 | 58 | 33,5           | 8              | 3,8            | 30             | M18×1,5 | 19             | 6  | 3              | 1                | 8  | 1  | 14             | 0,26        | PWKRE 40.2RS |            |
| 47         |    | 24 | 20 | 66             | 40,5           | 9              | 0,8            | 36,5    | M20×1,5        | 21 | 8              | 4                | 1  | 10 | -              | -           | 0,38         | KR 47 PPA  |
|            | 24 | 20 | 66 | 40,5           | 9              | 0,8            | 36,5           | M20×1,5 | 21             | 8  | 4              | 1                | 10 | -  | -              | 0,39        | KRV 47 PPA   |            |
|            | 24 | 20 | 66 | 40,5           | 9              | 0,8            | 27             | M20×1,5 | 21             | 6  | 4              | 1                | 10 | -  | -              | 0,38        | NUKR 47 A    |            |
|            | 24 | 20 | 66 | 40,5           | 9              | 0,8            | 27             | M20×1,5 | 21             | 6  | 4              | 1                | 10 | -  | -              | 0,38        | PWK 47.2RS   |            |
|            | 24 | 24 | 66 | 40,5           | 9              | 0,8            | 36,5           | M20×1,5 | 21             | 8  | 4              | 1                | 10 | 1  | 18             | 0,41        | KRE 47 PPA   |            |
|            | 24 | 24 | 66 | 40,5           | 9              | 0,8            | 27             | M20×1,5 | 21             | 6  | 4              | 1                | 10 | 1  | 18             | 0,4         | NUKRE 47 A   |            |
|            | 24 | 24 | 66 | 40,5           | 9              | 0,8            | 27             | M20×1,5 | 21             | 6  | 4              | 1                | 10 | 1  | 18             | 0,4         | PWKRE 47.2RS |            |
|            | 52 | 24 | 20 | 66             | 40,5           | 9              | 0,8            | 36,5    | M20×1,5        | 21 | 8              | 4                | 1  | 10 | -              | -           | 0,45         | KR 52 PPA  |
|            |    | 24 | 20 | 66             | 40,5           | 9              | 0,8            | 36,5    | M20×1,5        | 21 | 8              | 4                | 1  | 10 | -              | -           | 0,46         | KRV 52 PPA |
| 24         |    | 20 | 66 | 40,5           | 9              | 0,8            | 31             | M20×1,5 | 21             | 8  | 4              | 1                | 10 | -  | -              | 0,45        | NUKR 52 A    |            |
| 24         |    | 20 | 66 | 40,5           | 9              | 0,8            | 31             | M20×1,5 | 21             | 8  | 4              | 1                | 10 | -  | -              | 0,45        | PWK 52.2RS   |            |
| 24         |    | 24 | 66 | 40,5           | 9              | 0,8            | 36,5           | M20×1,5 | 21             | 8  | 4              | 1                | 10 | 1  | 18             | 0,47        | KRE 52 PPA   |            |
| 24         |    | 24 | 66 | 40,5           | 9              | 0,8            | 31             | M20×1,5 | 21             | 8  | 4              | 1                | 10 | 1  | 18             | 0,47        | NUKRE 52 A   |            |
| 24         |    | 24 | 66 | 40,5           | 9              | 0,8            | 31             | M20×1,5 | 21             | 8  | 4              | 1                | 10 | 1  | 18             | 0,47        | PWKRE 52.2RS |            |



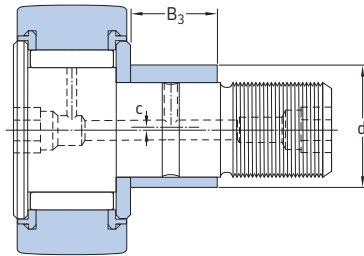

KRE .. PPA

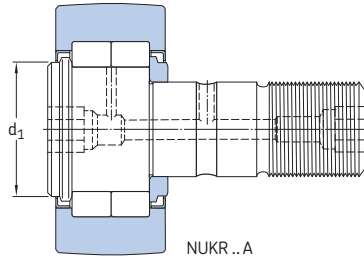

NUKR .. A  
(NUKRE .. A have an eccentric collar)

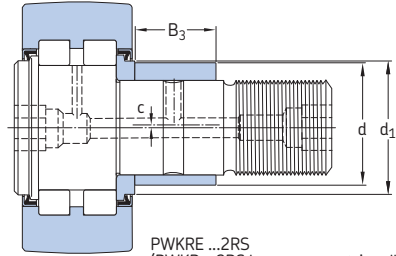

PWKRE ...2RS  
(PWKR ...2RS have a concentric collar)

| Designation  | Basic load ratings |                          | Fatigue load limit | Maximum radial loads      |                           | Limiting speed |
|--------------|--------------------|--------------------------|--------------------|---------------------------|---------------------------|----------------|
|              | dynamic<br>C       | static<br>C <sub>0</sub> |                    | dynamic<br>F <sub>r</sub> | static<br>F <sub>0r</sub> |                |
| –            | kN                 |                          | kN                 | kN                        |                           | r/min          |
| KR 35 B      | 9,52               | 13,7                     | 1,56               | 11,4                      | 16,3                      | 4 000          |
| KR 35 PPA    | 9,52               | 13,7                     | 1,56               | 11,4                      | 16,3                      | 4 000          |
| KRV 35 PPA   | 12,3               | 23,2                     | 2,7                | 14,6                      | 20,8                      | 2 600          |
| NUKR 35 A    | 16,8               | 17,6                     | 2                  | 8,65                      | 12,2                      | 5 000          |
| PWKR 35.2RS  | 11,9               | 11,4                     | 1,2                | 8,65                      | 12,5                      | 5 000          |
| KRE 35 PPA   | 9,52               | 13,7                     | 1,56               | 11,4                      | 16,3                      | 4 000          |
| NUKRE 35 A   | 16,8               | 17,6                     | 2                  | 8,65                      | 12,2                      | 5 000          |
| PWKRE 35.2RS | 11,9               | 11,4                     | 1,2                | 8,65                      | 12,5                      | 5 000          |
| KR 40 B      | 10,5               | 14,6                     | 1,73               | 12,5                      | 18                        | 3 400          |
| KR 40 PPA    | 10,5               | 14,6                     | 1,73               | 12,5                      | 18                        | 3 400          |
| KRV 40 PPA   | 14,2               | 26,5                     | 3,1                | 17                        | 24,5                      | 2 200          |
| NUKR 40 A    | 19                 | 22                       | 2,5                | 14                        | 20                        | 4 500          |
| PWKR 40.2RS  | 13,8               | 14,3                     | 1,5                | 13,7                      | 19,6                      | 4 500          |
| KRE 40 PPA   | 10,5               | 14,6                     | 1,73               | 12,5                      | 18                        | 3 400          |
| NUKRE 40 A   | 19                 | 22                       | 2,5                | 14                        | 20                        | 4 500          |
| PWKRE 40.2RS | 13,8               | 14,3                     | 1,5                | 13,7                      | 19,6                      | 4 500          |
| KR 47 PPA    | 14,7               | 24,5                     | 2,9                | 23,6                      | 33,5                      | 3 000          |
| KRV 47 PPA   | 19,4               | 41,5                     | 5                  | 30,5                      | 43                        | 1 900          |
| NUKR 47 A    | 28,6               | 33,5                     | 3,9                | 17,6                      | 25                        | 3 800          |
| PWKR 47.2RS  | 22,9               | 24,5                     | 2,8                | 18,3                      | 26                        | 3 800          |
| KRE 47 PPA   | 14,7               | 24,5                     | 2,9                | 23,6                      | 33,5                      | 3 000          |
| NUKRE 47 A   | 28,6               | 33,5                     | 3,9                | 17,6                      | 25                        | 3 800          |
| PWKRE 47.2RS | 22,9               | 24,5                     | 2,8                | 18,3                      | 26                        | 3 800          |
| KR 52 PPA    | 15,7               | 27                       | 3,2                | 36                        | 51                        | 3 000          |
| KRV 52 PPA   | 20,9               | 46,5                     | 5,6                | 45                        | 64                        | 1 900          |
| NUKR 52 A    | 29,7               | 36                       | 4,25               | 18                        | 25,5                      | 3 200          |
| PWKR 52.2RS  | 23,8               | 26,5                     | 3,05               | 18,6                      | 26,5                      | 3 200          |
| KRE 52 PPA   | 15,7               | 27                       | 3,2                | 36                        | 51                        | 3 000          |
| NUKRE 52 A   | 29,7               | 36                       | 4,25               | 18                        | 25,5                      | 3 200          |
| PWKRE 52.2RS | 23,8               | 26,5                     | 3,05               | 18,6                      | 26,5                      | 3 200          |

**Cam followers**  
**D 62 – 90 mm**

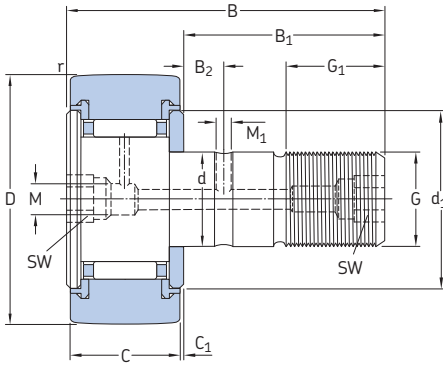

KR .. PPA

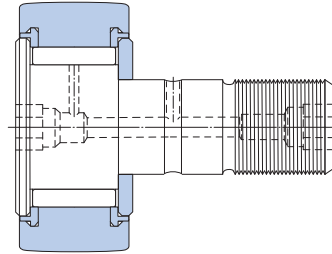

KRV .. PPA

| Dimensions |    |    |     |                |                |                |                |          |                |   |                |                  |    |     | Mass           | Designation |              |
|------------|----|----|-----|----------------|----------------|----------------|----------------|----------|----------------|---|----------------|------------------|----|-----|----------------|-------------|--------------|
| D          | C  | d  | B   | B <sub>1</sub> | B <sub>2</sub> | C <sub>1</sub> | d <sub>1</sub> | G        | G <sub>1</sub> | M | M <sub>1</sub> | r <sub>min</sub> | SW | c   | B <sub>3</sub> |             |              |
| mm         |    |    |     |                |                |                |                |          |                |   |                |                  |    |     |                | kg          | -            |
| <b>62</b>  | 29 | 24 | 80  | 49,5           | 11             | 0,8            | 44             | M 24×1,5 | 25             | 8 | 4              | 1                | 14 | -   | -              | 0,77        | KR 62 PPA    |
|            | 29 | 24 | 80  | 49,5           | 11             | 0,8            | 44             | M 24×1,5 | 25             | 8 | 4              | 1                | 14 | -   | -              | 0,79        | KRV 62 PPA   |
|            | 28 | 24 | 80  | 49,5           | 11             | 1,3            | 38             | M 24×1,5 | 25             | 8 | 4              | 1                | 14 | -   | -              | 0,8         | NUKR 62 A    |
|            | 28 | 24 | 80  | 49,5           | 11             | 1,3            | 38             | M 24×1,5 | 25             | 8 | 4              | 1                | 14 | -   | -              | 0,8         | PWKR 62.2RS  |
|            | 29 | 28 | 80  | 49,5           | 11             | 0,8            | 44             | M 24×1,5 | 25             | 8 | 4              | 1                | 14 | 1   | 22             | 0,8         | KRE 62 PPA   |
|            | 28 | 28 | 80  | 49,5           | 11             | 1,3            | 38             | M 24×1,5 | 25             | 8 | 4              | 1                | 14 | 1   | 22             | 0,82        | NUKRE 62 A   |
|            | 28 | 28 | 80  | 49,5           | 11             | 1,3            | 38             | M 24×1,5 | 25             | 8 | 4              | 1                | 14 | 1   | 22             | 0,82        | PWKRE 62.2RS |
| <b>72</b>  | 29 | 24 | 80  | 49,5           | 11             | 0,8            | 44             | M 24×1,5 | 25             | 8 | 4              | 1,1              | 14 | -   | -              | 1,01        | KR 72 PPA    |
|            | 29 | 24 | 80  | 49,5           | 11             | 0,8            | 44             | M 24×1,5 | 25             | 8 | 4              | 1,1              | 14 | -   | -              | 1,03        | KRV 72 PPA   |
|            | 28 | 24 | 80  | 49,5           | 11             | 1,3            | 44             | M 24×1,5 | 25             | 8 | 4              | 1,1              | 14 | -   | -              | 1,02        | NUKR 72 A    |
|            | 28 | 24 | 80  | 49,5           | 11             | 1,3            | 44             | M 24×1,5 | 25             | 8 | 4              | 1,1              | 14 | -   | -              | 1,02        | PWKR 72.2RS  |
|            | 29 | 28 | 80  | 49,5           | 11             | 0,8            | 44             | M 24×1,5 | 25             | 8 | 4              | 1,1              | 14 | 1   | 22             | 1,04        | KRE 72 PPA   |
|            | 28 | 28 | 80  | 49,5           | 11             | 1,3            | 44             | M 24×1,5 | 25             | 8 | 4              | 1,1              | 14 | 1   | 22             | 1,05        | NUKRE 72 A   |
|            | 28 | 28 | 80  | 49,5           | 11             | 1,3            | 44             | M 24×1,5 | 25             | 8 | 4              | 1,1              | 14 | 1   | 22             | 1,05        | PWKRE 72.2RS |
| <b>80</b>  | 35 | 30 | 100 | 63             | 15             | 1              | 53             | M 30×1,5 | 32             | 8 | 4              | 1,1              | 14 | -   | -              | 1,61        | KR 80 PPA    |
|            | 35 | 30 | 100 | 63             | 15             | 1              | 53             | M 30×1,5 | 32             | 8 | 4              | 1,1              | 14 | -   | -              | 1,64        | KRV 80 PPA   |
|            | 35 | 30 | 100 | 63             | 15             | 1              | 47             | M 30×1,5 | 32             | 8 | 4              | 1,1              | 14 | -   | -              | 1,6         | NUKR 80 A    |
|            | 35 | 30 | 100 | 63             | 15             | 1              | 47             | M 30×1,5 | 32             | 8 | 4              | 1,5              | 14 | -   | -              | 1,6         | PWKR 80.2RS  |
|            | 35 | 35 | 100 | 63             | 15             | 1              | 53             | M 30×1,5 | 32             | 8 | 4              | 1,1              | 14 | 1,5 | 29             | 1,67        | KRE 80 PPA   |
|            | 35 | 35 | 100 | 63             | 15             | 1              | 47             | M 30×1,5 | 32             | 8 | 4              | 1,1              | 14 | 1,5 | 29             | 1,67        | NUKRE 80 A   |
|            | 35 | 35 | 100 | 63             | 15             | 1              | 47             | M 30×1,5 | 32             | 8 | 4              | 1,5              | 14 | 1,5 | 29             | 1,67        | PWKRE 80.2RS |
| <b>90</b>  | 35 | 30 | 100 | 63             | 15             | 1              | 53             | M 30×1,5 | 32             | 8 | 4              | 1,1              | 14 | -   | -              | 1,98        | KR 90 PPA    |
|            | 35 | 30 | 100 | 63             | 15             | 1              | 53             | M 30×1,5 | 32             | 8 | 4              | 1,1              | 14 | -   | -              | 2           | KRV 90 PPA   |
|            | 35 | 30 | 100 | 63             | 15             | 1              | 47             | M 30×1,5 | 32             | 8 | 4              | 1,1              | 14 | -   | -              | 1,96        | NUKR 90 A    |
|            | 35 | 30 | 100 | 63             | 15             | 1              | 47             | M 30×1,5 | 32             | 8 | 4              | 1,5              | 14 | -   | -              | 1,96        | PWKR 90.2RS  |
|            | 35 | 35 | 100 | 63             | 15             | 1              | 53             | M 30×1,5 | 32             | 8 | 4              | 1,1              | 14 | 1,5 | 29             | 2,03        | KRE 90 PPA   |
|            | 35 | 35 | 100 | 63             | 15             | 1              | 47             | M 30×1,5 | 32             | 8 | 4              | 1,1              | 14 | 1,5 | 29             | 2,02        | NUKRE 90 A   |
|            | 35 | 35 | 100 | 63             | 15             | 1              | 47             | M 30×1,5 | 32             | 8 | 4              | 1,5              | 14 | 1,5 | 29             | 2,02        | PWKRE 90.2RS |

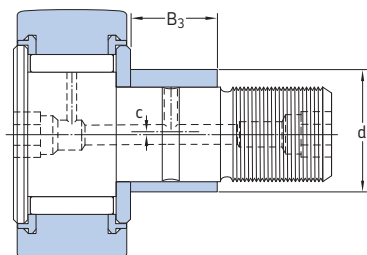

KRE .. PPA

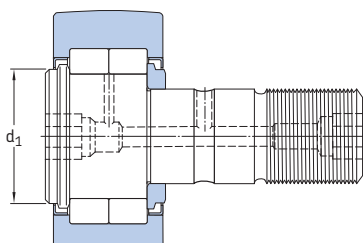

NUKR ... A  
(NUKRE ... A have an eccentric collar)

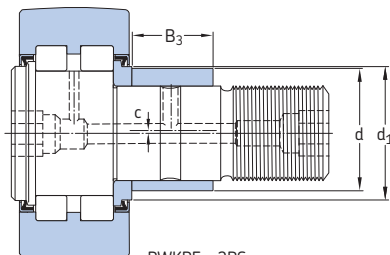

PWKRE ... 2RS  
(PWKR ... 2RS have a concentric collar)

| Designation  | Basic load ratings |                          | Fatigue load limit | Maximum radial loads      |                           | Limiting speed |
|--------------|--------------------|--------------------------|--------------------|---------------------------|---------------------------|----------------|
|              | dynamic<br>C       | static<br>C <sub>0</sub> |                    | dynamic<br>F <sub>r</sub> | static<br>F <sub>0r</sub> |                |
| –            | kN                 |                          | kN                 | kN                        |                           | r/min          |
| KR 62 PPA    | 24,6               | 44                       | 5,5                | 58,5                      | 85                        | 2 400          |
| KRV 62 PPA   | 31,4               | 72                       | 9                  | 72                        | 102                       | 1 700          |
| NUKR 62 A    | 41,3               | 48                       | 5,85               | 25                        | 36                        | 2 600          |
| PWKR 62.2RS  | 31,9               | 32,5                     | 4,05               | 20,4                      | 29                        | 2 600          |
| KRE 62 PPA   | 24,6               | 44                       | 5,5                | 58,5                      | 85                        | 2 400          |
| NUKRE 62 A   | 41,3               | 48                       | 5,85               | 25                        | 36                        | 2 600          |
| PWKRE 62.2RS | 31,9               | 32,5                     | 4,05               | 20,4                      | 29                        | 2 600          |
| KR 72 PPA    | 26                 | 48                       | 6                  | 100                       | 143                       | 2 400          |
| KRV 72 PPA   | 33                 | 80                       | 9,8                | 118                       | 170                       | 1 700          |
| NUKR 72 A    | 45,7               | 58,5                     | 7,1                | 34,5                      | 50                        | 2 000          |
| PWKR 72.2RS  | 39,6               | 45                       | 5,6                | 47,5                      | 68                        | 2 600          |
| KRE 72 PPA   | 26                 | 48                       | 6                  | 100                       | 143                       | 2 400          |
| NUKRE 72 A   | 45,7               | 58,5                     | 7,1                | 34,5                      | 50                        | 2 000          |
| PWKRE 72.2RS | 39,6               | 45                       | 5,6                | 47,5                      | 68                        | 2 600          |
| KR 80 PPA    | 36,9               | 72                       | 9                  | 106                       | 150                       | 1 800          |
| KRV 80 PPA   | 45,7               | 114                      | 14                 | 122                       | 176                       | 1 400          |
| NUKR 80 A    | 69,3               | 86,5                     | 10,8               | 48                        | 69,5                      | 1 900          |
| PWKR 80.2RS  | 57,2               | 73,5                     | 9,3                | 64                        | 91,5                      | 2 000          |
| KRE 80 PPA   | 36,9               | 72                       | 9                  | 106                       | 150                       | 1 800          |
| NUKRE 80 A   | 69,3               | 86,5                     | 10,8               | 48                        | 69,5                      | 1 900          |
| PWKRE 80.2RS | 57,2               | 73,5                     | 9,3                | 64                        | 91,5                      | 2 000          |
| KR 90 PPA    | 38                 | 76,5                     | 9,5                | 160                       | 228                       | 1 800          |
| KRV 90 PPA   | 47,3               | 122                      | 15                 | 183                       | 260                       | 1 400          |
| NUKR 90 A    | 78,1               | 102                      | 12,7               | 86,5                      | 125                       | 1 900          |
| PWKR 90.2RS  | 62,7               | 85                       | 10,8               | 108                       | 153                       | 2 000          |
| KRE 90 PPA   | 38                 | 76,5                     | 9,5                | 160                       | 228                       | 1 800          |
| NUKRE 90 A   | 78,1               | 102                      | 12,7               | 86,5                      | 125                       | 1 900          |
| PWKRE 90.2RS | 62,7               | 85                       | 10,8               | 108                       | 153                       | 2 000          |

## Product index

| Designation | Product                                                                                  | Product table/<br>table | Page |
|-------------|------------------------------------------------------------------------------------------|-------------------------|------|
| AP          | Adapters, accessories for cam followers                                                  | 4                       | 245  |
| AS          | Thrust washers                                                                           | 6.1, 6.2                | 162  |
| AXK         | Needle roller and cage thrust assemblies                                                 | 6.1                     | 162  |
| AXW         | Needle roller thrust bearings with a centring spigot                                     | 6.2                     | 166  |
| BK          | Drawn cup needle roller bearings with a closed end                                       | 3.1                     | 82   |
| G           | Radial shaft seals with a low cross sectional height                                     | 8.3                     | 212  |
| GS 811      | Housing washers                                                                          | 6.1                     | 163  |
| HK          | Drawn cup needle roller bearings with an open end                                        | 3.1                     | 82   |
| HN          | Full complement drawn cup needle roller bearings with an open end                        | 3.1                     | 84   |
| IR          | Needle roller bearing inner rings                                                        | 8.1                     | 200  |
| K           | Needle roller and cage assemblies                                                        | 2.1                     | 64   |
| KR          | Cam followers                                                                            | 9.4                     | 252  |
| KRE         | Cam followers, with an eccentric collar                                                  | 9.4                     | 252  |
| KRV         | Cam followers, with a full complement roller set                                         | 9.4                     | 252  |
| LR          | Needle roller bearing inner rings                                                        | 8.1                     | 200  |
| LS          | Raceway washers                                                                          | 6.1, 6.2                | 163  |
| NA 22       | Support rollers without flange rings, with an inner ring                                 | 9.2                     | 228  |
| NA 48       | Needle roller bearings with machined rings with flanges, with an inner ring              | 4.2                     | 130  |
| NA 49       | Needle roller bearings with machined rings with flanges, with an inner ring              | 4.2                     | 122  |
| NA 69       | Needle roller bearings with machined rings with flanges, with an inner ring              | 4.2                     | 122  |
| NAO         | Needle roller bearings with machined rings without flanges, with an inner ring           | 4.4                     | 138  |
| NATR        | Support rollers with flange rings, with an inner ring                                    | 9.3                     | 230  |
| NATV        | Support rollers with flange rings, with an inner ring, with a full complement roller set | 9.3                     | 230  |
| NK          | Needle roller bearings with machined rings with flanges, without an inner ring           | 4.1                     | 106  |
| NKI         | Needle roller bearings with machined rings with flanges, with an inner ring              | 4.2                     | 122  |
| NKIA 59     | Needle roller / angular contact ball bearings                                            | 7.1                     | 174  |
| NKIB 59     | Needle roller / angular contact ball bearings                                            | 7.1                     | 174  |
| NKIS        | Needle roller bearings with machined rings with flanges, with an inner ring              | 4.2                     | 122  |
| NKS         | Needle roller bearings with machined rings with flanges, without an inner ring           | 4.1                     | 108  |
| NKX         | Needle roller / thrust ball bearings, thrust bearing with a cage                         | 7.3                     | 186  |
| NKXR        | Needle roller / cylindrical roller thrust bearings                                       | 7.4                     | 192  |
| NNTR        | Support rollers with flange rings, with an inner ring                                    | 9.3                     | 234  |
| NUKR        | Cam followers                                                                            | 9.4                     | 254  |
| NUKRE       | Cam followers, with an eccentric collar                                                  | 9.4                     | 254  |
| NUTR        | Support rollers with flange rings, with an inner ring                                    | 9.3                     | 230  |
| NX          | Needle roller / thrust ball bearings, full complement thrust bearing                     | 7.2                     | 184  |
| PNA         | Alignment needle roller bearings with an inner ring                                      | 5.2                     | 148  |
| PWKR        | Cam followers                                                                            | 9.4                     | 254  |
| PWKRE       | Cam followers, with an eccentric collar                                                  | 9.4                     | 254  |
| PWTR        | Support rollers with flange rings, with an inner ring                                    | 9.3                     | 230  |
| RN          | Needle rollers                                                                           | 8.2                     | 206  |
| RNA 22      | Support rollers without flange rings, without an inner ring                              | 9.1                     | 226  |
| RNA 48      | Needle roller bearings with machined rings with flanges, without an inner ring           | 4.1                     | 118  |
| RNA 49      | Needle roller bearings with machined rings with flanges, without an inner ring           | 4.1                     | 106  |
| RNA 69      | Needle roller bearings with machined rings with flanges, without an inner ring           | 4.1                     | 106  |
| RNAO        | Needle roller bearings with machined rings without flanges, without an inner ring        | 4.3                     | 134  |
| RPNA        | Alignment needle roller bearings without an inner ring                                   | 5.1                     | 146  |
| RSTO        | Support rollers without flange rings, without an inner ring                              | 9.1                     | 226  |
| SD          | Radial shaft seals with a low cross sectional height                                     | 8.3                     | 212  |
| STO         | Support rollers without flange rings, with an inner ring                                 | 9.2                     | 228  |
| VD1         | Plug, accessory for cam followers                                                        | 4                       | 245  |
| WS 811      | Shaft washers                                                                            | 6.1, 6.2                | 163  |



